

RADIO'S GREATEST MAGAZINE

RADIO NEWS

REG. U.S. PAT. OFF.

AUGUST
25 CENTS

ARTHUR H. LYNCH
Editorial Director



"THE S-W FOUR"
A New Departure in Short-Wave
Receiver Construction

BY SAMUEL EGERT

HOWARD BROWN

TRIAD INSURANCE

sells more tubes...protects your profits

Tube insurance — a radically new Triad sales idea! A printed guarantee of six months' perfect service — or a satisfactory adjustment made — with every Triad Tube. Now — for the first time the dealer can be *sure* of greater tube sales and profit protection!



The TR...
give ex...
We un...
care is...
If dur...
within six...
new tube.
This guar...
street's at one

DEALER'S NAME _____
ADDRESS _____
DATE _____

RED
QUALITY SERVICE
GUARANTEE

CERTIFICATE

No. _____
This tube has been carefully tested at the factory before shipping and should give good service for a minimum period of six months from date hereof. If re-loaded, an average life of one year or more may reasonably be expected. Satisfactory for any cause (except for breakage of glass), and it is returned to the Dealer from whom it was purchased, such dealer will replace it with a new tube of equal or better quality.
TRIAD Manufacturing Co., Inc., of Pawtucket, Rhode Island, rated in Dun's and Bradstreet as your assurance of living up to its promises.

TRIAD MANUFACTURING CO., INC.
George Coby President

When a tube is backed by a printed certificate guaranteeing six months of perfect service, *it must be good!* Tube purchasers realize it — that's the reason for the tremendous popularity of Triad. And that's why dealers are winning greater sales with Triad than they have ever enjoyed before. But that's only the first step — Triad does *more than that* for the dealer — it *protects the profits he has won*. The insured certificate assures him and his customer of absolute satisfaction should an adjustment be necessary. He retains every cent of profit that he has made in the sale! No wonder dealers are enthusiastic about this line. For sales, satisfaction and protected profits, it will pay you to stock Triad!

Call your Jobber or write us for complete Triad dealer information

TRIAD MANUFACTURING CO., Inc.
Triad Building Blackstone, Middle and Fountain Sts.
PAWTUCKET, R. I.



Unique triangular Triad carton. Builds up into a striking attention-getting display. Use Triad cartons in your windows and on your counter to link up with Triad national magazine, newspaper and radio advertising.

Each of these plans, developed by the Radio Association of America, is a big money-maker. Set owners everywhere want to get rid of static, to have their sets operate from the electric light socket, the tone improved, and the volume increased, and transformed into single-dial controls. Phonograph owners want their machines electrified and radiofied. If you learn to render these services, you can easily make \$3.00 an hour for your spare time, to say nothing of the money you can make installing, servicing, repairing, building radio sets, and selling supplies.

Over \$600,000,000 is being spent yearly for sets, supplies, service. You can get your share of this business and, at the same time, fit yourself for the big-pay opportunities in Radio by joining the Association.

Join the Radio Training Association of America

A membership in the Association offers you the easiest way into Radio. It will enable you to earn \$3.00 an hour upwards in your spare time—train you to install, repair and build all kinds of sets—start you in business without capital or finance an invention—train you for the \$3,000 to \$10,000 big-pay radio positions—help secure a better position at bigger pay for you.

A membership need not cost you a cent!
The Association will give you a comprehensive, practical, and theoretical training and the benefit of its Employment Service. You earn while you learn. Our cooperative plan will make it possible for you to establish a radio store. You have the privilege of buying radio supplies at wholesale from the very first.

Earned \$500.00 Spare Time
Frank J. Deutsch, Penn.: "I have made over \$500 out of Radio in my spare time."

Radio Engineer in One Year
Claude De Grave, Canada: "I knew nothing about Radio when I joined a year ago. I am now a member of a very exclusive organization of Radio Engineers, and my income is 225% greater than it was."

Doubles Income in 6 Months
W. E. Thon, Chicago: "Six months after I enrolled I secured the managership of large Radio Store and doubled my income."

ACT NOW — If You Wish the No-Cost Membership Plan

To a limited number of ambitious men, we will give Special Memberships that may not—need not—cost you a cent. To secure one, write today. We will send you details and also our Radio Handbook filled with dollars-and-cents radio ideas. It will open your eyes to the money-making possibilities of Radio.

Radio Training Association of America
4513 Ravenswood Ave., Dept. RN-8, Chicago, Ill.

Radio Training Association of America
Dept. RN-8, 4513 Ravenswood Ave., Chicago, Ill.

Gentlemen: Please send me by return mail full details of your Special Membership Plan, and also copy of your Radio Handbook,

Name.....

Address.....

City..... State.....

Radio News

Volume XI

CONTENTS FOR AUGUST, 1929

No. 2

W. THOMSON LEES
Managing Editor

ARTHUR H. LYNCH, Editorial Director
JOHN B. BRENNAN, JR.,
Technical Editor

EDWARD W. WILBY
Associate Editor

Cover —From a Painting by Howard V. Brown	
Frontispiece: Radio's Tomorrow	100
Editorial: Coöperative Competition	102
Current Comment	104
Notes, news flashes and interpretations of the month's developments.	
The S-W Four	108
By SAMUEL EGERT—A completely shielded short-wave set embodying novel, but sound, constructional features. Embraces a tuned screen grid input, regenerative detector, two stages of high quality transformer coupled audio amplification and plug-in coils covering wavelengths from 17 to 600 meters.	
Synchronization Is Still a Television Problem	115
By THOMAS W. BENSON.	
Radio—The Graf Zeppelin's Only Contact With the World	116
By T. G. W. SETTLE, LIEUT., U. S. N.—A description of what radio means to the big dirigible, by a man who has spent the past five years in that field.	
Sound Amplifiers Invade New Fields	120
By S. GORDON TAYLOR—An outgrowth of radio development, sound amplifiers are almost daily finding new applications.	
What Are the Facts About Television?	124
By ARTHUR H. LYNCH and DR. C. FRANCIS JENKINS—The first in a series of articles on a development which is neither "just around the corner" nor by any means dead.	
Putting the Portables Through Their Paces	128
By WM. H. WENSTROM, LIEUT., SIGNAL CORPS, U. S. A.—A running account of further practical experiments with the portable transmitter and receiver described in our last issue.	
The Analogy Between Radio and the Talking Pictures	132
By CARL DREHER—An analysis by a man who not only knows the problems in both fields, but who has a happy faculty for interpreting them in plain language.	
The War Correspondent Takes to the Air	136
By ZEH BOUCK—How aviation and radio played a major part in the recent army maneuvers.	
The Theory and Design of Band-Pass Filters	140
By JOHN RIDER—First of a series of practical articles on the design and actual construction of band-pass filters for both fixed and variable tuning.	
Radio Locates Buried Treasure	142
By CHARLES E. CHAPEL—How a former British naval officer is applying radio principles to locate treasure buried at Old Panama City over 250 years ago.	
Which Power Tube Shall I Use?	146
By JAMES MARTIN—An analysis of the present available types of power output tubes, in straight and push-pull circuits—translated into terms of undistorted volume.	
The Realization of an Aviation-Radio Idea	150
By LLOYD JACQUET.	
The Radio Forum	152
A meeting place for the experimenter, serviceman, and short-wave enthusiast.	
The Trade Broadcasts:	160
Seen at the R. M. A. Show—new equipment and manufacturing trends.	
Communication Securities	168
By ALFRED M. CADDELL—The investment phase of the rapidly shifting developments in the communication field.	
Canada's New Automatic Radio Beacons for Marine Service	174
By JAMES MONTAGNES.	
The Use of Electrolytic Condensers in "B"-Power Supply Devices	176
By R. U. CLARK, 3RD.	

(Advertisers' Index will be found on page 188)

Published Monthly by the Experimenter Publications, Inc., at 184-10 Jamaica Ave., Jamaica, N. Y.

Member: Audit Bureau of Circulations

B. A. MACKINNON, President

H. K. FLY, Vice-President and Treasurer

Entered as Second-Class Matter at Jamaica, N. Y., under Act of March 3, 1879.

Executive and Editorial Offices, 381 Fourth Ave., New York, N. Y.

RADIO NEWS is published monthly, on the tenth day of each month preceding that of date. Entered as second-class matter at the postoffice, Jamaica, N. Y., under the act of March 3, 1879. Copyrighted 1929 by Experimenter Publications, Inc.; title

registered U. S. Patent Office. Subscription price \$2.50 a year; \$3.00 in Canada and foreign countries. Single copies, 25 cents each. The contents of RADIO NEWS are indexed in the Industrial Arts Index.



A MARVELOUS NEW IMPROVEMENT

IN RADIO TUBES

EVEREADY RAYTHEON TUBES GIVE A SUPERLATIVE DEGREE OF PERFORMANCE

INSTALL a set of new Eveready Raytheon Tubes in your radio receiver and note the unusually clear reception, greater volume and sensitivity. Quick heating and quick acting.

Behind all this is a revolutionary improvement in construction. The elements in each Eveready Raytheon Tube are firmly supported by *four strong pillars*, cross-anchored top and bottom. They are accurately spaced within one-thousandth of an inch when they are made. And so rigidly braced that the spacing cannot change with the knocks and jolts of shipment and handling.

In tubes of the 280 type and the 224 screen-grid type, which have heavier elements, this rugged Eveready Raytheon *4-Pillar construction* is of particular importance.

Only with Eveready Raytheon Tubes can you have this improved construction advantage. It is exclusive and patented. Eveready Raytheon Tubes come in every type, including tubes for television transmission and reception.

Eveready Raytheon Tubes are sold by dealers everywhere.

NATIONAL CARBON CO., INC.
New York, N. Y.

Unit of  and Carbon Corporation

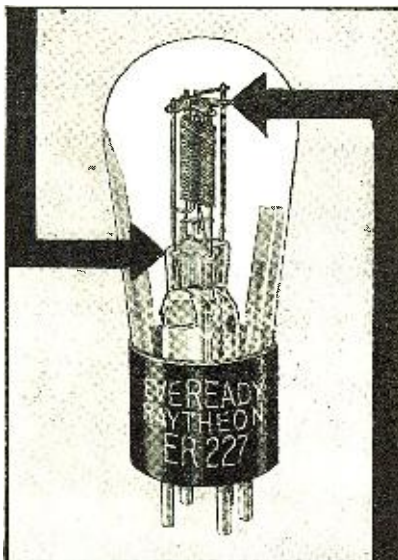

Showing the exclusive patented Eveready Raytheon 4-Pillar construction. Note the sturdy four-cornered glass stem through which the four heavy wire supports pass, and the rigid mica sheet at the top.



Eveready Raytheon ER 224 Screen Grid Tube. The 4-Pillar construction permanently holds the four heavy elements of this super-sensitive tube in the perfect relation which assures laboratory performance.



Radio's Tomorrow

A Glimpse Into the Future of the Communication and Entertainment Phases of Radio

IT is neither wise nor possible to make definite predictions as to what the science of radio holds for the future. And yet, due to organized research and engineering development, it becomes possible to see hints which enable us to speak of the probable achievements of a decade or two hence with much the same security that the artillery officer, knowing how his gun is aimed, can discuss the remote, invisible target which he has every assurance he will hit.

"For one thing, it appears to be only a question of time before the multitudinous problems of television must be solved and we may enjoy 'seeing' as well as 'hearing' the events of the world at our firesides. Another outstanding development of the next twenty years will undoubtedly be the availability of home talking movies.

"On the commercial side, we will assuredly witness a vast expansion in radio circuits and traffic volume. The steadily increasing exploitation of short waves, particularly the virgin field of ultra-short waves, must provide many more channels than are now at our disposal. It is quite possible that new methods of wave propagation and reception may provide additional channels even among existing wave bands, together with still greater freedom from static and natural interferences. With increased communication channels we may expect radiogram service to all parts of the world, even to the smallest countries and farthestmost corners not now covered because of the husbanding of valuable radio channels for the more important traffic. If the present trend in facsimile transmission and reception continues its steady progress, it is likely that the time-honored telegraph operator with his cumbersome dots and dashes will disappear by 1950. We may expect all radio messages to be handled in their original hand-written or typewritten form without recourse to the curt words of the present radiogram and without the delays and complications of the coding and decoding process of telegraphy. Photographs, drawings, fingerprints, commercial documents and other items will be flashed across the continents and oceans as a matter of hourly routine. It is even possible that newspapers may be reproduced in their entirety in any part of the world.

"Radio telephony, as a public or toll service, is also certain to thrive. Today, the American telephone subscriber may speak over the standard telephone instrument to a telephone subscriber in almost any European country via the respective telephone systems and the transoceanic telephone link. Experiments with short-wave radio telephone links may point the way to a vast increase in the number of available channels, in which event the service must ultimately extend to many

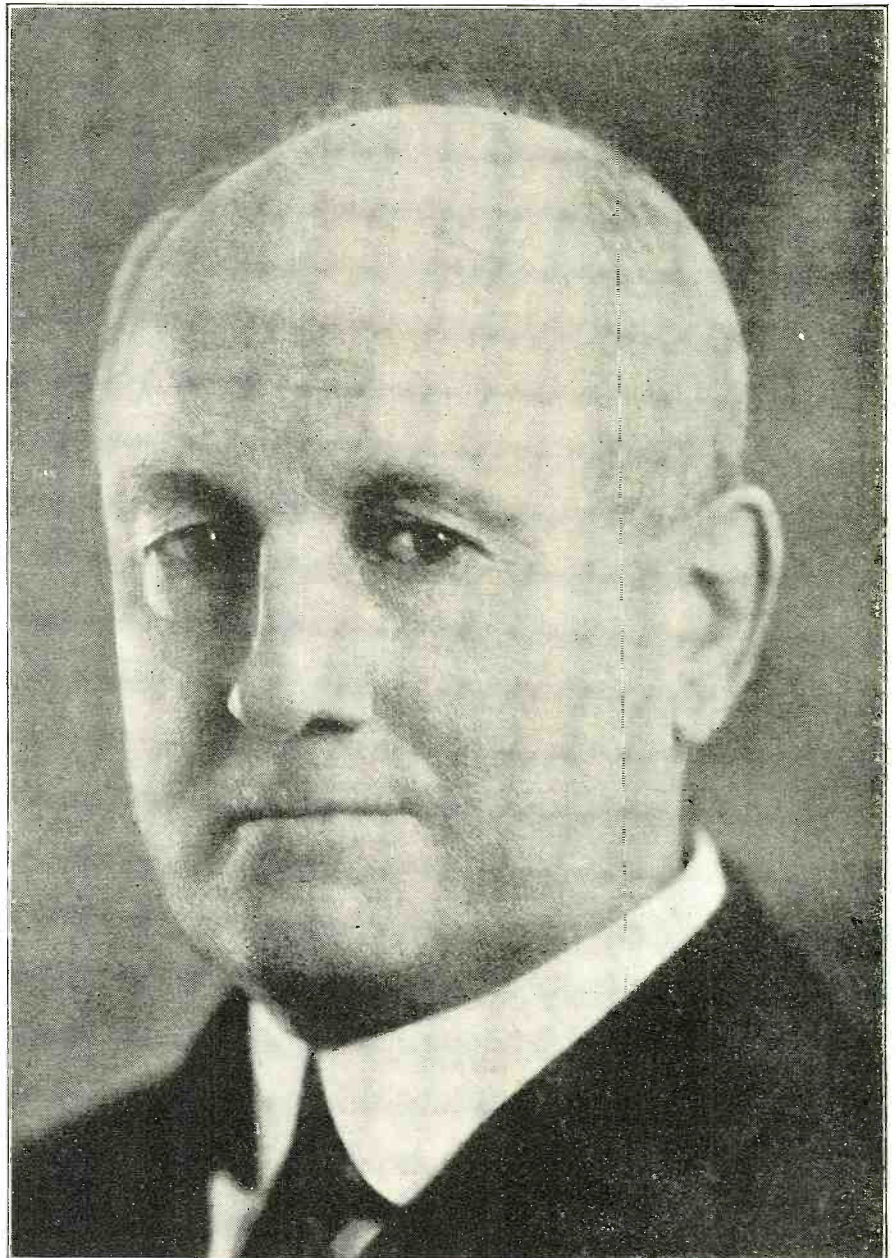

Courtesy of Radio Corporation of America

MAJOR GENERAL JAMES G. HARBORD *President, Radio Corporation of America*

Since shortly after the World War General Harbord has been at the head of the R. C. A. directing its many diversified activities. Only recently his organization has obtained an allocation of short-wave channels for inter-point communication within the United States. Besides actively engaging in the communication field which takes in marine and land radio, the R. C. A. is maintaining the operation of broadcasting stations for entertainment, the sale of radio receivers, tubes and reproducers and the development of practical television.

parts of the world and become relatively commonplace in business and social life.

"In the broadcasting field, international exchanges of programs seem to be assured within a short period of time.

Truly, one may look for advances in all branches of radio science, with progress continuing the even tenor of its way."—Maj. Gen. James G. Harbord, President, Radio Corporation of America.

Get the **RADIO** Job you want ... and fill it

in only **9** months

By means of this "Big-League" home-training
sponsored by the Radio Corporation of America

WHY struggle along on less than \$45 a week? Why wait years for success that can be yours in only 9 months?

As a result of a marvelous new kind of home-study training in Radio, hundreds of men are today leading straight for financial independence! Radio pays from \$2,000 to \$25,000 a year. The work is thrilling ... the hours are short. Vacations with pay ... opportunities for seeing the world ... adventure galore!

Prepare at Home with this Big Laboratory Outfit

Get the "How" as well as the "Why" of Radio—with this expert training! Only an hour or so a day—in spare time—is all you need! As part of your course, you receive absolutely free of extra charge—a magnificent outlay of apparatus. With this outfit you learn to build fine sets and solve the problems that bring big pay.

Training sponsored by Radio Corporation of America

Our graduates are in big demand everywhere. They enjoy greater success because they're posted right up-to-the-minute in *everything* in Radio. Radio's progress each year is measured by the accomplishment of the great engineers at work in the research laboratories of RCA. This great organization sets the standards for the industry, and stands back of every lesson in the course.

Money Back if Not Satisfied

The lessons prepare you for success in all phases of Radio—manufacturing, servicing, selling, ship and shore broadcasting, Television and Photoradiograms. A signed agreement backed by RCA assures you of complete satisfaction upon completion of the training—or your money will be promptly refunded.

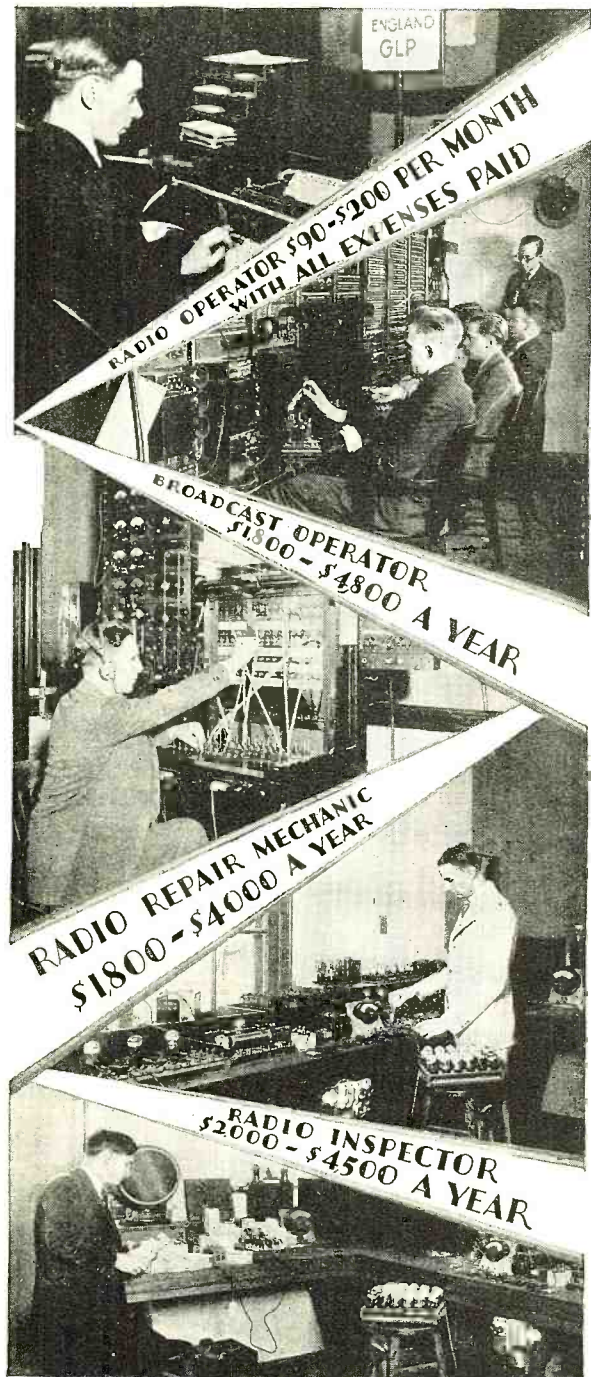

Read This Thrilling Free Book

It gives you the real "dope" about Radio and describes in detail the famous training that has enabled us to place thousands of our students in fine positions, usually from 3 to 10 days after graduation. It may mean the turning point in your life. It tells in 50 fascinating pages and photos all about Radio's brilliant opportunities for adventure and success. Mail the coupon now—the book is absolutely free!

Radio Institute of America, Dept. Ex-8
326 Broadway, New York



Radio Institute of America
Dept. Ex-8
326 Broadway, New York, N. Y.

Gentlemen: Please send me your big FREE 50-page book which tells about the brilliant opportunities in Radio and about your famous laboratory-method of guaranteed radio instruction at home.

Name.....

Address.....

Editorial

Coöperative Competition

"It seems to us that there is a marked similarity between the patent situation in the radio business and that which existed in the automobile industry until an agreement resulting in "coöperative competition" was reached. It does seem that a study of the agreements made by the automobile companies might result in a working plan that will save millions of dollars, not only for those now vitally interested—the manufacturers—but also for those who ultimately pay the piper—the users of radio apparatus."

—Arthur H. Lynch, in *Radio Broadcast*, April, 1923.

THE radio industry has taken a giant step forward.

The Radio Manufacturers' Association has just completed in Chicago its fifth annual convention, at which a great many things were discussed and a variety of solutions for different problems were brought forth. Simultaneously, there were held in Chicago conventions of the Federated Radio Trades Association and of the Musical Industries Chamber of Commerce.

Radio broadcast entertainment is, to an increasingly great extent, of the same essence as is the fundamental type of amusement which provides a continually growing business for the music trades. The joint conventions and trade shows, therefore, indicate a realization by the farsighted interests in the radio and music trades that in the final analysis they must cater to the same public, and that they have much the same problems to solve and the same goals to gain.

The "big news" of the convention of the Radio Manufacturers' Association did not break until the last few minutes of the last day of the convention.

The news was in the nature of a report of one of the committees whereby it was suggested that the manufacturers pool their patents, in much the same fashion as has been done in the automobile industry, through the Automobile Chamber of Commerce. The proposal met with the very hearty response of nearly every delegate to the convention. A definite plan of action has been arranged and it will be presented to the membership for their final vote within a reasonable time.

This is indeed a step in the right direction and one of which the Radio Manufacturers' Association may

well be proud. It seems, in essence, that much of the time and the money and the worry which patent litigation always carries in its wake may be conserved. It means that the brains which would be devoted to the winning of a costly defeat or an even more costly victory may be devoted to entirely constructive effort. The saving in dollars would be hard to compute and the saving in good will even harder.

It is with considerable gratification that the author of this editorial calls to the attention of the readers of this publication the fact that the first suggestion for the formation of a patent pool, similar to the Automobile Chamber of Commerce, was made by him, in the April, 1923, number of *Radio Broadcast Magazine*, of which he was then the editor.

In mentioning that fact, it is not with any thought of claiming paternity of a good idea. On the contrary, the idea itself is so constructive and so far-reaching as to overshadow the mere matter of parentage. But the same spirit of broad, constructive service which actuated the writer in his earlier connection with the radio industry is an indication of the much greater service which he trusts to render in the future, through the medium of a great group of magazines, covering a wide field of thought—namely, *Radio News*, *Science and Invention*, *Amazing Stories*, *Aero Mechanics*, *Your Body*, *Amazing Stories Quarterly*, *Screen Book*, *Plain Talk*, *Complete Novel*, *Complete Detective Novel*.

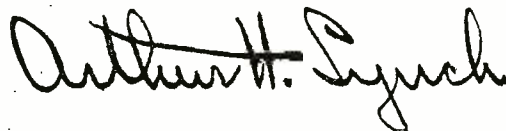

EDITORIAL DIRECTOR.

SM

Is There No Limit To What an S-M Receiver Will Do?

Australia to New York On Six Tubes

MORE and more astounding are the records of long-distance reception with Silver-Marshall screen-grid receivers. First the S-M 710 (Sargent-Rayment Seven) made itself famous as the one set which, in California, could be relied on to bring in Japanese broadcasting stations in any kind of favorable conditions—and often when conditions were otherwise. Later, reports began to be published of reception across the Pacific with the S-M 720 Screen-Grid Six—using only three screen-grid r.f. stages instead of four. Then, in March, came the publication of verified reception in New York City, from 2BL at Sydney, with the 710.

And now the Australia-to-New York record has been duplicated with the 720 Screen-Grid Six.

Not every one, perhaps, has the necessary skill to bring in stations from half way around the globe—but the hard-to-please listener, wherever he may be, soon finds that screen-grid tubes, combined with Silver-Marshall engineering, are the ultimate answer to every demand for superlative radio reception.

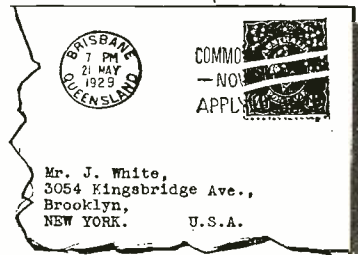
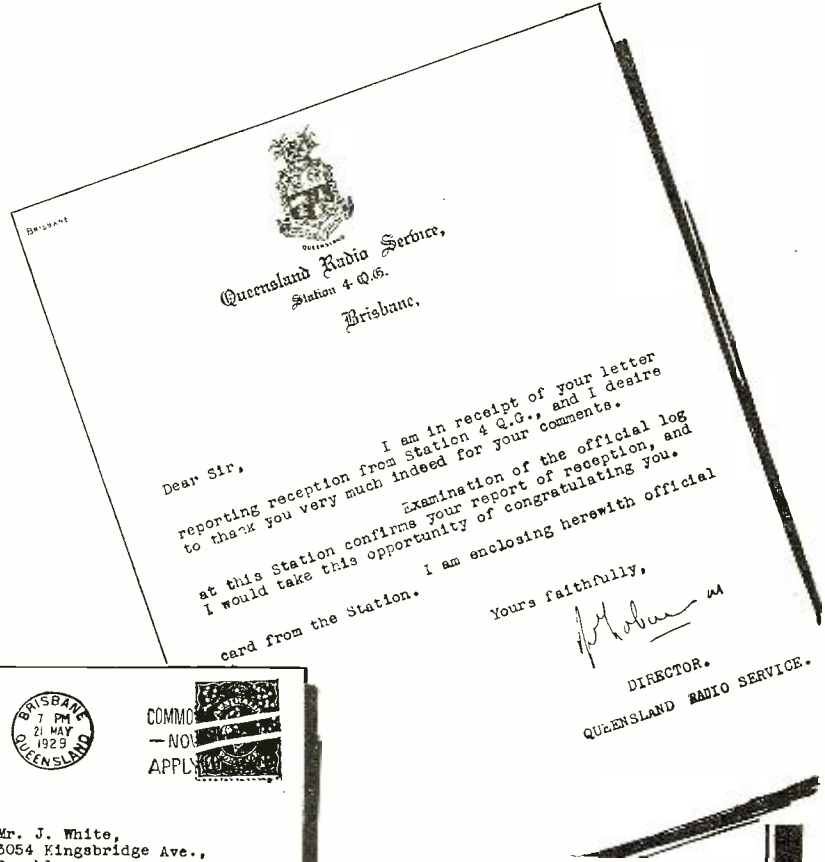

(Mr. White states this is his fourth reception from 4QG. Any one wishing to write him is requested to enclose a self-addressed envelope.)

Never-Equalled Tone Fidelity With S-M Audio Transformers

Equally startling records for faithful musical reproduction have been made this season by S-M Clough System audio transformers. These remarkable instruments, practically eliminating hysteretic distortion in all types of radio receivers, are now available in a full line of models. The tremendously popular 255 and 256 straight audio types cost only \$3.60 NET, and correspondingly low net prices have been set on all other types, including push-pull and output transformers and chokes.

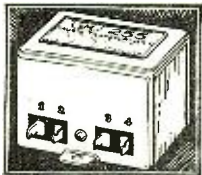

Setbuilders who have taken advantage of the unique franchises granted by Silver-Marshall, Inc., to Authorized S-M Service Stations have found that the building of radio sets and amplifiers from S-M standard parts is a highly profitable as well as an interesting business. If you build professionally, and have not investigated the Service Station proposition, ask about it now. And in any case, do not miss the monthly S-M "RADIO-BUILDER"; every issue contains big news for setbuilders. Use the coupon.

SILVER-MARSHALL, Inc.
6445 West 65th St., Chicago, U. S. A.

New List Prices (NET) on S-M Sets That Have Made History

S-M No.	Name	Scr.-Gr. Tubes	Wired Receiver	Component Parts Total
710	Sargent-Rayment Seven...	4	\$113.40*	\$78.84*
720	Screen-Grid Six.....	3	66.30*	44.79
720AC	Screen-Grid Six (A.C.)..	3	70.20*	47.07
730	"Round-the-World" Four.	1	42.90*	31.71*
731	"Round-the-World" Adapter.....	1	30.00*	22.86*
740	"Coast-to-Coast" Four....	1	48.60*	30.96
740AC	"Coast-to-Coast" 4 (A.C.)	1	50.70*	32.97

*Price includes metal shielding cabinet.

Silver-Marshall, Inc.
6445 W. 65th St., Chicago, U. S. A.
... Please send me, free, the new "NET-PRICE" S-M Catalog; also copy of the RADIOBUILDER.
For enclosed.....in stamps, send me the following:
... 50c Next 12 issues of The Radiobuilder
... \$1.00 Next 25 issues of The Radiobuilder
S-M DATA SHEETS as follows, at 2c each:
... No. 1. 670B, 670ABC Reservoir Power Units
... No. 2. 685 Public Address Unipac
... No. 3. 730, 731, 732 "Round-the-World" Short Wave Sets
... No. 4. 223, 225, 226, 256, 251 Audio Transformers
... No. 5. 720 Screen Grid Six Receiver
... No. 6. 740 "Coast-to-Coast" Screen Grid Four
... No. 7. 675ABC High-Voltage Power Supply and 676 Dynamic Speaker Amplifier
... No. 8. Sargent-Rayment Seven
... No. 9. 678PD Phonograph Amplifier
... No. 10. 720AC All-Electric Screen-Grid Six.
... No. 12. 669 Power Unit (for 720AC)

Name.....
Address.....

Radio News

Vol. 11

AUGUST, 1929

No. 2

Current Comment

LIFE grows more complex; a fact that impresses itself forcibly upon one who tries to interpret events before they happen. Last month, in these columns, we wrote of the plans for the *Graf Zeppelin's* flight to this country. When those words were written, it was still several days before her originally scheduled date of departure. The assumption was that, by the time they appeared in print, the flight would be a matter of history. But, as every newspaper reader knows, the weather intervened.

Once more, however, we evidence our faith in dirigibles, by mentioning that not only the *Graf Zeppelin*, but the British *R. 100* also, will probably visit these shores before the summer is over. In the case of the former, it is planned to carry out the original idea of having a regular communication schedule between the dirigible and the Lakehurst base.

As soon as radiophone contact can be established, on short waves, Mr. Frank E. Nicholson, who shipped as a passenger for that purpose, is to give a word-picture of life aboard, and to describe the *Graf Zeppelin's* progress toward Lakehurst. This is to be picked up and rebroadcast by stations of the Columbia network.

THE LEVIATHAN OF THE AIR, AS SHE APPEARED ON HER VISIT TO THE UNITED STATES IN 1928

Elsewhere in these pages we present an article on the dirigible's radio equipment, by Lieutenant Settle, who made the return voyage to Germany on her previous visit. We present,



FRANK E. NICHOLSON, THE GRAF ZEPPELIN'S "SPEAKING PASSENGER"

also, an article describing the short-wave set selected by the Columbia System for picking up Mr. Nicholson's signals.

The Weather, Once More

Wasn't it Mark Twain who said that everybody keeps talking about the weather, but nobody ever does anything about it? During the early Spring, one of the press associations announced that, all in all, some 700 human beings were scheduled to cross the Atlantic by the air route this Summer. So far, the weather prevented the flight of the fifty-odd on the *Graf Zeppelin*; it postponed several projected westward flights by plane; and it has delayed the American and French flyers who have for weeks been ready for the take-off from Old Orchard, Maine.

Advance information, as we mentioned last month, was to the effect that the *Yellow Bird*, piloted by Jean Assolant and Rene Lefevre, would carry radio equipment by means of which it would keep in constant touch with ship and shore. The *Green Flash*, which Roger Q. Williams and Capt. Lewis Yancey plan to pilot to Rome, has sacrificed radio equipment to save excess weight.

Both planes, at the present writing, are at Old Orchard, Me., awaiting favorable conditions. Needless to say, we are one with many thousands of others who wish them success. Yet we cannot help wondering whether radio equipment might not prove the deciding factor between their joining on the one hand the group represented by Lindbergh and Chamberlin, and,

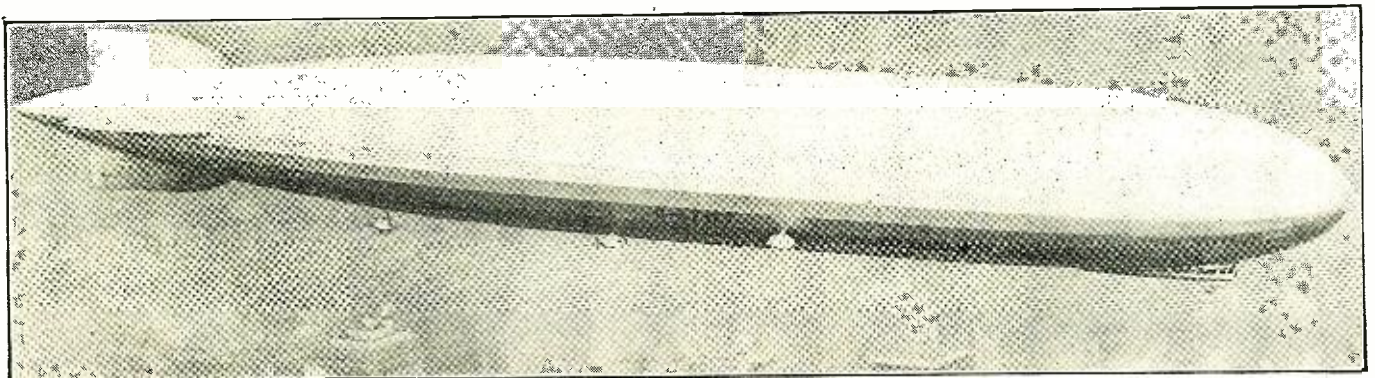

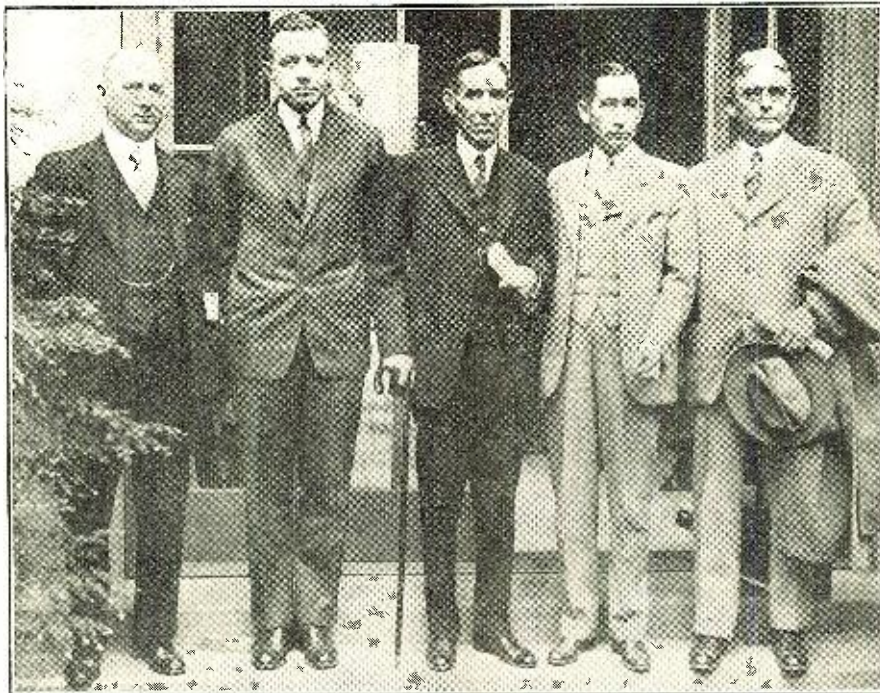

THE MEMBERS OF THE FEDERAL RADIO COMMISSION AT THE RECENT CONVENTION OF THE INSTITUTE OF RADIO ENGINEERS, IN WASHINGTON, D. C.

on the other, the intrepid Nungesser and Coli.

The Coast Guard plans to escort these planes to a point some 200 to 300 miles out; using a Loening amphibian, radio-equipped. It is the Coast Guard theory that most of the tragedies of transatlantic flying occurred comparatively close to our shores, and that the contemplated escort will provide a valuable factor of safety.

Speeding the Mail Service

With another bow to the weather, we note that the new owners of the *S. S. Leviathan* are actively experimenting with a means of speeding the transatlantic mail. Weather permitting, the first test of a device which is intended to permit a plane to swoop down over the liner and pick up mail sacks while both liner and plane are in motion, will have been made before these words are in print. Details of the device are too involved to go into, here, but the entire project is one of many which would be hopelessly fantastic without the active aid of radio. Only by means of radio, can the ship give its position, for the plane to set out for the meeting place. And, as the project develops, radio direction finding will undoubtedly play a major part.

For the present, plans contemplate saving a whole day in delivering European mail to New York. Behind these plans lie the ambitious dreams of later on being able to increase the distance from shore, and thereby further increase the time saved. It is

an intelligent linking together of the advantages of ships and the advantages of planes, with due regard to the disadvantages of each. With the railroads adopting a similar scheme, it remains only for America to become "air conscious."

The Incubator Baby

One of the saddest things that ever happened to the radio industry was that vastly over-publicized premature birth of television, some two years ago. After being led to believe that

some comparatively simple apparatus would enable the enthusiast to project a fair-sized "moyie"—received by radio—on the walls of his home, it is no wonder that the ill-defined, postage-stamp-size silhouette image actually received (when luck was good) soured many an enthusiast.

Nevertheless, careful "nursing" and "feeding" work wonders. Those cynics who point to the fact that at the recent Radio Manufacturers' show in Chicago, television was conspicuously absent, should not misinterpret the evidence. The infant is doing nicely; but it is not yet hardy enough to sit up in a perambulator and face the public.

The place to look for television, today, is not at a gathering of manufacturers, but at a gathering of engineers and scientists. The most recent such gathering was that of the annual convention of the Institute of Radio Engineers, in Washington last May. And there, television was very much in evidence.

Meanwhile, the Radio Corporation of America is broadcasting television daily from 7 to 9 P. M., D. S. T., over W2XBS, its experimental station, on a wave-band of from 142.8 to 149.9 meters. The pictures are 60 scanning lines high, and 72 elements wide, according to advices from Dr. A. N. Goldsmith, Vice President and Chief Broadcast Engineer. The Jenkins laboratories are continuing their experimental transmissions, also.

FACING THE LIGHTS AND SCANNING DISK OF THE R. C. A. TELEVISION BROADCASTING STATION, W2XBS

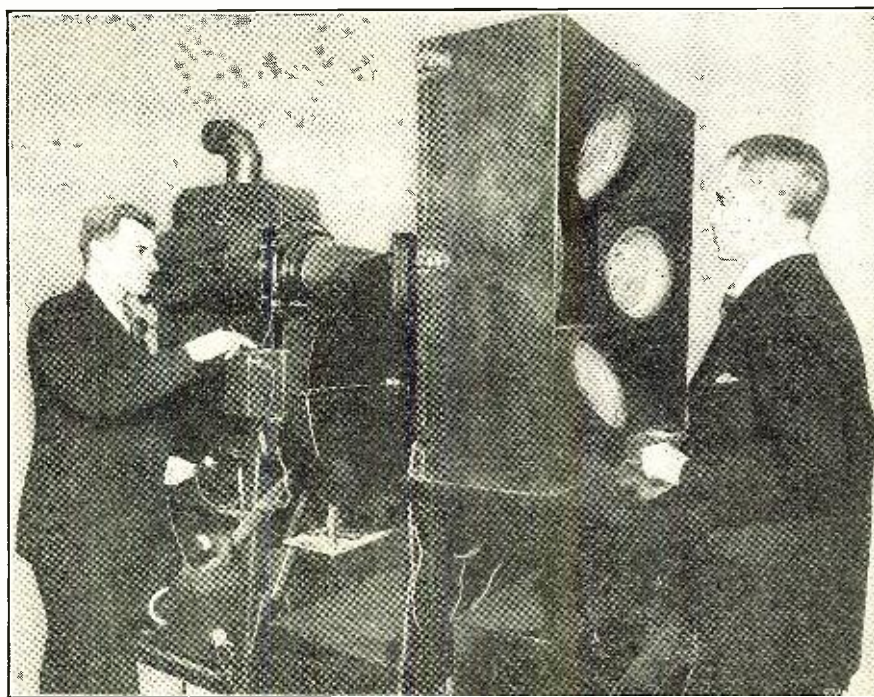

This subject is treated elsewhere in the present issue in far greater detail than space permits here.

Another form of television which was recently demonstrated, while limited in its application, is decidedly interesting. We often lose sight of the fact that radio waves and light waves are, like Judy O'Grady and the Colonel's lady, "sisters, under the skin." Dr. Paul A. Kober, television engineer of the United States Radio and Television Corporation, made use of that fact.

On the 11th floor of L. Bamberger's store (WOR) in Newark, he demonstrated the feasibility of transmitting motion pictures a distance of 100 feet; using ultra-violet light waves instead of radio waves as the transmitting medium. Although this system is limited to a distance of not more than 25 miles, and cannot penetrate physical obstructions, it is directional; a factor of importance for certain fields of development.

The apparatus, aside from the oscillator, is based upon the same principles as are used in radio television. As the number of radio channels available for television is decidedly limited, any method which relieves that situation is well worth while.

The Modern War Correspondent

During the recent war maneuvers between the "Red" and the "Blue"

A FACSIMILE OF THE FIRST COMMERCIAL PHOTORADIOGRAM SENT FROM SAN FRANCISCO TO LONDON

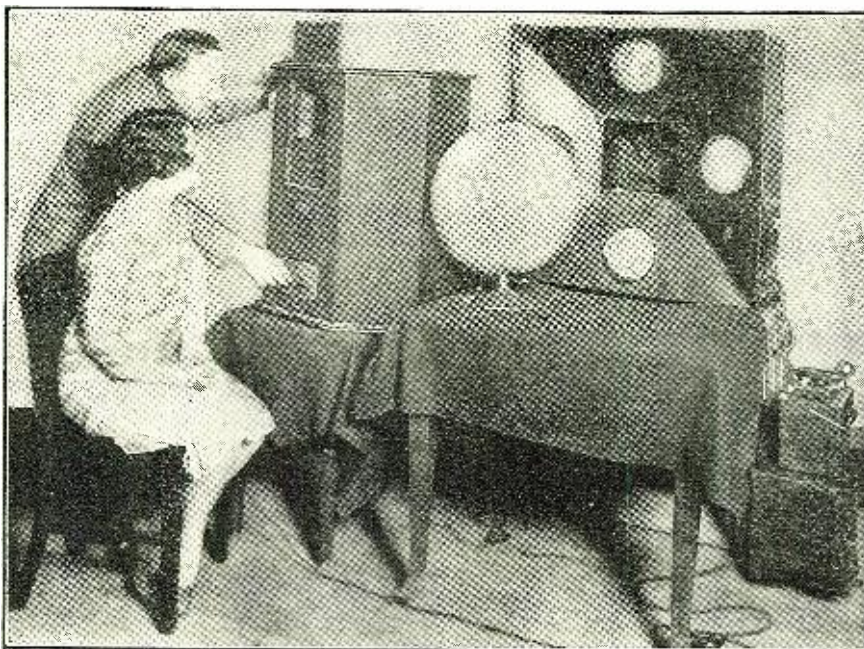
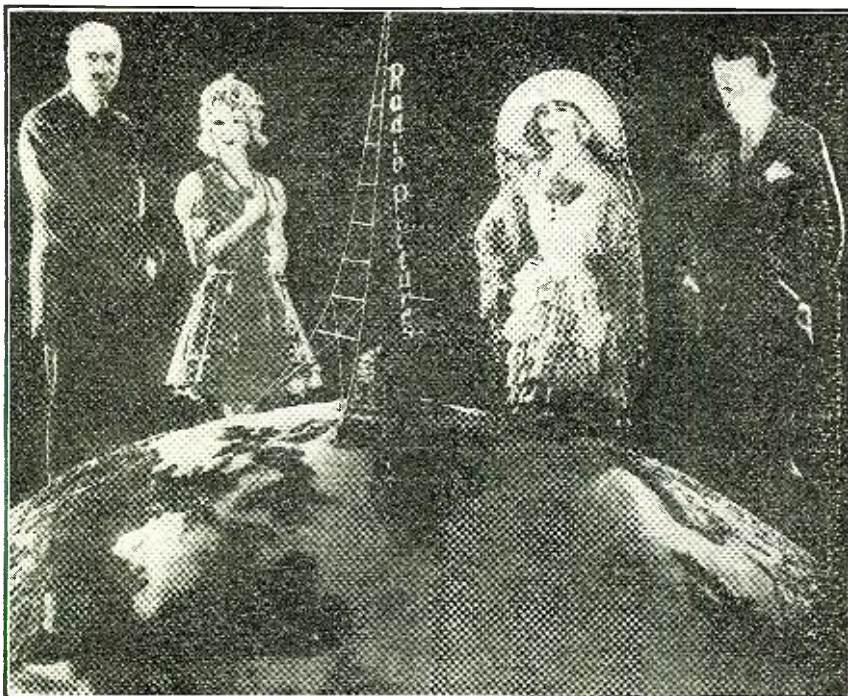

A DEMONSTRATION OF TELEVISION TRANSMISSION BY ULTRA-VIOLET AND VIOLET LIGHT RAYS

forces of the army, radio listeners were treated to a taste of aerial reporting. The re-fuelling and bombing demonstration, in which a plane theoretically bombed New York, encountered weather which interfered with the original plan to rebroadcast a running description from the air. In Cincinnati, however, as told at length elsewhere in this issue, the aerial war correspondent gave a good account of himself, in cooperation with station WLW of the Crosley Radio Corporation.

The sad part of it is that, in actual war-time, radio becomes a part of the national defense, and there is little likelihood that we will be allowed to attend battles in any capacity other than as performers.

Radio Versus Wire Service

In the latter part of May, the Chief Executives of New York City and San Francisco officially opened the first radio-telegraph circuit between those two cities. Extending also to Boston and Washington, the service links San Francisco for the first time directly with the larger cities of Europe and South America through all-radio channels.

The new circuit bridges the 3,000-mile transcontinental span without a relay, and makes use of an improved projector system. It is the first service of its kind and is said to be the forerunner of a proposed radio system which will link the important cities of this country, operating in direct competition with wire telegraph.

In the central operating offices at New York and San Francisco the radiograms are translated into perforations on a tape typewriter, passing through an automatic transmitter. Traveling with the speed of light the signals require one sixty-second of a second to complete the transcontinental journey. At the receiving end the message is automatically written on a moving tape by an ink recorder and typed by operators.

The circuit also will be employed for transmission of photographs.

Radio and Exploration

Commander Byrd seems to have set a fashion, in giving attention to radio communication facilities for his long sojourn in the Antarctic. Nowadays, hardly an expedition leaves for any of the remote corners of the earth, without first arranging for its radio communication.

Gifford Pinchot, who not very long ago set sail with his family on a scientific expedition which had been his cherished dream for years, is one example. And another, of perhaps more direct interest in the strictly radio field, has recently come to hand. Quoting from press dispatches:

"One of the most comprehensive programs of research of tropical and equatorial radio problems ever undertaken will be conducted by the All-American Lyric Malaysian expedition to Borneo, it is announced by Eugene R. Farny, president of the All-American Mohawk Corporation of Chicago, financing the expedition. At least one year will be spent in the field, Mr. Farny said. The party is due in Borneo early in June.

"When the task is completed, the expedition expects to have answers to many important radio problems, including why short waves may be just barely heard 200 miles from the point of origin, but come in in great strength 2,000 miles away; why radio waves, sent from Borneo to the United States, are often lost when they hit the north polar cap; fading of radio waves in the tropics and other related problems.

"In addition to radio problems, the expedition will seek Anthropological data among the Siang Dyaks and mysterious Punan tribesmen of Dutch Borneo. Anthropologists know little about the culture of the Punans, a very primitive people who live in the dense jungles along the upper Barito river.

"Theodore Seelmann, former newspaper man and world traveler of note, is leader of the expedition. Harry W. Wells, radio engineer, will direct the radio section of the party, and John H. Provinse, anthropologist, and Seelmann will spend their time with the natives.

"Wells will establish a 50-watt short wave portable transmitter and receiver at Poeroek-Tjahoe, 250 miles up the Barito river, the last outpost of civilization, and the main base of the expedition. Seelmann and Provinse will live in the native kampongs, carrying with them transmitters and re-

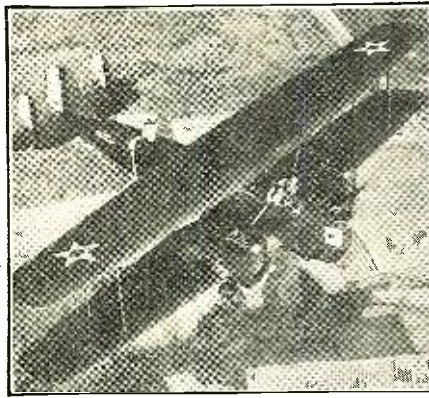

ARMY BOMBING PLANE USED IN CONNECTION WITH RADIO EXPERIMENTS IN THE RECENT WAR GAME

ceivers to enable them to keep in constant touch with Wells. Wells, in turn, will be able to communicate with them and also with far away places, including the United States.

"Mr. Farny made public a communication just received from Wells, in which the radio research work is outlined. It follows in part:

1. Fading: Daily observations and measurements on signal strength of certain commercial and amateur stations over a wide frequency range will be taken at regular intervals for a period of a year. Barometric pressure, atmospheric conditions, temperature, etc., are to be recorded. Upon returning to the United States, data concerning the local conditions at the observed stations and also along the great circle route traveled by the radio waves will be compiled in an effort to establish some definite connection between efficiency of high frequency radio transmission to distant points and weather conditions along the route.

2. Skip Distance: On short waves it may be possible for a transmitting station to be heard, say, 200 miles away, but at 2,000 miles the signals may be very strong. The present explanation of this phenomena is that the radio waves are radiated in all directions from the antenna but are reflected back to earth from the Heaviside layer. There are other locations to which no waves are reflected, and

the distance from these points to the transmitter is termed the skip distance.

3. Polar Cap: Radio waves travel from one point to another on the earth's surface by the shortest distance. This distance is the arc of a great circle through these points. It so happens that the arc of the great circle between Borneo and the East Coast of the United States passes over the North Polar Cap.

In winter time the Heaviside layer is so affected by this cold Polar Cap that the radio impulses are not received on the other side. However, in the summertime no particular difficulty is noted. The expedition expects to establish contact

MAP OF THE TERRITORY IN WHICH RADIO RECEPTION EXPERIMENTS ARE TO BE CARRIED OUT

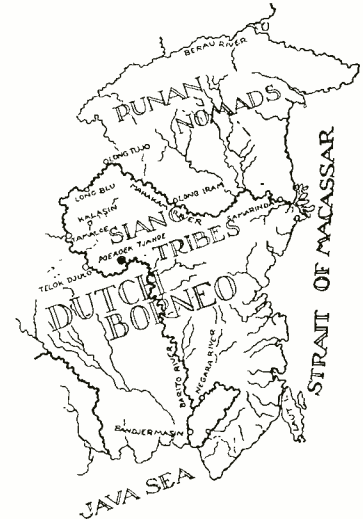

with stations on the East Coast, including the Naval Research Laboratories at Bellevue, South Carolina, and run a series of tests in an effort to obtain some more definite data concerning this peculiarity.

4. Tropical Conditions in General: A thorough study of all the available information on tropical radio transmission and reception has been made and certain precautions have been taken with the equipment, while still more will probably be effected in the field.

W. Thomson Lees

Managing Editor

"The S-W Four"

A New Departure in Short-Wave Receiver Construction

By SAMUEL EGERT

THE short-wave receiver described in the accompanying article is of interest on several counts. Not the least of these is the fact that this receiver has been selected for an important bit of work in connection with the *Graf Zeppelin's* visit to this country.

The Columbia Broadcasting System announced, some time ago, its plan to have Frank E. Nicholson, aboard the dirigible, send daily accounts of progress and of life on board; these to be rebroadcast through stations of the Columbia network. It is a part of this plan, to rebroadcast Mr. Nicholson's voice just as soon as the *Graf Zeppelin* is near enough to permit voice reception on short waves.

Paul Green, technical director of the Columbia System, is responsible for arranging to keep in touch with the dirigible, and after careful examination he selected for that purpose the set here described. Aside from the merit implied by its selection for this important work, the S-W Four will appeal to the radio experimenter both because of the efficiency of the circuit employed, and because of the clean-cut engineering evidenced in the planning of the three compact units comprising the radio frequency, detector, and audio frequency sections.

THERE'S a thrill waiting for you in the lower wavelength bands, where great distances are spanned by comparatively small sets consisting of two, three or four tubes.

Even the wide imagination of the authors of the Arabian Nights could not conceive of listening to their fellow men half-way around the world.

The amazing properties of short waves stagger the imagination. Think of it . . . cosily ensconced in your favorite chair, the chimes of Big Ben in London, the far-off countries of Holland, New Zealand, Spain, are at your mercy. Listening to these stirs the imagination to the realization of another wonder accomplished by man. There's more to be done, but at present the field is wide open for the man who can appreciate the tremendous scope of this hobby and wants to look just a little below the surface.

In last month's RADIO NEWS Mr. Curtis Glenn described quite vividly what he listened to in the short span of twenty-four hours. Yet, even so, the surface has just been scratched. Given a good, efficient receiver, the possibilities of listening to far-off signals, signals from the ends of the earth—yes, signals that virtually travel 'round the earth—are boundless.

It is with the idea in mind of providing such an efficient receiver that the one described here was designed.

Many Good Features

The S-W Four is one of the most modern short-wave receivers that can

be built today. Its neatness, its isolation of each individual stage, its ease of tuning, coupled with the high grade of material employed throughout, make it a set far surpassing others in quality and volume of tone; it possesses a sensitiveness which enables it to pick up foreign stations as if they were in your back yard. Short-wave station 5SW, England, comes in on the loudspeaker and can usually be gotten whenever operating, even though static conditions may be quite bad. Holland can be heard on the phones quite loud and clear and can be heard on the

loud speaker on a clear night. With this receiver California, KDKA, WGY are considered locals and can be tuned in on the loudspeaker. Besides, there are at present about six hundred short-wave stations in operation located in every part of the world. Given a good night for reception, as sensitive a set as the S-W Four and a fairly decent location—well, you can see for yourself—the possibilities are unlimited. One thing is certain, the S-W Four presents to every man something worth while in which to lose himself after a hard day's work is done. Here is really a new and better way to get back all the enjoyment you derived from your broadcast band experience, with a double redemption.

Use of Shielding a Major Factor

The distinct superiority of the S-W Four is the shielding. Each stage is individually shielded, enabling the r.f. amplifier, detector and audio amplifier stages to work with absolutely no intercoupling. Their use counteracts flux lines between stages, enabling the set as a whole to function with the highest degree of efficiency. This outstanding feature is **immediately** recognized when you tune the set. A certain amount of pep can be recognized which places it head and shoulders above others which do not use complete individual shielding. The shielding arrangement of the coils is both novel and effective. The small metal caps protruding from the tops of the units need only be removed to replace the plug-in coils. Coils can be replaced in a second's notice without in any way hampering the operation of the receiver. When you replace a coil, you will notice that a grooved socket is furnished, en-

HERE'S THE S-W FOUR IN RADIO NEWS LABORATORY

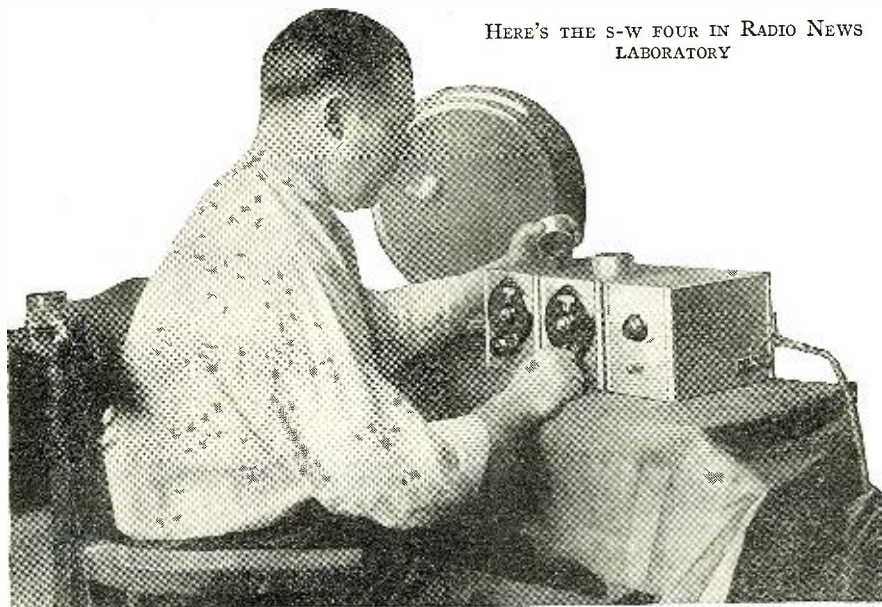

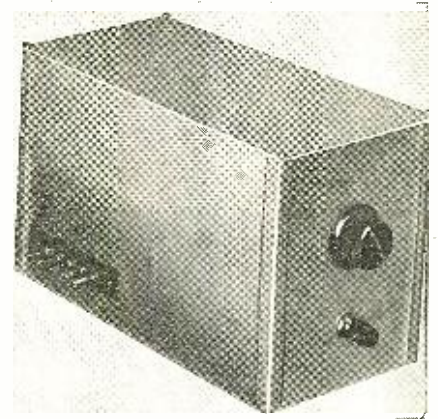
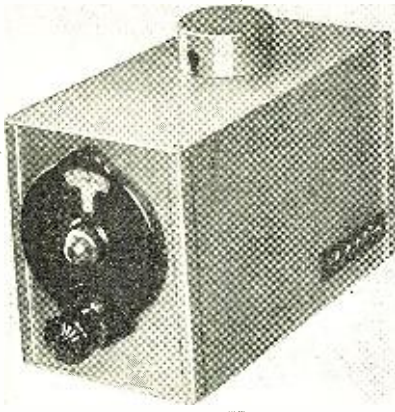

THREE INDIVIDUAL UNITS IN SEPARATE SHIELDED COMPARTMENTS CONSTITUTE THE COMPLETED S-W FOUR. HERE ARE SHOWN, FROM LEFT TO RIGHT, THE TUNED ANTENNA R.F. STAGE, THE DETECTOR STAGE AND TWO-STAGE A.F. CHANNEL

abling you to merely turn the pins of the coil around in the groove until they automatically fall into place in their respective positions in the coil socket. This avoids a good deal of delay and affords a convenience that is immediately appreciated. The circuits in the shielded units are connected together by means of small plugs and jacks mounted on insulated bakelite strips. The use of this method enables you to obtain a positive connection from unit to unit without in any way hampering the quality of the shielding. When plugging the cans together, you will notice that there are four contact plugs and jacks between the r.f. and detector units and five between the detector and audio units. This avoids any possible error of the proper placing of the r.f. and detector units. In spite of all these shielding re-

quirements, the set has a fine appearance and would always attract rather than detract attention to itself. You will notice that the units are separated by a space of about one-fourth of an inch. This is an absolute necessity. We have found from experience that the potential (or voltage) at the front of the detector or r.f. units is different from the potential (or voltage) at the rear of these units. These potentials are induced by the flux lines of the two coils. This potential (or voltage) difference is so small that only very accu-

rate instruments could be employed to measure their differences; however, these potentials are very noticeable in the phones or in the speaker when the units come in contact with each other. A cracking noise is heard and it is due to the shorting of these small potential (or voltage) differences. Therefore, to avoid this disturbance the units have been separated one-fourth of an inch. This seemingly small feature adds a tremendous benefit to quietness of operation and is in reality a blessing in disguise.

THE GENERAL LAYOUT OF A MAJORITY OF THE PARTS IN THE THREE UNITS IS CLEARLY INDICATED HERE. THOSE COMPONENTS WHICH ARE MOUNTED ON THE UNDERSIDE OF THE SUB-BASES ARE SHOWN IN POSITION ON PAGE 111

TO GAIN A CLEAR IDEA OF THE INDIVIDUAL CIRCUITS OF EACH OF THE SHIELDED STAGES, IT IS ONLY NECESSARY TO COMPARE THE COMPLETE CIRCUIT DIAGRAM, SHOWN HERE, WITH THE PHOTOGRAPH AT THE TOP OF THIS PAGE

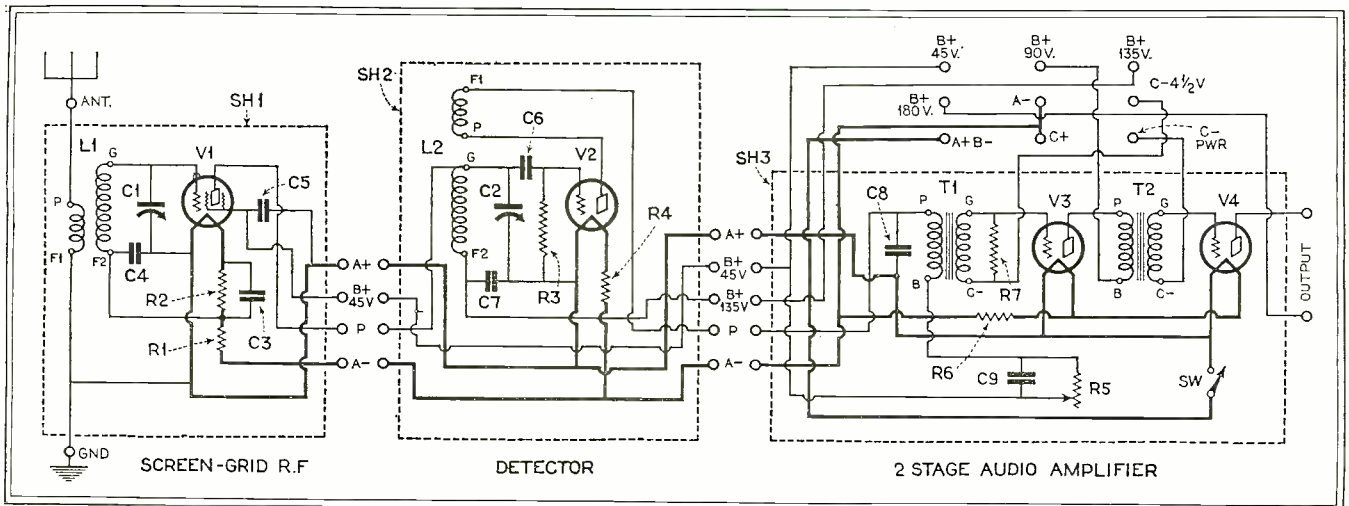
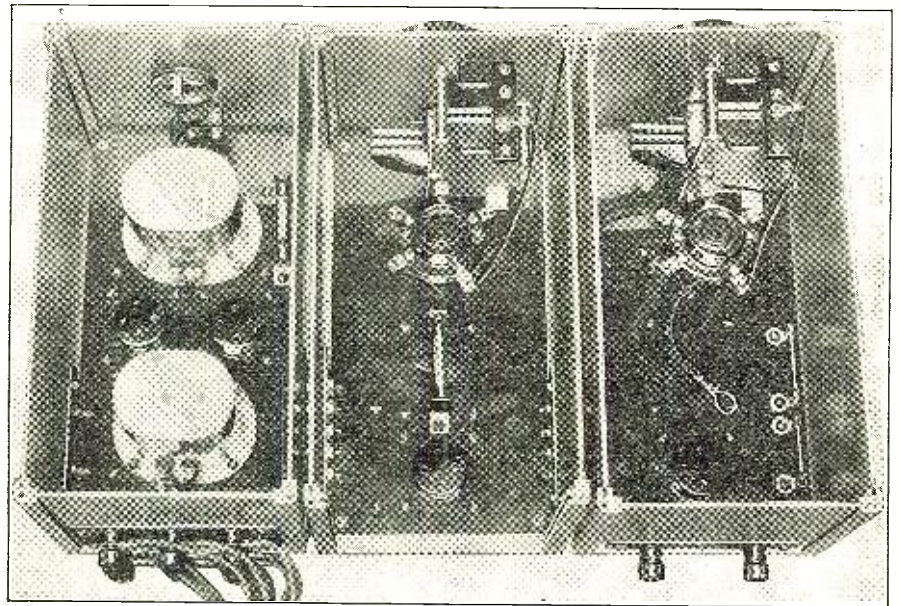

A PARTS LAYOUT AND CIRCUIT WIRING DIAGRAM OF THE S-W FOUR IS GIVEN HERE. THOSE WIRES WHICH PASS THROUGH HOLES IN THE SUB-BASE ARE NUMBERED FOR IDENTIFICATION AND SHOULD BE FOLLOWED THROUGH BY REFERRING TO THE CIRCUIT WIRING SHOWN ON THE FOLLOWING PAGE

- TERMINAL KEY**
- ① B+45 V.
 - ② B+90 V.
 - ③ B+135 V.
 - ④ B+180 V.
 - ⑤ A-
 - ⑥ C-4½ V.
 - ⑦ A+B-/-
 - ⑧ C+
 - ⑨ C-PWR

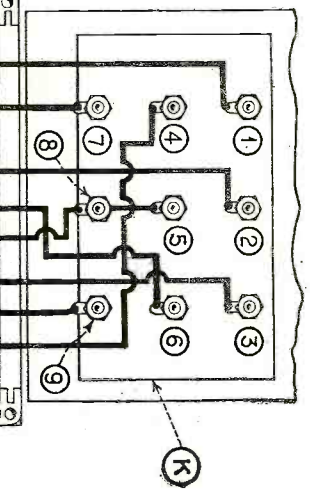
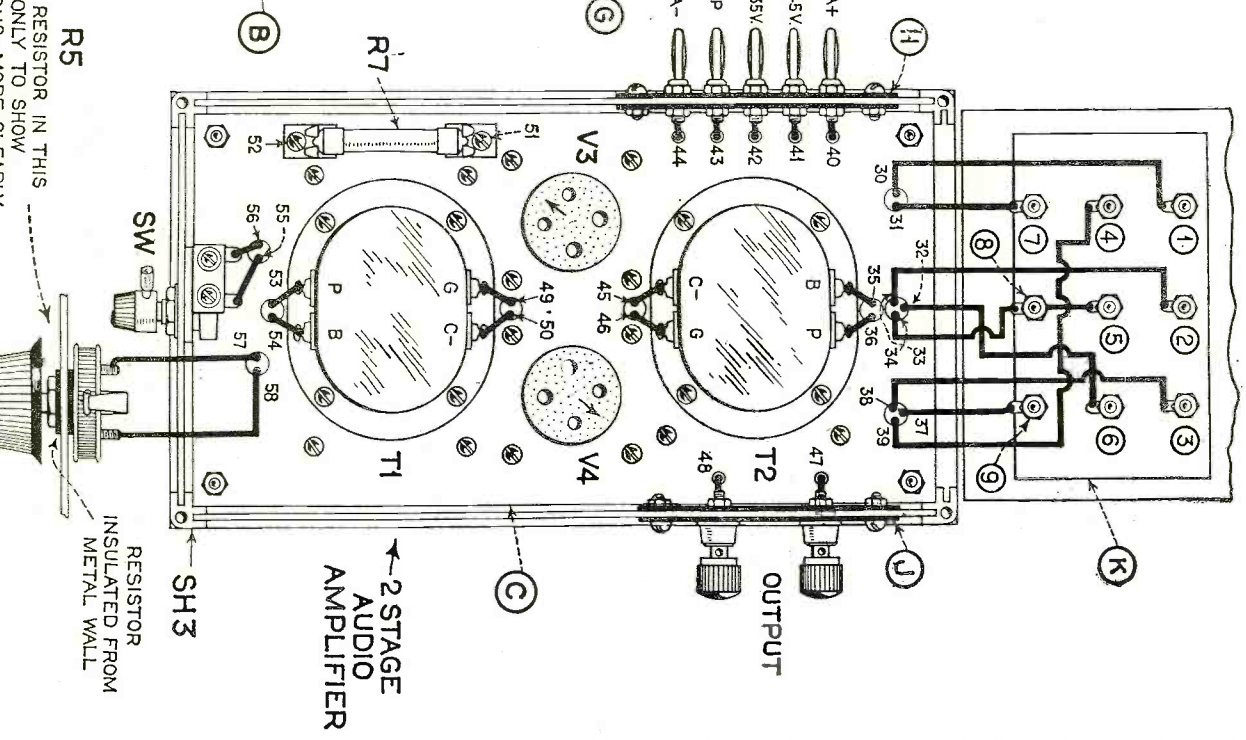
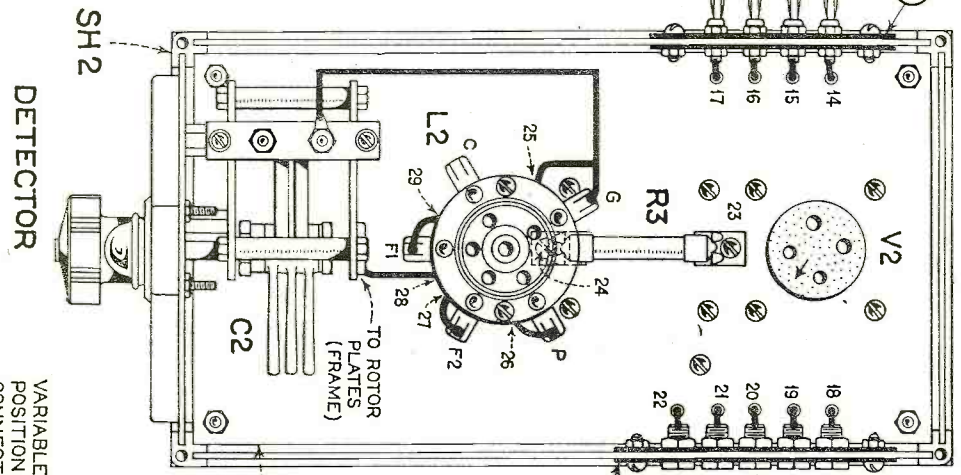
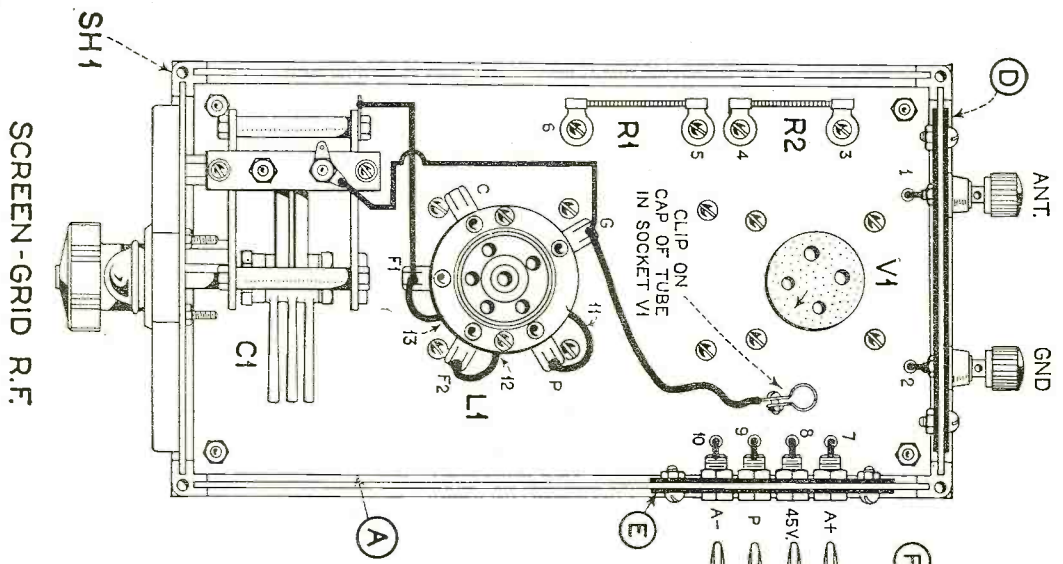

SCREEN-GRID R.F.

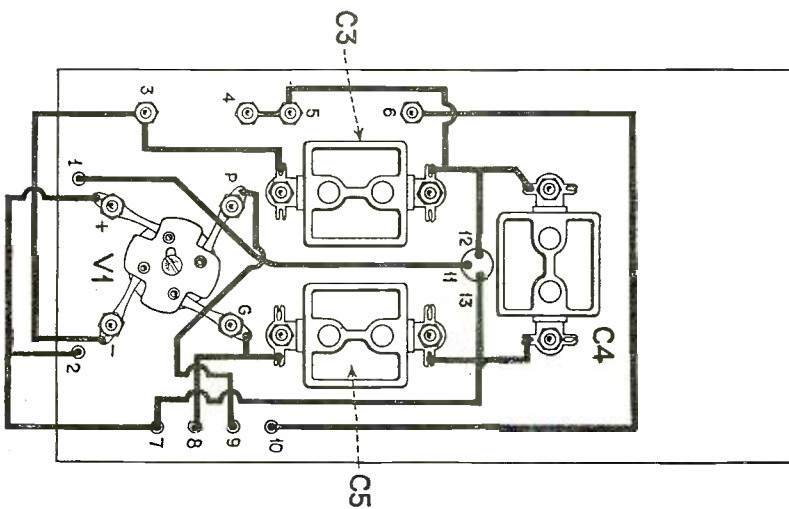

DETECTOR

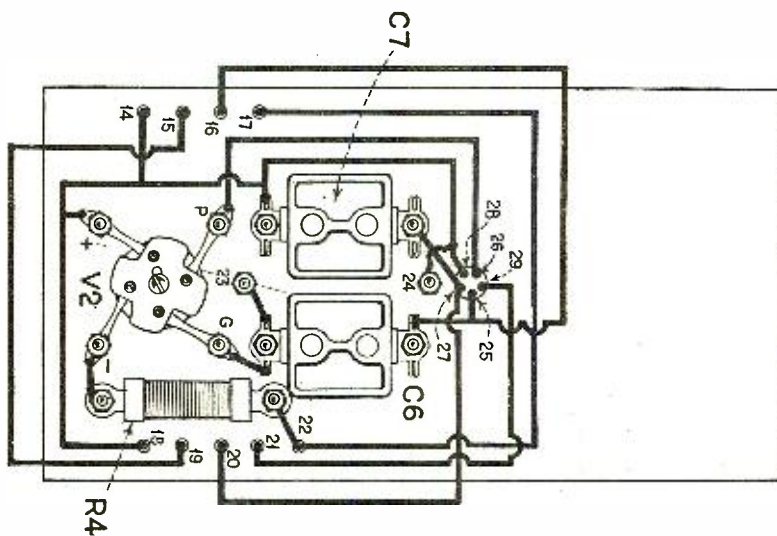

2 STAGE
AUDIO AMPLIFIER

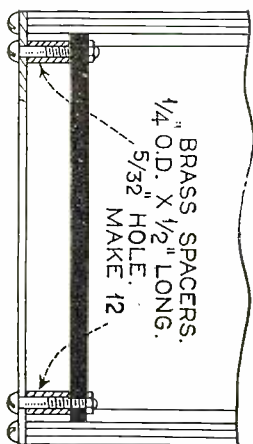
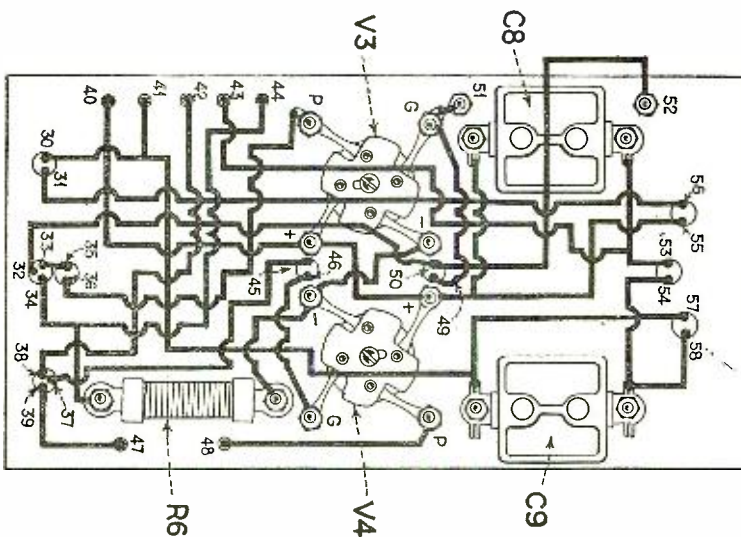

THIS VIEW SHOWS HOW BASES
A B C ARE MOUNTED IN SHIELD BOXES.

BESIDES SHOWING THE DETAILS OF
WIRING ON THE UNDER SIDE OF THE SUB-
BASE, TO THE LEFT ARE SHOWN THE
DETAILS FOR RAISING THE SUB-BASE FROM
THE BOTTOM OF THE SHIELD CAN SO
THAT SUCH PARTS AS FIXED CONDENSERS,
RESISTORS AND TUBE BASES MAY BE
LOCATED

THIS VIEW SHOWS HOW
SOCKETS FOR COILS
L1 & L2 ARE MOUNTED.

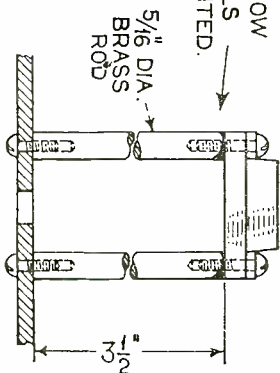

Due Consideration Given Parts Layout

Proper low-wave reception is difficult to attain. Every small item of construction must be taken into account. If only one of these items is inadvertently passed over, the efficiency of a short-wave receiver is reduced markedly. Therefore, it was important that we should not overlook the selection of the parts, the placement of the parts, the method of wiring and the quality of each part when adapted to our needs. It was only in this manner that we finally succeeded in developing the easily operated, easily constructed and highly efficient receiver that is described here.

Great care was taken in determining the proper position for each part. Grid leads are as short as possible. This is a primary requisite in a set of this type, for in long grid leads a great deal of energy can be lost due to the characteristic of high frequencies to form counteracting flux lines to the flux lines of the regular coil. Every connection in the set is made on the shortest path possible. Bending wires which carry high frequencies is also a poor policy, for here again we have a high rate of signal dissipation.

Only the best of apparatus is used in the receiver. The taper plate condensers used offer a straight-line tuning effect. That is to say as the dials are turned from minimum to maximum the wavelength rises in direct proportion to the

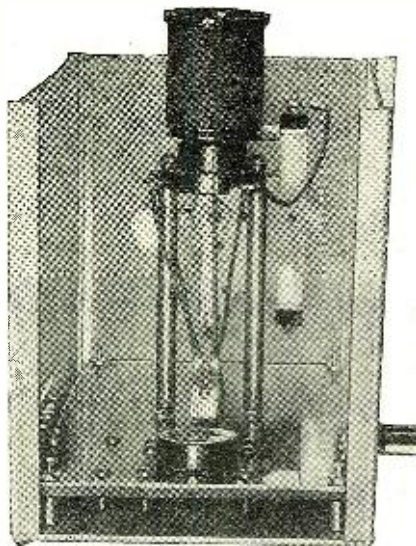

IN THIS CLOSE-UP VIEW OF ONE OF THE TUNED STAGES IS SHOWN THE DETAILS FOR MOUNTING THE COIL SOCKET ON SPACER RODS SO AS TO SUPPORT THE PLUG-IN COIL

numbers on the dial. The condenser is solidly constructed. One needs only to examine it closely to appreciate its qualities. Its taper plates give you the advantage of a small circle circumscribed by the plates and help towards reducing the size of the shielded units. Straight-line frequency condensers of the logarithmic type of plate would be so large as

to hit against the side walls of the unit. The sockets employed enable the user to enjoy a short-wave set that is not microphonic. These sockets also afford a strong and reliable contact from socket to tube. It is not necessary to explain the value of this advantage, for every sure contact on a receiver of this type is nothing more than another closed link in the chain of sensible design features.

IF THE CONSTRUCTOR HOPES TO ACCOMPLISH THE SAME RESULTS IN THE OPERATION OF THE S-W FOUR AS OBTAINED BY THE AUTHOR, IT IS A FOREGONE CONCLUSION THAT THE WELL-PLANNED DISTRIBUTION OF THE PARTS SHOULD BE STRICTLY ADHERED TO. THE SEVERAL DRILLING LAYOUTS GIVEN BELOW WILL AID MATERIALLY IN THE ACTUAL CONSTRUCTION. A, B AND C SHOW THE LOCATION OF HOLES OF THE ANTENNA STAGE, DETECTOR STAGE AND TWO-STAGE AUDIO AMPLIFIER SUB-BASES RESPECTIVELY. IN THE LOWER PART OF THE DRAWING IS SHOWN THE DRILLING NECESSARY FOR THE BAKELITE PIECES WHICH SUPPORT THE BINDING POSTS AND PIN-JACKS, ETC. FROM LEFT TO RIGHT THE FIRST TWO ARE MOUNTED IN THE FIRST OR R.F. CAN AND ARE THE ANTENNA-GROUND STRIP, D, AND FOUR-PRONG PIN-JACK STRIP, E; THEN THE LEFT AND RIGHT PIN-JACK STRIPS F AND G, OF THE DETECTOR STAGE; THEN THE PIN-JACK STRIP, H, AND LOUD SPEAKER BINDING POST STRIP, J, OF THE TWO-STAGE AUDIO UNIT; FINALLY THE BINDING-POST STRIP FOR THE BATTERY TERMINALS

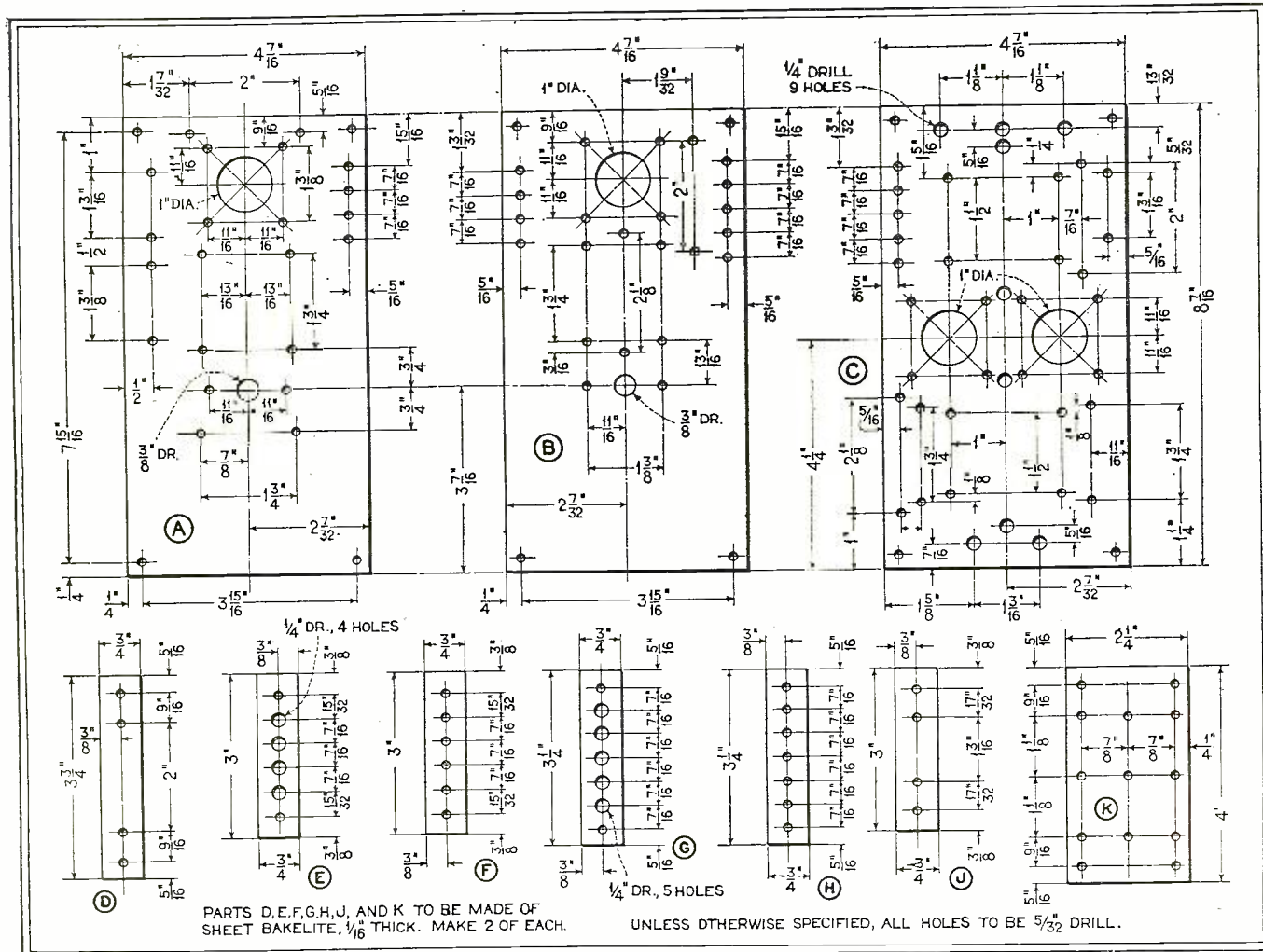

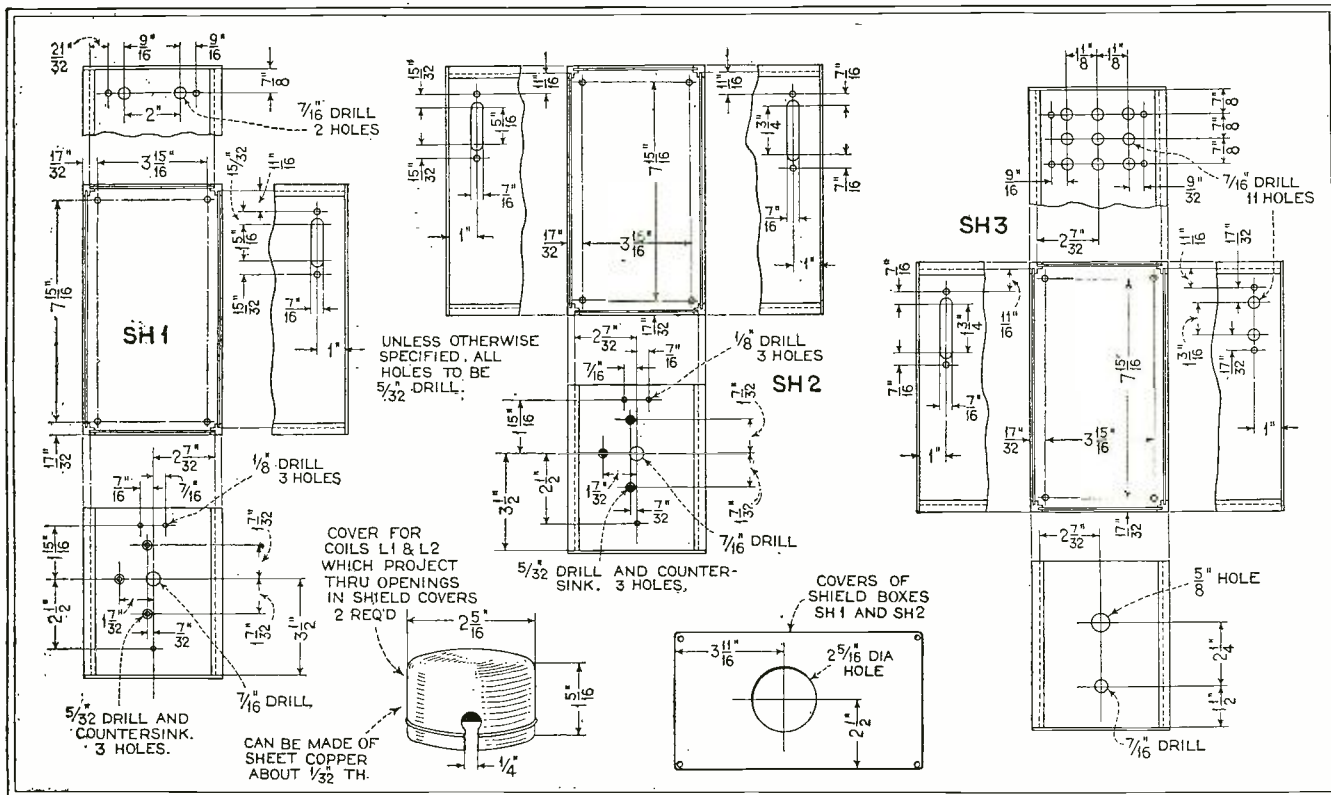

DRILLING DIRECTIONS FOR EACH OF THE SHIELDED UNITS ARE GIVEN HERE; ALSO NOTE THAT DIMENSIONS AND PLACEMENT OF THE HOLES IN THE TOP OF THE SHIELD CANS, ALLOWING ACCESS TO THE COILS, ARE SHOWN

Fixed filament resistors are used for every tube. In this manner, we are able to control the complete filament system by means of a single switch. This method of filament adjustment is a distinct advantage in a short-wave set. It enables each tube to work at its highest point of filament efficiency at all times. Rheostats employed on short-wave sets have always given trouble. Scraping and scratching noises in the phones disturb the operator when the rheostat is turned and the level of sensitiveness of a receiver is often brought far below normal due to the lack of filament voltage impressed upon the tube.

Another feature which is highly important in the operation of the set is its application of by-pass condensers. Applied in the proper fashion, the latter tend to reduce the noises that might be produced by the movement of various parts. Every possible means of reducing these disturbances have been taken into account. Highly efficient fixed condensers enabled us to accomplish this desired effect. Five .006 mfd. condensers are used to by-pass the set properly. A .0001 mfd. condenser is used in the detector grid circuit and a .002 mfd. condenser is used across the first audio transformer primary to enable the detector to oscillate properly.

In the operation of the regeneration control, the by-pass condenser across the control helps considerably toward quietness of operation. The noise that is heard in an ordinary receiver, due to this control, is here diminished and the ease of its operation is a pleasure rather than a hindrance toward attaining the highest degree of sensitiveness of the

receiver. The regeneration control is a 100,000 ohm variable resistance. This control fits ideally into its important position. Its smoothness of operation and its ability to control the amount of regeneration necessary offers a distinct advantage to the operator. He will find that when operating this control, at times, it will be hard for him to distinguish when the set is oscillating and when it is not oscillating.

Amertran transformers are employed in the audio system, enabling us to obtain a sufficient amount of amplification. This type of transformer has always been a leader in its field and has held the confidence of the radio world to its desirabilities since radio has come into its own.

The method of mounting the parts in their proper positions is unique. It is another one of the features of the set which takes the eye of the man who appreciates something good. All the parts of

the set, except those which are mounted upon the shielded units, are affixed to small bakelite panels which fit snugly in the bottom of the cans. These small bakelite bases are raised about one-half an inch above the bottom of the can by means of brass bushings. By mounting these bases in this manner it is possible to mount the fixed condensers, the grid leak holders, the sockets, etc., directly upon these bases. This method of mounting presents a clean-cut neatness and enables you to wire the units below the bakelite panels. The latter has a distinct advantage. Wiring leads can be made as short as possible, because there are no disturbing obstructions below the panels to hinder their course.

A VIEW OF THE ASSEMBLED RECEIVER WITH THE DETECTOR STAGE TOP REMOVED TO SHOW PLACEMENT OF THE COIL UNIT IN ITS SUPPORTING SOCKET

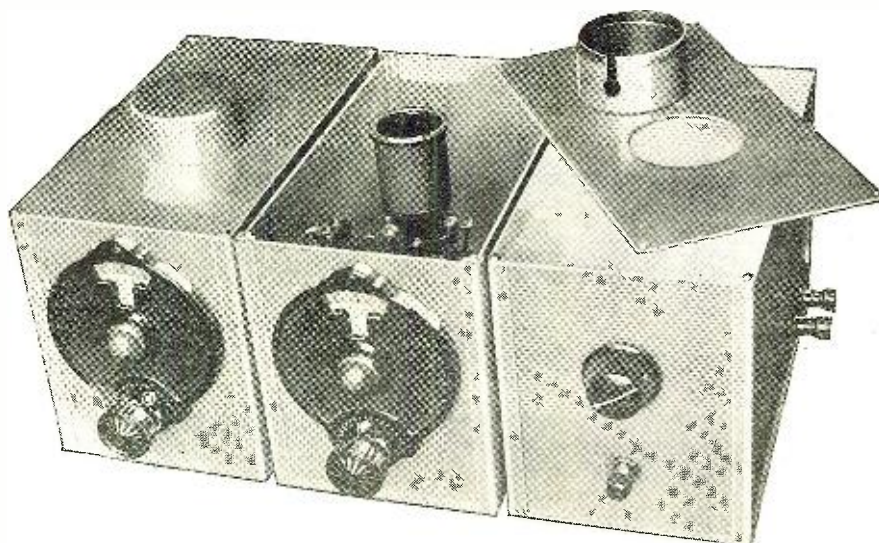

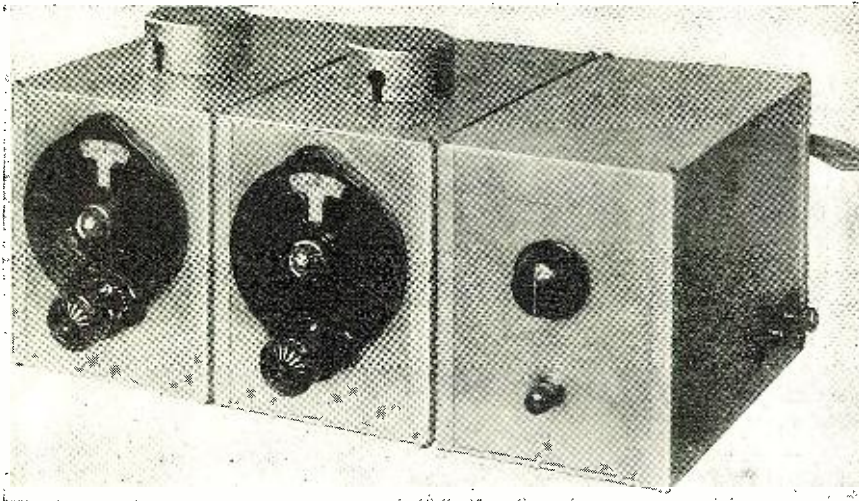

THE COMPLETED SHORT-WAVE RECEIVER, LINED UP AND READY FOR USE. THE SWITCH IN THE RIGHT HAND UNIT TURNS ON AND OFF THE CURRENT TO ALL OF THE TUBES.

The socket for the coils is mounted on $\frac{3}{8}$ " brass bushings and is raised to enable the coils to protrude high enough over the top of the shielded unit to make the interchange of the coils a simple operation.

Separate binding posts are employed to allow the operator to use any type of tube he might wish in the detector and audio circuits. There are individual "B" battery leads for every tube in the set, all fixed to a common "B—." Different "B" voltages can be experimented with to bring out the maximum efficiency of each individual tube. The set also has separate "C" battery connections for the two audio tubes.

Another important feature of this set is its absence of choke coils. Choke coils have the peculiar habit of causing fringe howls which hamper the quality of reception and also cause dead spots that paralyze the operation of the set over a small wave-length range. These hindrances are completely done away with in the S-W Four, due to its correct shielding characteristics and the manner in which the by-pass condensers were employed. When operating the S-W Four, you will find that it is alive over the whole wavelength range and is entirely free from fringe howls.

The dials are the best adapted to this set. A hairline indicator is part of the dial and helps considerably when attempting to log some distant station. The dial has a fine operating vernier which enables you to tune this set very accurately.

Coil Specifications

As mentioned before, the coils are of the plug-in type. They are handy and can be placed away in any small convenient place. If desired, coils can be supplied to enable you to obtain broadcast band reception. The coils' bases have five prongs, the cathode prong being the dummy. The detector and r.f. coils have the same number of turns on both the primary and secondary windings.

The number of turns on the coils are given as follows:

Coil	Primary	Secondary	Wavelength
A	5½	6½	17 to 32.5
B	5½	13½	31 to 58
C	9½	25½	57 to 110
D	15½	49½	104 to 204
E	19¾	82½	190 to 358
F	30¾	155	344 to 647

Operating Instructions

Full constructional and wiring details for assembling and wiring the S-W Four are contained in the drawings accompanying. However, before placing the finished units together, first connect the batteries to their respective positions on the back of the audio unit. Then place a tube in the audio unit and turn the filament switch to see if it lights properly. Then if both the audio tubes light correctly, connect the detector and audio tubes together by means of the plugs and jacks, and test the filament of the detector stage. Finally, test the r.f. stage. If all the tubes light properly, screw the tops of the shielded units in their respective positions, making sure that they are screwed down tight. This is very important, for if the cans are not

IN ADDITION TO SHOWING FURTHER MOUNTING DETAILS OF THE COIL SOCKETS THIS PHOTOGRAPH SHOWS HOW TO CONNECT THE BATTERY LEADS TO THEIR RESPECTIVE BINDING POSTS SO AS TO AVOID THE POSSIBILITY OF SHORT-CIRCUIT

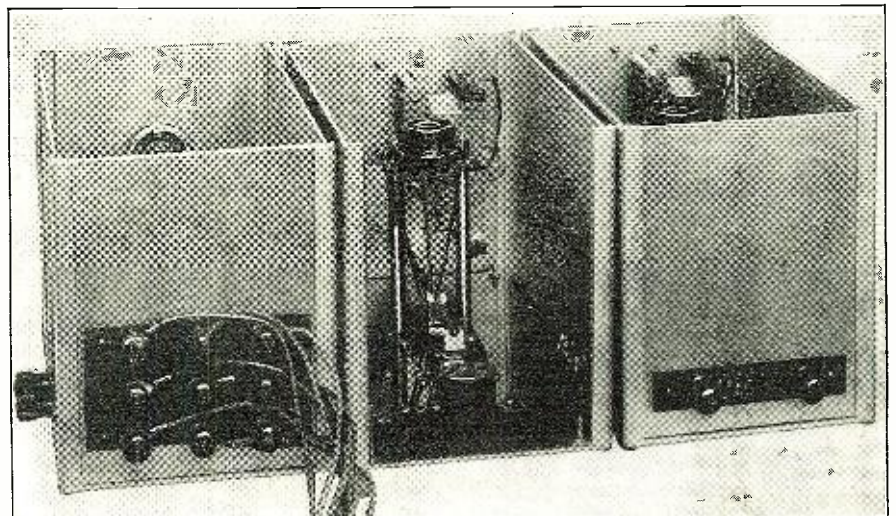

tight, they will cause scraping noises in the phones.

The tubes recommended are as follows:

A UX222 is employed in the r.f. unit; a UX112A is advisable in the detector unit; a UX201A is advisable in the first audio, and a UX112A or a UX171A may be used in the final audio stage. Make sure that the proper "B" and "C" voltages are used for the tube selected.

Now, when the batteries, the antenna and ground and the speaker are finally connected, plug in the matched set of coils and cover them with the shielded caps. Turn the filament switch. You should hear a slight rushing sound in the phones. If the set is squealing, turn back the regeneration knob, which is mounted on the front wall of the audio unit, to a point just below the position where oscillation began.

The numbers of the r.f. and detector dials do not always work together. To determine the proper relation between these dials, set the detector dial at 50. Then turn the r.f. dial around until you hear the noise level or most sensitive spot that you can obtain. You will recognize this sensitive spot, for at this position the rushing noise is greatest for position 50 on the detector dial. The general idea of tuning is to keep the two dials in step, indicating a sensitive state for every point on the detector dial. The reason I mention the detector dial is because it is the main tuning control of the receiver; however, the r.f. dial has an effect which must be taken into account always. The r.f. dial usually works in advance of the detector dial when like coils are used in the coil sockets. When the detector dial reaches 80, the r.f. dial may read 100. Here, only the r.f. coil should be changed to the next higher coil to tune for a higher wavelength. Now the detector reading will be higher than that of the r.f. dial and when the detector dial reaches 100, it should then be changed for the next higher coil. In this manner all the wavelengths will be reached by changing one coil at a time.

The regeneration control is easy to operate. Best results are not always obtained just below the point of oscillation. Stations may come in louder when the oscillation control is moved a little further away from this point. To adjust

(Continued on page 169)

Synchronization Still Is a Television Problem

A Suggestion for a Simple Method of Keeping Receiver and Transmitter Discs in Step

By THOMAS W. BENSON

THERE may be many problems to be solved and difficulties to be overcome before television becomes as commonplace as the radio set of today, but it is doubtful if any are of greater importance than that of synchronizing. And, judging from the advances made in this field, there is no obvious solution of the problem. Synchronizing might be compared to the weather, in that everybody talks about it but few do anything about it.

We find that the systems suggested to date are either too difficult or compli-

two clocks may be running at the same rate, but the motors may be out of step as the two clocks may show a difference in time. See Fig. 3. The motors must be put in step manually and they of course should retain their synchronism, but here we meet with the trouble of overcontrolling encountered in the more common system of full manual control of motor speed. It is quite some trick to frame a picture and keep it there . . . even if one can drive a car (which operations have been often compared in speaking of full manual operation of motor speed).

What television needs is a system whereby the disks can be brought to approximate synchronism. Then, once the correct speed has been obtained, they will get in step and stay there automatically. And the equipment to do this must be simple, inexpensive and if to meet with wide application at this stage of development must be within the ability of the average experimenter to construct. As a step to that end the writer proposes the system of synchronism to be described herein which to all appearances meets the above condition.

At this point let it be understood the device has not been brought to final, complete development. It is offered as a basis for further development work along this line. It follows, of course, that any system of true synchronism necessitates cooperation of the transmitter, but the system described herein requires but a minor change in the transmitter to make possible its use.

The first requirement is that the transmitter send a strong impulse at each revolution of the scanning disk. This of course could be done by a simple contact arranged on the edge of the disk which touches a light metal spring at each revolution. The edge of the disk is preferred

because the length of time the circuit is closed will then be very short, simply a pulse of current being the synchronizing signal. As shown in Fig. 1, the contacts close a circuit that acts to impress a small voltage on one of the grids of the tubes in the amplifier normally used to amplify the currents from the photoelectric cell or cells used with the scanning disk. Thus for each revolution of the disk a strong impulse will be transmitted, this impulse occurring when the lower scanning hole is leaving and the upper hole is approaching the scanning aperture. It will be evident that when

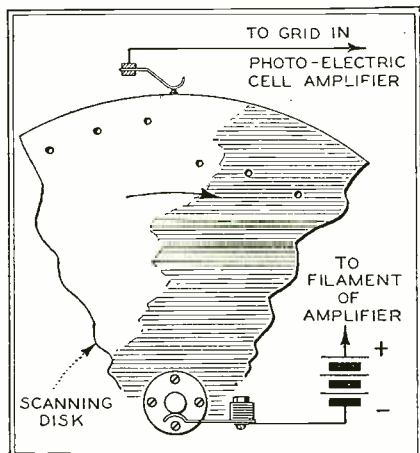

FIG. 1. ARRANGEMENT OF TRANSMITTER DISC FOR SENDING THE SYNCHRONIZING SIGNAL

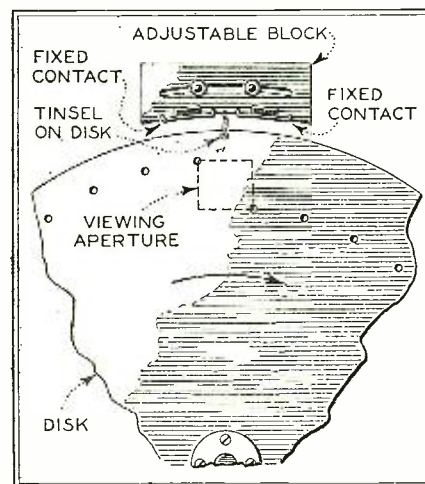
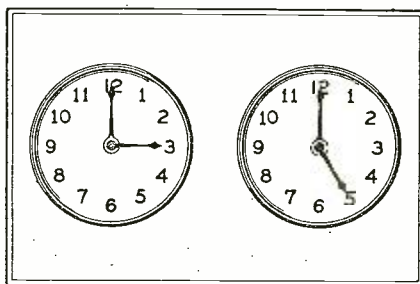

FIG. 2. DETAIL OF THE ARRANGEMENT SUGGESTED ON THE RECEIVER DISC

cated to use, such as the idea of using an alternating current motor on the same shaft as the motor driving the disk, the frequency of the current operating the former, or a control motor being controlled by the transmitter to provide synchronous operation of both transmitting or scanning disk and the disk at the receiver.

It might be well to point out that this system, as developed by the Bell laboratories and mentioned by Baird, possesses the same disadvantage as the plan relied upon by some designers of television apparatus. The latter plan is based on the use of synchronous motors where both transmitter and receiver are operated from the same power network with the assumption the motors will then stay in step. This is true to a certain extent but the promoters of this scheme forget that the motors operate isochronous, which does not always mean synchronous. To make this clearer it might be said the motors will operate at the same speed as

FIG. 3. TWO DISCS MAY RUN AT THE SAME SPEED JUST AS TWO CLOCKS MAY RUN AT THE SAME SPEED AND YET BE OUT OF STEP WITH ONE ANOTHER



the receiving disk is in synchronism with the transmitter this strong impulse giving a light spot will not intrude upon the picture except in the extreme upper left and lower right corners of the received picture and then but slightly.

Having obtained the synchronizing impulse, the problem is to make it control the receiving disk, which is a little more complicated but entirely practical. At the same relative point as the scanning disk, that is, midway between the so-called first and last holes of the spiral, the receiving disk has a few strands of tinsel fastened to the edge. It is important that the disk be kept well balanced and any additional weight, slight though it may be, should be counterbalanced by a small drop of solder at a point diametrically opposite.

Just clear of the top edge of the disk a block of wood is mounted which car-

(Continued on page 185)

ELEVATION AND PLAN OF THE CONTROL AND PASSENGER "CABIN" OF THE GRAF ZEPPELIN, SHOWING THE LOCATION OF THE RADIO ROOM JUST AFT OF THE NAVIGATING ROOM

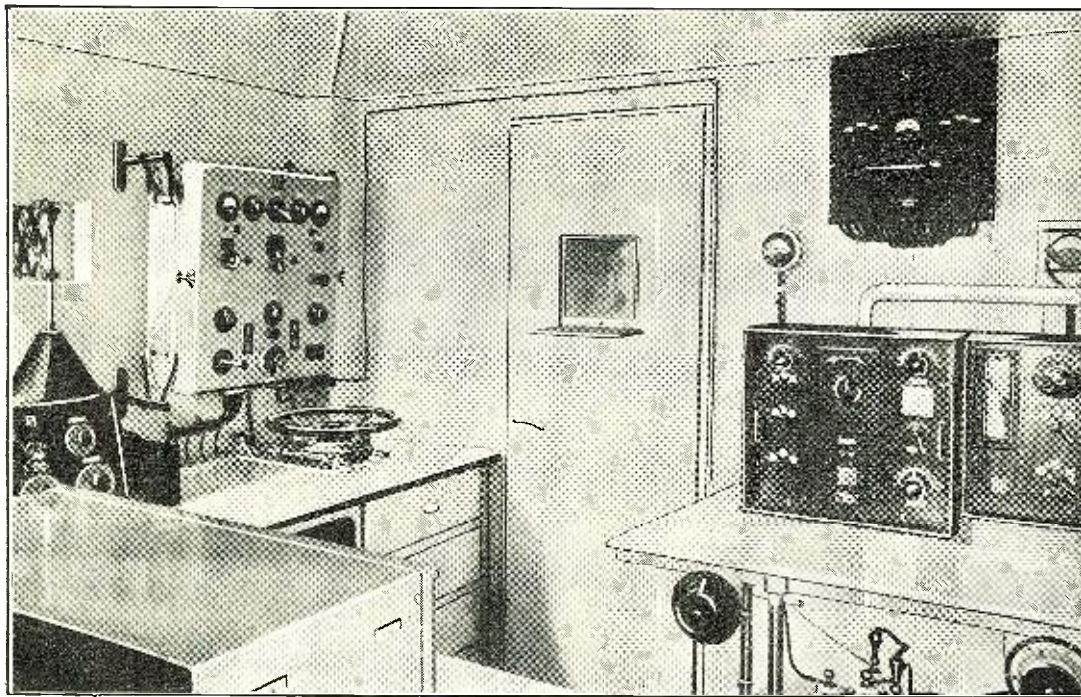
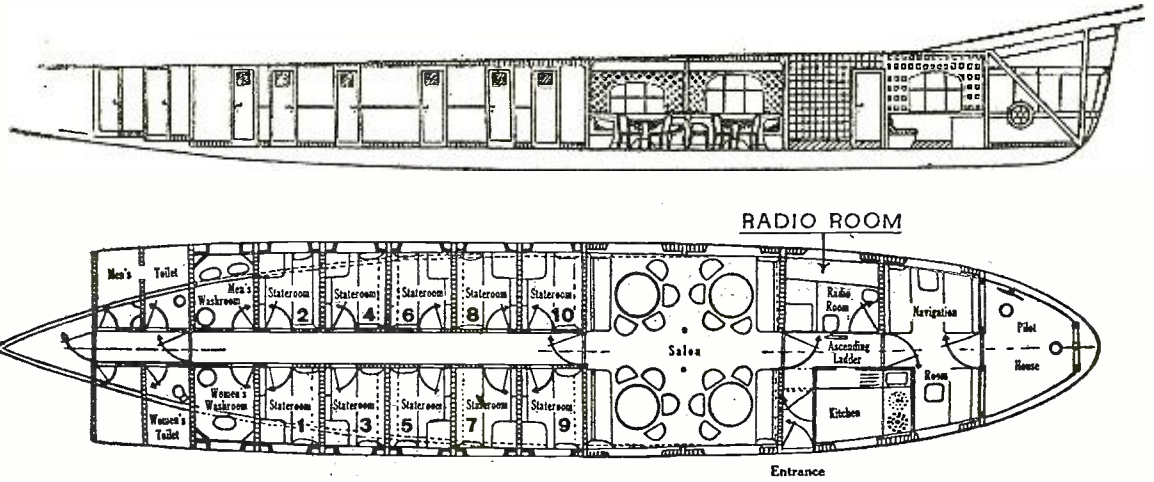

AT THE LEFT IS A PHOTOGRAPH OF THE RADIO ROOM ITSELF. THERE ARE TWO ANTENNA REELS, EACH CARRYING A TRAILING WIRE ANTENNA, WEIGHTED AT THE END. EITHER OR BOTH ANTENNAS CAN BE USED AT WILL, BEING REELED UP WHEN NOT IN USE

Radio—the *Graf Zeppelin's* Contact With the

BY LIEUTENANT T. G. W. SETTLE
U. S. Navy

THE radio shack of the trans-Atlantic greyhound of the air, Graf Zeppelin, is much like that of any other ocean liner. It is amply large, comfortable, well lighted night and day, and is more conveniently located for both passengers and operators than that of most surface ships.

The people of our country, while they have become notably "air-minded" in recent years towards heavier-than-air craft, are still woefully backward in their knowledge of and outlook upon the older and very different branch of aeronautics, that of lighter-than-air vessels. They still regard the airship as a highly experimental and very expensive competitor of the airplane. Such is far from being the

case. The two are competitors in no sense of the word, and as to the airship being highly experimental, you have but to talk with anyone who has been a passenger on one of the commercial vessels which "ply the air," or to do a little reading of the history of this type of craft. Before the war and immediately after the war, the German Airship Operating Company (called Delag), with their old-time and small Zeppelin ships, carried thousands of passengers between various points in Germany on schedule, on a dividend-paying basis, and without injury to a single one. Our public is more familiar with the trans-Atlantic crossings,

with passengers, mail and cargo, of the Graf Zeppelin, last fall.

The majority of our people, who are in the habit of viewing airships from a viewpoint somewhat distorted by their knowledge of airplanes, would be amazed at a view of an airship's radio room. Suppose, by some magic, Joe Smith, of Podunk, U. S. A., could be transported over the water and set down in the passageway between the radio room and the galley, in the "cabin" of the Graf Zeppelin, in mid-Atlantic. On his port hand (he wouldn't know port from starboard, but it would be on his port hand nevertheless) he would see a door and on it, on a neat

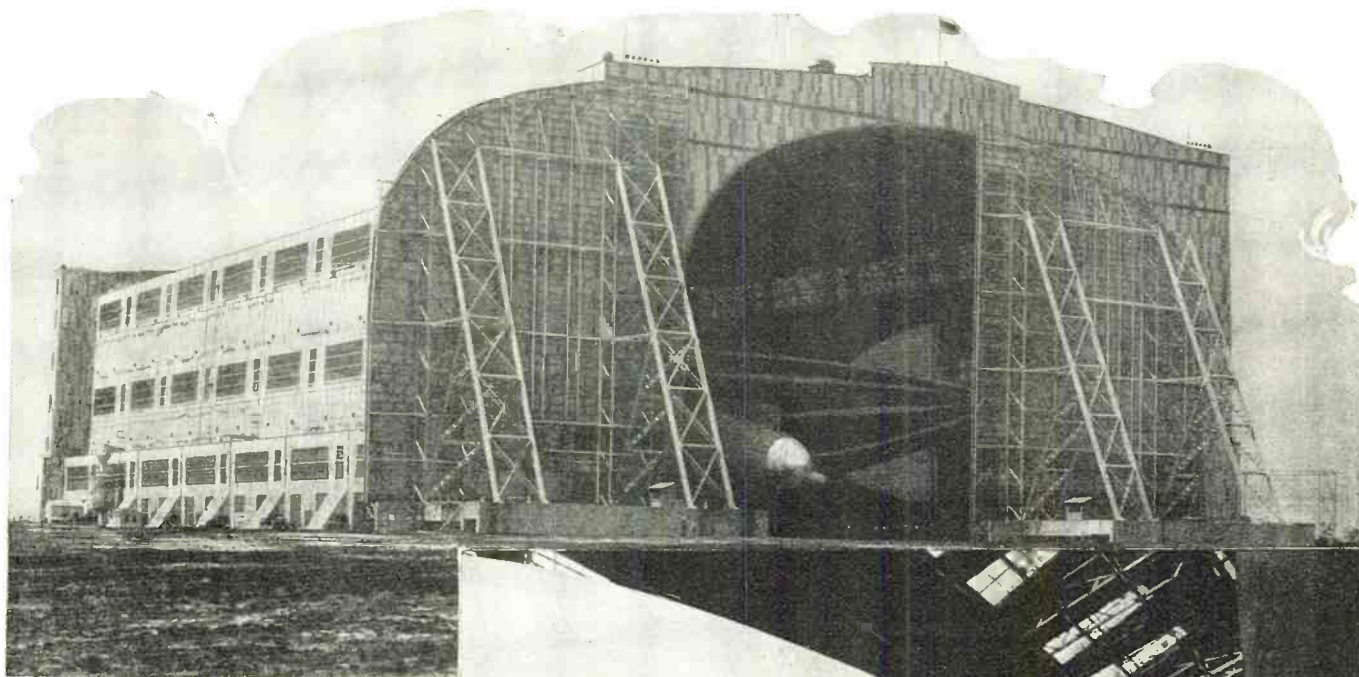

THE HANGAR AT LAKEHURST, N. J., AND—BELOW—THE GRAF ZEPPELIN ON HER FIRST AMERICAN VISIT

LIEUTENANT SETTLE has been communication and radio officer of the Shenandoah and Los Angeles for the past five years. He was one of the three U. S. Navy officer observers who made the return trip to Germany on the Graf Zeppelin last Fall. He is at present on temporary duty in Washington, in connection with the design of the two new 6,500,000 cu. ft. airships now building for our Navy.

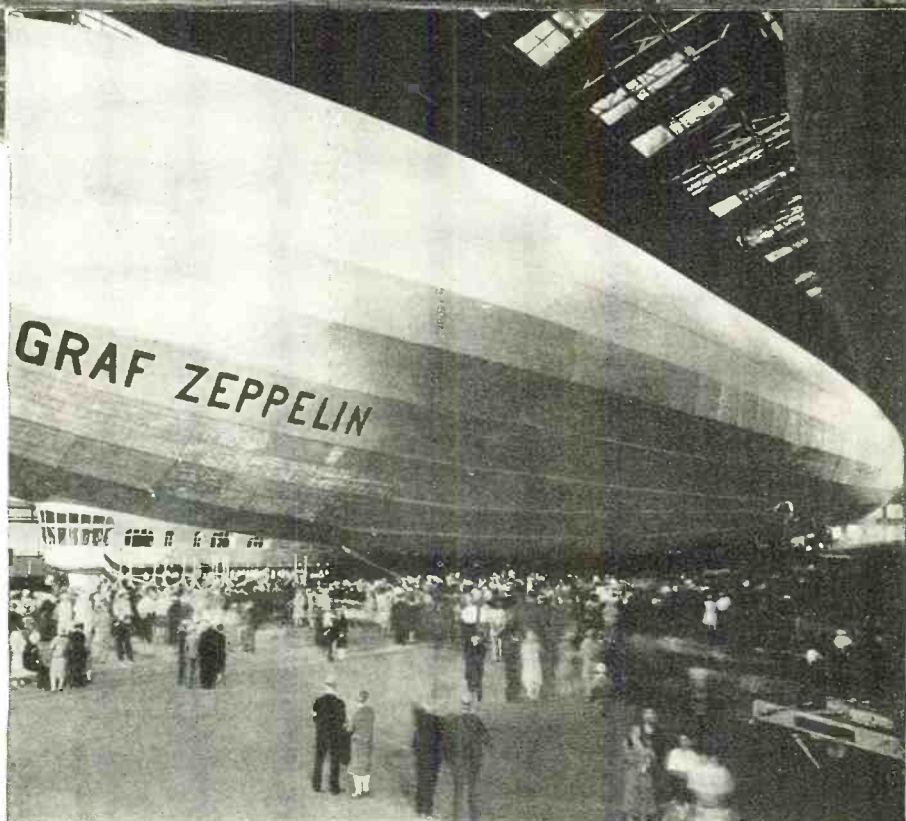

Only World

name plate, would be the German equivalent for "Radio Room." Now, Joe Smith, we will assume, was a radio fan back in Podunk, so he will immediately concentrate on that door. Midway down the door he sees a shelf with a sliding window, very like the arrangement at the stamp window at the home-town post-office. Just then a passenger comes through the door from the salon at the after end of the passageway, with a message to a chorus girl friend of his in London, making a date for two evenings hence. The passenger passes the message in through the window, an operator counts the words, places the usual unintelligible notations in certain places on the message form, looks up the charges and makes

change for the passenger. Joe Smith wonders whether if, after all, someone isn't just kidding him, and if he really isn't on one of those old and slow surface liners, on which he has crossed the ocean before. But then, he knows this can't be so, because the deck under him is as steady as the church floor at home, no rolling and twisting around, no smell and dampness of salt spray. He looks out of the window just abaft the galley and sees that there is a wind of gale force kicking up mountainous seas on the surface below; a large liner of the antiquated surface variety wallows around, shipping green seas over her "foc's'l," and Joe feels how miserably seasick he would be down there. An operator rushes out of the radio shack door and into the passenger salon with an answer from the London friend, saying she's dated up and suggesting the following evening. The radio officer comes aft from the

bridge. He wears a natty blue uniform, with the "Luftschiffbau Zeppelin" insignia on his cap. Smith eagerly accepts his invitation to inspect the inside of the radio room. They enter the sacred chamber together, and Smith gives up the attempt to reconcile what he sees with the knowledge that he is 1500 feet above the surface of the Atlantic, speeding along towards Europe at 60 miles an hour, in an airship, manned by a crew of 40 officers and men, with 24 passengers. He finds himself in a neatly furnished room, about 7 ft. by 8 ft. in deck area. In front of him is a desk extending the full length of the outboard bulkhead, and on which are located the main transmitters and receivers; at the center of this desk are the transmitting keys, the radio log book, and incoming and outgoing message files. Under this desk is the antenna winch housing. Smith sees two reels in this housing and is told that each reel carries a 120 meter long, trailing wire antenna,

THE DINING ROOM, WHILE NECESSARILY SMALL, IS COMFORTABLY FURNISHED AND AMPLE TO ACCOMMODATE THE FULL COMPLEMENT OF PASSENGERS. EXCEPT AT MEAL TIMES, IT SERVES AS THE LOUNGE OR SALON

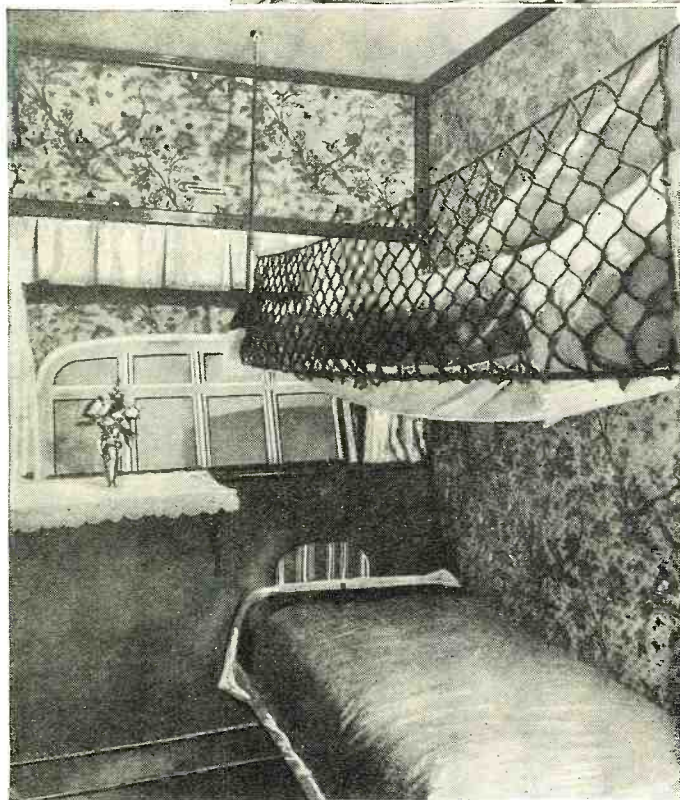
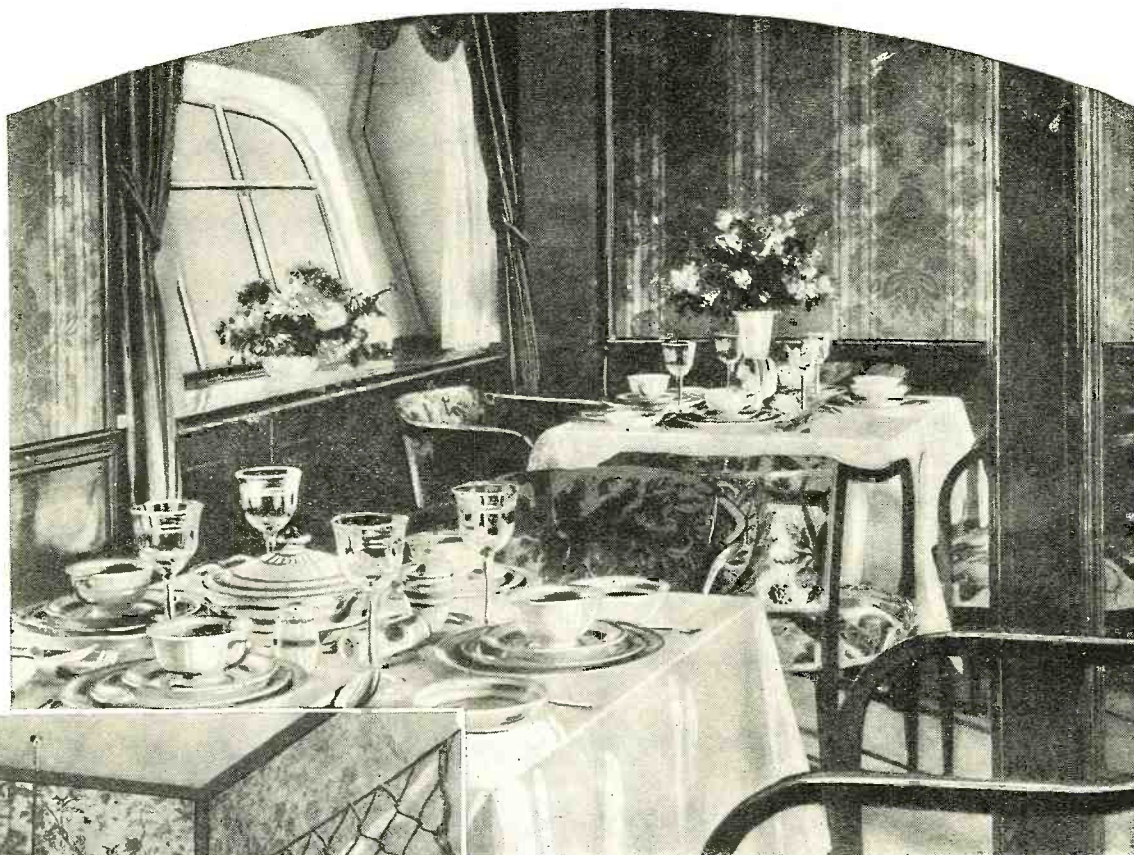

AT THE LEFT IS ONE OF THE PASSENGER STATEROOMS ON THE GRAF ZEPPELIN. NOT SO LARGE AS A STEAMSHIP STATEROOM, IT IS BOTH LARGER AND MUCH MORE COMFORTABLE THAN THE BEST RAILROAD ACCOMMODATION

ference from the engines of a plane. That reminds him that he hasn't heard any engines on this huge craft, but now, listening, he hears a distant drone. The radio officer says that that is the hum of the five powerful Maybach airship engines which run for day after day without even "coughing," driving the ship along the air lanes of the ocean. Smith realizes that he has been conversing in ordinary conversational tones of voice; he is told that no ignition interference troubles whatever from the engines are experienced by the radio people.

Graf Zeppelin's Equipment

Let us leave Joe Smith to pursue his hypothetical inspection of the Graf Zeppelin's radio room, while we investigate this equipment for ourselves.

As may be inferred from the above, the radio room is located just abaft the bridge and the navigating room, on the port side of the cabin. It is lined with reinforced balsa wood for noise insulation.

Two intermediate frequency Telefunken transmitters are installed. The main set is approximately 20" x 20" x 10" in size and is of the master-oscillator, power-amplifier type circuit, utilizing two 70-watt tubes in the amplifier circuit and one such tube in the master circuit. This transmitter has a frequency range of 100 to 1000 kilocycles, continuously variable. The frequency adjusting operation requires four settings. The emitted wave is optionally CW, ICW or voice modulated CW. The voice modulating circuit uses a 75-watt tube.

It should be stated here that an airship is an extremely efficient "radiator" from a power standpoint. The metallic ship's structure, which is thoroughly

with a lead weight on the outboard end of it. He is told that either wire, or both, can be "put out," depending upon the wavelength used. The weights on the ends of the wires are different, one a three-kilogram, and the other a four-kilogram weight, in order that, with both "out," they will spread or "fan" themselves in a fore-and-aft plane.

The operator turns on an electric light in the housing so that Joe can see the "insides" of it through the cellophane door. He accidentally steps on one of the small pedals at the base of the housing for an instant, and the wire from one reel which was "in," sings as it pays out. He had momentarily released the friction brake holding the reel. The radio officer says

"No harm done," throws in a clutch on the side of the housing, turns a switch, releases the friction brake again, and a small electric motor "hauls in" the wire. He explains that you can haul it in by a hand crank if you so desire.

On one end bulkhead is the radio compass receiver and coil setting dial. The coil itself is in the "bumper bag," projecting from the under side of the control car. This bumper bag is an otherwise hollow boat-shaped wicker basket, covered with fabric, and takes up the small shocks in making contact with the ground upon landing. This compass is very sensitive and accurate, and of considerable aid in navigating.

Joe has heard much of ignition inter-

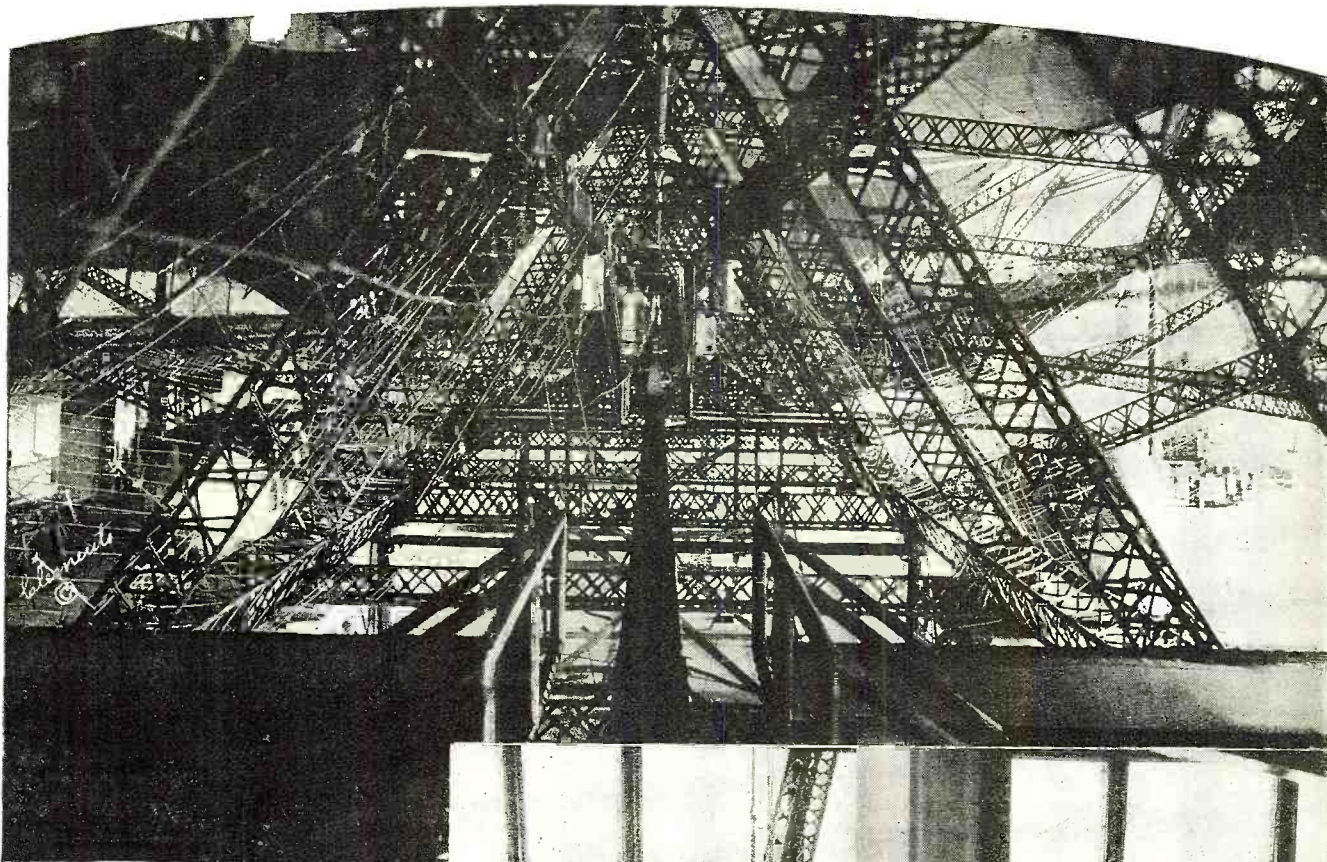

ABOVE IS SHOWN A VIEW ALONG THE "CAT-WALK" WHICH RUNS THE LENGTH OF THE DIRIGIBLE, INSIDE HER ENVELOPE. THE CREW'S QUARTERS AND THE FUEL TANKS ARE LOCATED IN THIS SECTION OF THE STRUCTURE

AT THE RIGHT IS A VIEW OF THE PILOT HOUSE, IN THE EXTREME BOW OF THE MAIN GONDOLA

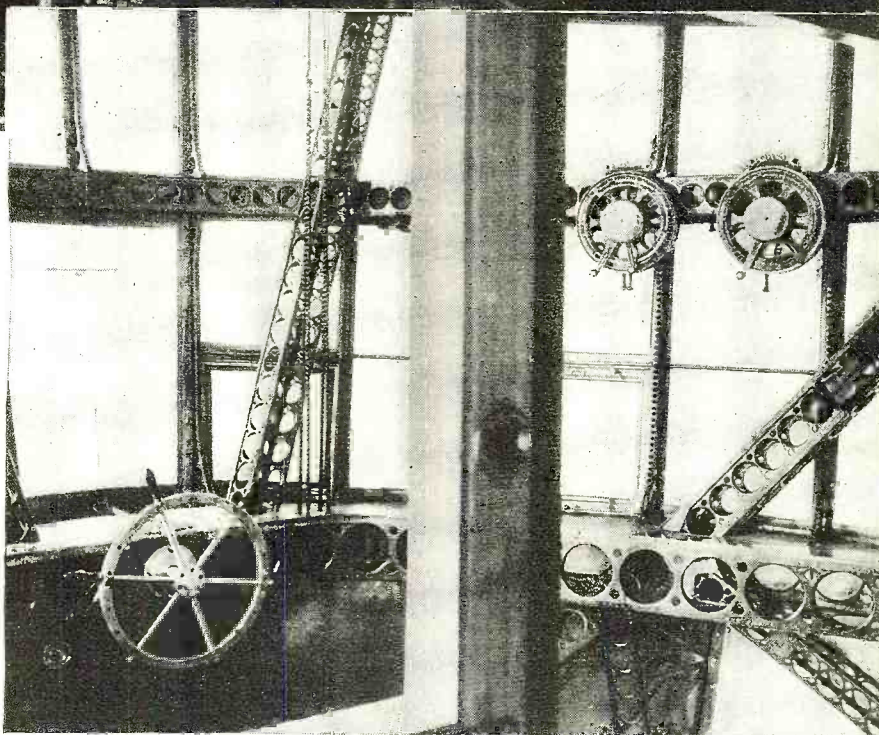

bonded electrically throughout, forms the "ground" or counterpoise. For a given power output, ranges are obtained from airships much greater than those possible on shore or from surface ships.

The main set "send-receive" switch is built into the transmitter, but has an extension handle within easy reach of the operator on watch.

An auxiliary intermediate-frequency 70-watt transmitter is installed. A low-powered high-frequency transmitter was carried on last fall's voyages for experimentation only, no traffic being handled by it.

The nominal range of the main set is 1500 kilometers CW, and 400 kilometers voice modulated, but these ranges, of course, are greatly exceeded at times.

The power sources for the transmitters are windmill generators, mounted in the air stream outside the cabin. The plate supply to the main transmitter is 1500 volts, d.c. A "ship's battery" is provided and is an emergency power source. A small gasoline engine-driven emergency generator is also provided.

Two traffic receivers covering all used frequencies are installed; they are very sensitive and selective Telefunken receivers; seven-tube superheterodynes, with two audio-frequency amplification stages, one of which may be cut out optionally.

The receivers are completely shielded, both externally and interstage; they are single drum-dial tuned; they have an internal coil shifting arrangement for shifting frequency bands.

A small regenerative high-frequency marine type receiver was carried last fall.

The Graf Zeppelin carries a radio officer and two operators. They, of course, have no responsibilities towards any electrical apparatus except their strictly radio equipment. A "general" electrician is carried in the crew to care for the electric galley, lighting circuits and other electrical gear.

Miscellaneous auxiliary gear is installed in the radio room, such as a receiver battery charging panel.

New Apparatus

It is understood that higher power high-frequency equipment has been installed on the Graf Zeppelin during the past winter. No details are available, but on the first crossing this year, it is planned to have an announcer on board transmit (by voice) on the high-frequency set, this to be rebroadcast on "broadcast" frequencies by a chain of stations in this country. It is further planned, according to press notices, to have an airplane meet the Graf Zeppelin a short distance offshore, and to have a two-way conversation between plane and Zeppelin, rebroadcast by the group of stations. The call letters are DENNE.

(Continued on page 184)

Sound Amplifiers

A tremendous new market which manufacturers of equipment are beginning to visualize, and which offers exceptional opportunities to the custom set builder, the dealer and professional radio men in general

BY
S. GORDON TAYLOR

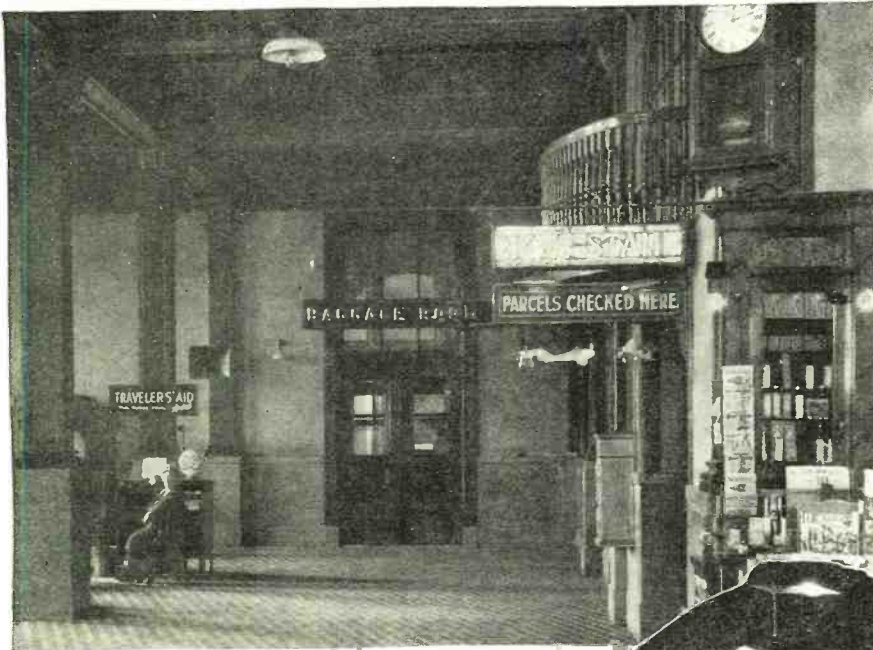

Courtesy of Samson Electric Company

ABOVE—IN THE LEFT MIDDLE BACKGROUND CAN BE SEEN THE TRAIN-ANNOUNCING LOUD SPEAKER IN A MODERN RAILROAD STATION

AT THE RIGHT—SOUND AMPLIFIERS MAKE IT POSSIBLE TO SUPPLY "RADIO IN EVERY ROOM" IN THE LARGE HOTELS



Courtesy of Pennsylvania Hotel

THE field of power amplification is one deserving of the most careful consideration of every radio man, and, I might almost say every business man, because this field is one the effects of which are going to be almost unbelievably far-reaching. It is safe to say—and this is a conservative estimate—that the coming year will see the installation of not less than 100,000 power amplification systems for commercial use. Heretofore the surface of this field has scarcely been scratched, even though during the past year, through the development of talking movies, power amplification has been extensively adopted in theatres.

Just to consider a few of the possible applications of power amplifiers—there are 26,000 hotels in the United States today, every one of which is a logical prospect for a power amplifier system of some kind to reproduce radio and perhaps phonograph programs for distribution to the public rooms or to the individual guest rooms. There are 73,000 hospitals and institutions which are logical prospects for systems which will permit the distribution of programs to the bedsides of patients through the use of individual head phones or through the limited use of loud speakers. There are innumerable local meeting rooms, dance

halls, etc., a great many of which will sooner or later install power amplifiers for the reproduction of dance music and addresses. There are 263,000 school buildings, a great majority of which will eventually employ amplifiers to bring special educational radio programs directly to the classrooms and also to make it possible for school heads to address entire student bodies, either in an individual school or, via radio, in all schools within the city.

In addition to all these there are countless local stores, confectionery parlors, restaurants and assembly places where loud speaker systems will be employed as entertainment or advertising features.

A Fertile Field for Servicemen

From an economical as well as a practical standpoint the power amplification field starts off in a better position than did radio. The demand for radio receivers came before receivers had been developed to an even partially satisfactory point. On the other hand, power amplifiers have already been developed to

an extremely high degree, in advance of the anticipated demand. All that is required now in this new field is facilities for production and installation to meet the demand which is already evidenced on every side. There need be little worry about the production of suitable amplifier equipment, because a large number of manufacturers are already in production and are prepared to step up their production to keep pace with demand. The most pressing need right now is for men in the field to do the actual installation work. *Right here is a tremendous opportunity for the professional radio man who has heretofore been engaged in set building, radio installation or engineering work.* His knowledge of audio amplification is already developed to a degree which in most cases will permit him to shift his activities to this new field without any extensive preliminary training. He is, therefore, qualified to step right into the work, perhaps in a comparatively small way in the beginning. With the experience gained through the small beginning he should soon qualify to handle

Innvade New Fields

AT THE RIGHT IS SHOWN AN OUTDOOR SKATING RINK EQUIPPED WITH SOUND AMPLIFIER AND LOUD SPEAKERS. EITHER PHONOGRAPH RECORDS OR RADIO PROGRAMS MAY BE USED TO SUPPLY MUSIC OR OTHER ENTERTAINMENT

BELOW—THE PROBLEM OF ADDRESSING A LARGE STREET AUDIENCE BECOMES CHILD'S PLAY, WITH MODERN SOUND AMPLIFIERS



Courtesy of Samson Electric Company

render him. That this is true is evidenced in the fact that some hotels have spent \$50,000 or more for such installations, and one large hotel organization has invested over \$1,000,000 in the installation of equipment to enable them to provide radio reception in every room of the several hotels which they own. Even at this early stage of the development of this field, installations costing several thousand dollars are becoming quite common. One dancing academy has recently made an installation consisting of two automatic phonographs, together with power amplifiers and loud speakers in which a total of approximately \$3,000 was invested. On this particular job the installation man made a profit of close to \$500 and was able to complete the entire installation in less than a week's time.

This particular job is of interest because the whole thing arose from a little careful observation on the part of the man who made the installation. It had been the practice in this academy to employ four musicians to provide the musical accompaniment for the dancing instruction during the daytime. Through the phonograph and amplifier installation the relatively high salaries paid to these men were saved and the music provided was as good as that which had been supplied by the musicians. As a matter of fact, the music was superior, because high-grade phonograph records made by leading dance orchestras were employed. In any event, the saving in salaries alone was sufficient to pay the upkeep cost of the new equipment and to pay off the initial cost in less than a year.

The Serviceman's Personal Qualification

Assuming that the reader is qualified to undertake the type of installation work outlined above and desires to enter this new field, the question arises as to where he is to start and how he is to go about it. Before he can undertake an installation job it is obviously necessary to first get the job. This means that he must be a salesman as well as an installation man. There is the advantage in this connection that he need have little



Courtesy of Samson Electric Company

any type of installation that may come his way.

It will be realized, of course, that the demands for power amplification will vary. In one case, as in a small store or restaurant where the installation is to be used only in the reproduction of radio programs and perhaps phonograph selections, nothing more than a modern radio receiver may be required. Other projects somewhat more extensive in nature will involve the use of separate power amplifiers capable of delivering the equivalent of the maximum output of a push-pull stage, employing a pair of 245 tubes. Finally, in the really high power amplifier installations, larger amplifier systems employing two or more of the 250 type tubes will be required. All of these types of amplifiers are alike except for the amount of power involved and all are familiar to any radio man who has had even a moderate amount of experience in this field. The only part of the work in this new field with which he may not be entirely familiar is the distribution wiring for large jobs and the proper circuit arrangement and physical placement where several loud speakers are to distribute the

output of a single amplifier. These points need not be a subject of any special worry to the man entering this new field, however, because he will find that many of the manufacturers of amplifier equipment stand ready to equip him with technical literature covering these subjects. Moreover, on large installations special technical assistance will be willingly supplied by the manufacturer's engineering department.

In developing a power amplifier installation business there will be found the great advantage that the average sale involves a considerable sum of money and a decidedly worth-while profit. This business is unlike the receiver sale business, inasmuch as the installation of a power amplifier in a store, school or hotel represents a business investment on the part of the purchaser. Such a sale does not depend on a hobby or a whim, but the purchase is made in exactly the same way as a store proprietor would purchase a delivery truck or a new show case. Being an investment, the amount of money such a man is willing to spend will depend directly upon the business-building service which the installation can

AT THE RIGHT—THE USE OF SOUND AMPLIFIER HORNS AT EITHER SIDE OF A DEMONSTRATION STAGE IN CONNECTION WITH A FOOD SHOW

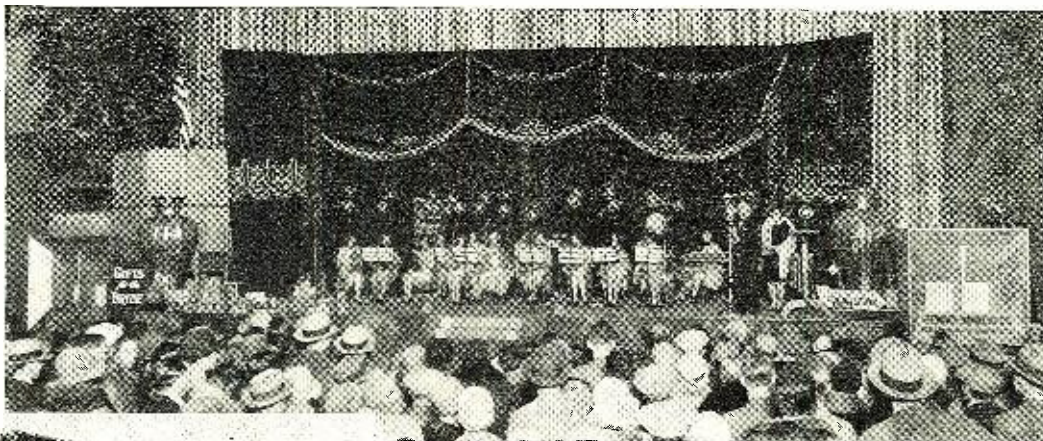

BELOW—THIS IS THE TYPE OF VOICE AMPLIFIER HORN WHICH WILL BE USED FOR GIVING ORDERS IN CONNECTION WITH THE LANDING AT LAKEHURST OF THE DIRIGIBLE GRAF ZEPPELIN

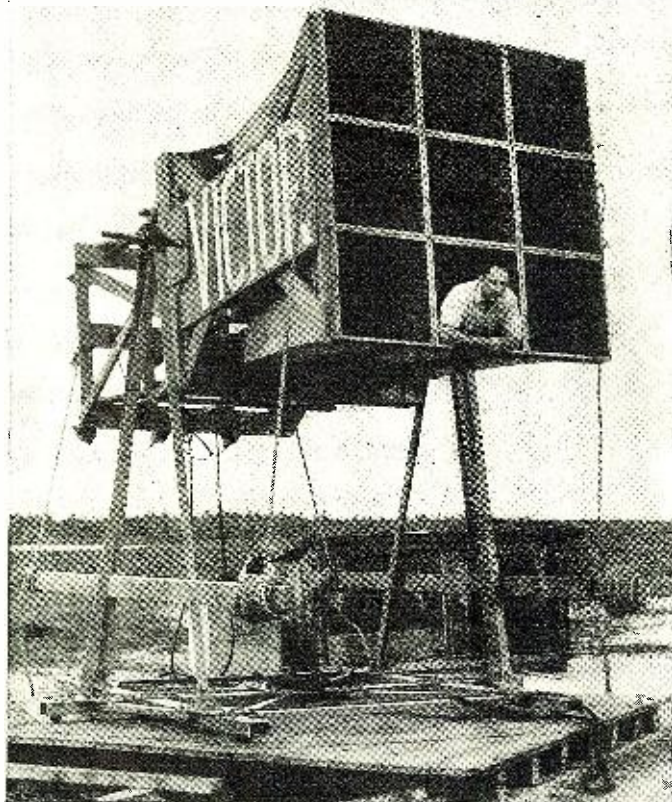

Courtesy of Victor Talking Machine Company

worry about outside sales competition. Manufacturers of power amplifier equipment do not employ salesmen to cover any territory intensively. Moreover, if a salesman were to go into a territory from the outside he would lack the personal contact enjoyed by a local man. As a matter of actual fact, the manufacturers of power amplifier equipment are only too glad to have contacts and to do business with local men whom they feel are capable of making workable installations and they will extend every possible effort to co-operate with such men.

One very important factor in the success to be met in building up a business of this kind is a careful preliminary study of the local market for installations of the types under discussion. For instance, before approaching a prospect, thought should be given to the selling points which are likely to influence him. If the prospect be a restaurant owner, for instance, he may be very much impressed by the fact that through the installation of a simple radio receiver and power amplifier he will be able to reproduce in his restaurant the dinner music broadcast from

amplifier to reproduce the output of an automatic phonograph.

Other good sales arguments may readily be found. For instance, this same restaurant owner may suffer from the competition of one or more neighboring restaurants. In that case, other conditions being equal, he can gain the edge on competition through the provision of high-grade entertainment, such as can be provided by the installation on which he is being sold. There may be many other local considerations which, if studied in advance, would help to create sales. This is one reason why a local man is in a better position to sell installation of this type than is an outsider. The local man is more likely to be familiar with local conditions and can, therefore, plan his sales arguments to fit in with the local conditions.

In the beginning it is wise to concentrate the sales effort on two or three smaller installations, such as those that might be required in a local meeting place, or a restaurant. Then gradually the scope of sales effort can be extended to somewhat larger jobs. This method has

the advantage that it starts with the simplest installations to provide experience. At the same time, through these installations a certain amount of publicity is obtained which helps in closing larger transactions and direct contacts are developed with the equipment manufacturers.

Home-Built Versus Manufactured Apparatus

One of the questions which will arise in the mind of the installation man is that concerning the equipment to be used. In some cases his inclination will be to build the amplifier and power supply units himself, and the radio receiver also if one is to be used. This is a subject deserving of careful consideration. A little thought and investigation may show that it will be more profitable to buy ready-made equipment and limit his activities to the actual installation. With this idea in mind it is by all means advisable to collect complete data on the equipment available on the market. Where the names of manufacturers of this equipment are not known, many can be found by consulting the advertising pages of this publication. Also, in the future articles of this series a great deal of the available equipment will be shown in the illustrations.

It is sometimes advantageous in the beginning to assemble the amplifier and power supply unit from standard parts. This is particularly advisable where one may not be too sure of his knowledge of power amplification. By this means he can gain complete familiarity with the principles and circuits involved and can thus build up a valuable practical knowledge which will serve him in good stead when he later has occasion to buy ready-made equipment. This plan also has the advantage that it provides a larger margin of profit on each transaction—very often an attractive feature when building up a new line of business. After a business gets under way it may be found more desirable to drop construction work in order to concentrate on installation and selling activities. This procedure is only suggested, of course, because this is one of the problems every man in this field must solve for himself in the light of his own particular conditions and facilities.

Courtesy of Samson Electric Company



Courtesy of Samson Electric Company

Some Practical Applications

In addition to straight installation and possible construction work there is another possibility in this new field. There are a great many instances where a power amplifier used in conjunction with either a phonograph or a radio receiver could be rented out on special occasions. In one small town in eastern New York, for instance, a radio man built up a portable power amplifier outfit which he rented to a local lodge one night each week to provide music for the weekly dance. With the amplifier he supplied a radio receiver and a small portable phonograph. He, himself, operated the installation. If there was good dance music being broadcast by any of the nearby stations he would reproduce the music picked up by the radio receiver. If no suitable dance programs were available, or in the summer when static conditions were bad, it was only necessary to throw a switch to connect the phonograph in place of the radio receiver. Thus he was able to provide a continuous and high-grade program throughout the evening. Not only did he secure a worth-while income from this one contract, but in addition he was frequently called upon to install the equipment in other places, particularly in connection with church festivals, lawn parties and other dances. On the occasions of broadcasting of special events he was always able to find a local storekeeper who would rent the outfit for that one occasion.

A college man in an eastern city followed this same practice. He made an arrangement with the owner of an outdoor skating rink to provide music every night during the winter that the skating rink was open. This provided him with a substantial income during the winter. In the summer he arranged with the owner of a small resort hotel to provide dance music for an outdoor pavilion owned by the hotel management. In other cases of this kind arrangements have sometimes been made to rent out equipment to provide dance music, in payment for which the owner of the equipment would receive a percentage of

THE BAND-STAND, BOTH IN PARKS OF LARGE CITIES AND IN PUBLIC SQUARES OF SMALL TOWNS (AND PERHAPS ESPECIALLY IN THE LATTER), TAKES ON NEW SIGNIFICANCE. INSTEAD OF FILLING IT WITH PERFORMERS OF MEDIOCRE TALENT, MODERN SOUND AMPLIFIERS MAKE POSSIBLE THE ENJOYMENT OF REAL MUSIC, EITHER FROM A CENTRALLY LOCATED BAND OR ORCHESTRA OR FROM RECORDED OR BROADCAST PROGRAMS. TO THE LEFT IS A LOUD SPEAKER EQUIPPED BAND-STAND IN LIMA, PERU

BELOW—ANOTHER EXAMPLE OF "RADIO IN EVERY ROOM" OF A HOTEL



Courtesy of Pennsylvania Hotel

WHO and what constitutes the market for sound amplifying equipment? As Mr. Taylor points out, there are some 26,000 hotels in the United States; 73,000 hospitals; 263,000 school buildings; innumerable lodge and other local halls and dance halls; countless restaurants, confectionery parlors and other stores and assembly places.

Each of these groups is a logical market for power amplifier equipment, for the reproduction of radio programs, phonograph records, and in some cases for direct voice pick-up and reproduction. Each of these three "pick-ups" is readily adaptable to the same basic loud speaker system.

For radio reproduction, a radio tuning unit feeds into the amplifier; for phonograph reproduction, a simple pick-up device is all that is necessary; while a microphone suffices where direct voice reproduction is desired.

the gate receipts. In at least one case a very profitable arrangement was made whereby the owner of the amplifier equipment received a concession for the sale of soft drinks, etc.

In view of all of the possibilities suggested in this article it is quite obvious that any man who is qualified for this type of work may profitably consider participation in this field. For the man who at present may not be fully qualified technically, much will be found in the succeeding articles to help him. Certainly the whole layout is one worthy of very careful consideration either as a possibility for full time work or as a side line.

It will be the endeavor in the succeeding articles of this series to provide a great deal of data which will be useful to the radio man who desires to specialize in the sale and installation of amplifier equipment. Descriptive material on different types of amplifiers, both ready-made and those to be constructed from available parts, will be given. Also there will be comprehensive data on special types of radio receivers. Obviously phonographs will play a rather important part in a great many future installations and these will not be overlooked in this series of articles.

Of perhaps greatest importance will be numerous photographs of various types of installations that have actually been made, together with descriptions of the various features and problems of these installations.

What Are the Facts About Television?

By ARTHUR H. LYNCH and DR. C. FRANCIS JENKINS

THE Fourth Annual Convention of the *Institute of Radio Engineers* was held in Washington last May. At the Convention banquet, Dr. A. Hoyt Taylor, President of the Institute, was Toastmaster. After introducing several very prominent radio men who occupied places at the speakers' table, he called for a few impromptu remarks from Dr. Lee DeForest, inventor of the audion, or, as we have come to know it, the vacuum tube.



"TELEVISION, THE TWIN WHICH STUTTERS SO BADLY"—DR. LEE DEFOREST

Rising to the occasion from an inconspicuous table and bubbling over with that sparkling humor which is one of his most charming characteristics, the famous inventor delivered one of the simplest, most sensible, shortest and most satisfying speeches of the evening.

"Ladies and gentlemen," said he, "you are celebrating the anniversary of the birth of radio. Radio has matured greatly, has married and we now have two new babies. I would like to tell you just a few things about these twins. One has begun to talk a bit. Its voice is still a bit raucous, but it is showing the effect of cultivation and soon it will be as sweet as it is already powerful. I am speaking of that marvel of many companion sciences, the talking motion picture."

"Then there is that other twin which stutters so badly and suffers so from astigmatism, the twin which you have so well named 'Television'."

Such an apparently pessimistic presentation of fact coming from some other scientist might be discouraging. But when statements like these are made by a man like Dr. DeForest you may always count upon his carrying on and leaving off with a picture totally at variance with the

mental conjuring his first remarks engender.

As is usually true with his speeches, this one was of just such a nature. Dr. DeForest has been a pioneer in radio long enough to have experienced the heartaches which are the lot of most pioneers and has emerged from his failures and disappointments and reverses with a patience and optimism which presuppose a natural tendency toward optimism and are only fully developed by time and hard knocks. Some folks, tried as he has been, would long since have lost confidence in everything and perhaps, as a consequence, become very bitter.

Starting as he did, from an abyss of pessimism, he painted a picture of radio, from its early days, to the radio we know today. It has been a very rough road. It has been surrounded with a romance hardly to be duplicated in any other business. Radio has grown in a very few years from a business in which the total number of dollars, invested then, is now more than matched by millions of dollars. Radio is directly responsible for the meteoric rise of many young men from financial insignificance to the status of millionaires. Radio, in a few short years, has so materially benefited almost every other industry in our country as to make its effect almost inestimable.

Few, if any, scientists of twenty years ago would have dared to hazard a guess which would in any way encompass in its scope those things which have actually come to pass as a result of radio progress. Summarizing them would require more space than we have available. What prophet of twenty years ago, for instance,

would have dared to say that today an explorer at the South Pole would be in constant communication by radio telephone not only with his home city and nearly every other city on the globe, but also in a position to chat now and then with a similar exploring party encamped north of the Arctic Circle? Who, even so recently as 1909, would have dared suggest that a man would sit at his telephone in New York and exhort his wife in Paris to refrain from a voyage over the Atlantic, aboard an air liner?

Who would have dared to predict that a great political campaign for the Presidency of these United States would be carried into the homes of almost every family in them? Who would have believed the man who would have dared to suggest that folks in all sections of our country would dance to the rhythmic music of a single orchestra playing in London?

But all these things have been brought about. We accept them today as a part of our daily lives in much the same fashion as we accept the sunrise. And all this leads us to the discussion of the problem now facing radio's master minds, the subject which has been dreamed of and which is gradually coming out of babyhood under the patient and intelligent guidance of men like Dr. DeForest.

Television is today in much the same state that radio was in about 1900. You

DETAILS OF THE TELEVISOR TRANSMITTER WHICH WAS USED AT EAST PITTSBURGH LAST YEAR; (L1) THE LENS, (D) SCANNING DISC, (L2) SECOND LENS CONCENTRATING LIGHT ON THE FILM (F), AND THE PHOTO ELECTRIC CELL (P)

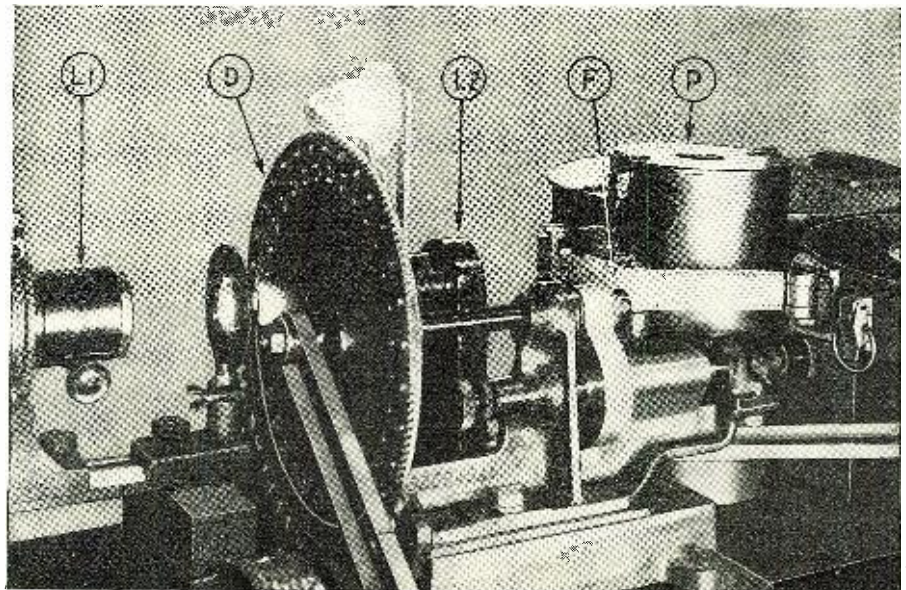

may remember that the sending of a few dots from one point to another a few hundred miles apart was somewhat of an achievement in those days. The men who did it were heralded as the forerunners of a new era in communication. They were, well—that is just about where we are with television today.

A few months ago a young engineer named James Millen working in Boston received television motion pictures sent from the laboratory of Dr. C. Francis Jenkins in Washington, D. C.

"The beginning of a new day," was what some of the papers said of his work. Some of the opportunists and pseudo-scientists had visions of home telemovies of all the leading sports events, and the appearance of such over-optimistic reports in the newspapers made many folks believe that these things were "just around the corner." That, of course, is just bunk. There is still much to be done before that very wonderful day arrives. But it will arrive. There is very little doubt of that.

As a result of the over-optimistic ballyhoo which rose like a tidal wave just before the last political campaign, many folks were led to believe that a television receiver or a television attachment for their present receiver would be marketed in time for them to see as well as hear those wonderful events. Truly that was something worth waiting for. The regular radio business suffered quite badly, as a result. Folks had all sorts of notions about television. Chief among these notions were the ideas that the machine, when it was introduced, would be small and very cheap and easy to operate; that it could be hooked right onto the regular receiver and the National Convention or the World Series or the Grand Prix Race would be thrown on a screen on the living room wall with all the clarity one now finds in the movies.

Well—that's just a dream, for some time to come.

It would have done the newspaper per-

TELEVISOR IN USE AT WRNY DURING EARLY ATTEMPTS AT TELEVISION BROADCASTING

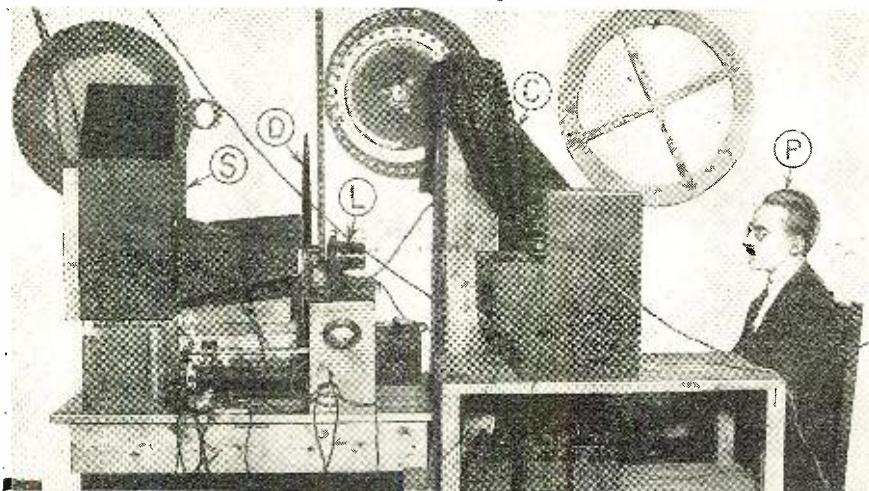
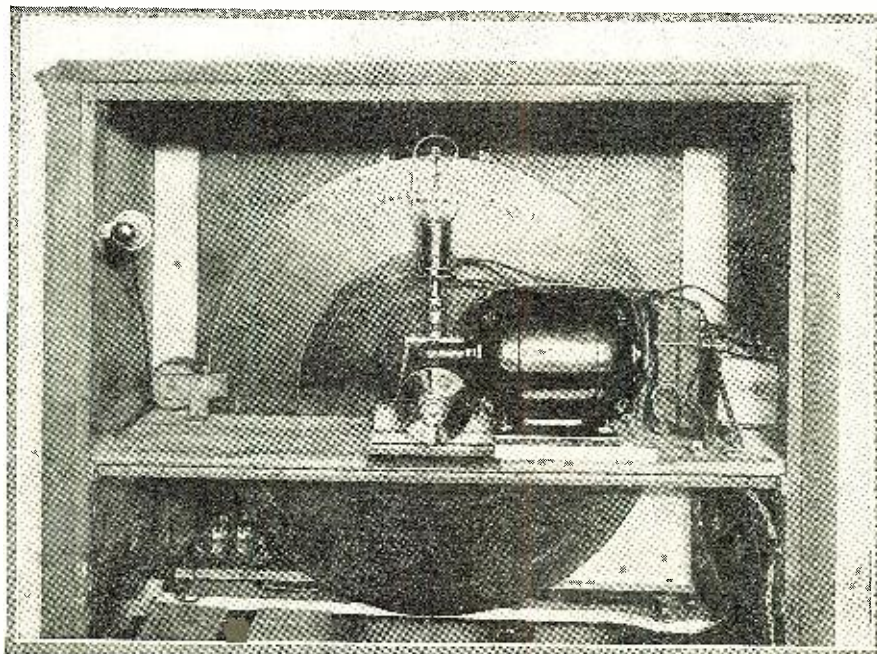

THE BAIRD TRANSMITTER AS SHOWN DURING EXPERIMENTS A YEAR AGO. S IS THE LIGHT SOURCE; D THE SCANNING DISC; L THE LENS; AND C A CLOTH COVERING THE PHOTOELECTRIC CELLS

petrators of such bunk a great deal of good and possibly put the fear of God in their hearts to hear the most eminent engineers in the country chat about the problems of television at the *Institute of Radio Engineers'* Washington Convention.

It is far from my purpose to lead you to the belief that television is impossible or that it is not worth having, even if possible. We will have it. We will have it in much the same fashion as described last year as being "just around the corner." But we won't have it immediately, and as Chick Sale so aptly remarks, "I'll tell you why."

In order to get a true understanding of the situation as rapidly and as easily as possible, let us get the reason for the "movement" in the regular movies. The present day movie is the application of a combination of machines, based on very thoroughly developed scientific research, designed to take advantage of certain physical characteristics of our eyes and thus make us believe we see something which we don't see at all. The movie people are doing a very fine job of "kidding" us and they are always attempting to do a better one. The movie of only a few years ago was not much better than the best television of today. So there is hope.

In order to make the pictures "move," a number of still pictures, with the various objects in them in different places with relation to each other, are flashed before our eyes. Each picture is actually motionless for the very small fraction of a second it remains on the screen. After our eye has seen it, a shutter is automatically carried before the projector and the picture is cut off the screen and the screen is actually in total darkness while another picture is put in place automatically, and, like the first one, is flashed upon the screen.

There is a certain lag in the functioning of our eyes sometimes called "persistence of vision," and as a result there is a blending of the pictures "shot on the screen," resulting in a reaction on our brain which makes us believe that the picture really moves. By a painstaking application of the knowledge of these optical illusions, motion picture producers have been able to present us with some very pleasing results.

This is, of course, a very simple statement of the movie problem. It appears to be very easy. It is not. It is only because of the untold patience, energy and the courage to spend fabulous sums in research that the movie, as we know it today, exists. There are many heartaches in the wake of its progress.

As a result of the study by motion picture experts a group of mathematical rules have been formulated. A few simple facts from movie technique will serve to give you some notion of the monstrous task facing television; a task which Dr. Alfred N. Goldsmith, Chief Engineer of the R.C.A., told me, in Washington, was the greatest task before the radio engineering fraternity today—hence the most interesting.

Standard motion picture film is made to measure sixteen pictures to the foot. In the parlance of the technical cinematographer, each picture is called a "frame." With a projector using standard film and running at normal speed, twenty-four frames are flashed upon the screen each second. If less than twenty-four frames appear, what is known as a "flicker" results, because the time between each two

frames is too long to take full advantage of the sluggishness of action of our eyes. The fewer the frames, the worse the flicker. Increasing the number of frames beyond a certain point does not improve matters much and very pleasing results are obtained from the standard practice of twenty-four frames.

Now, if we are going to have television, we would assume that the simplest way to bring it about would be to apply the same principles that years of experience have made standard in movie practice. In fact, the best way to produce telemovies should be directly from movies. That should be all right; but it doesn't work out just that way.

As we have said, motion pictures, put through a televisior in the Jenkins Laboratory in Washington have been picked up by James Millen in his laboratory in Boston. That is a statement of fact. It is, however, not a complete statement of all the facts. I will try to give you a word picture of the net result.

If, instead of putting his motion picture film through a television transmitter, Dr. Jenkins had passed it through a regular motion picture camera at normal speed, the resulting picture could have been the size and character of any normal motion picture.

The picture received by Mr. Millen, however, was not much larger than an air-mail postage stamp and it was clear enough to be recognized, but no one but the greatest of enthusiasts would have cared to look at it for any length of time. As a picture, it was of interest to few. It portrayed in silhouette a little girl bouncing a large ball. As a photographic portrayal it would not rate very high. As a

movie it would not rate much higher, but as a television experiment it was truly remarkable. And that gets us to the point of view where we are not foolishly expecting perfected marvels at once; where we are not discouraged by the immensity of the task, but where we can appreciate in relatively open-minded fashion, what has been done, what is being done, and what we may reasonably expect to find engineers doing in the immediate future.

So, let us start with the movie film. If we could use it at the transmitter and have it reproduced with anything like fidelity at the receiving end, it would be possible to throw it up to fairly large size and reproduce it in many homes in a manner which would be sufficiently good to warrant its use. The Jenkins Laboratories, Washington, D. C., are attempting to bring this very situation about, and for that reason we may well consider the following exposition of the problem and the manner in which its partial solution has been accomplished. For this highly informative treatise we are indebted to Dr. C. Francis Jenkins and to the *Institute of Radio Engineers* for permission to publish the following lecture, which was read at its convention last month:

IN the art of transmitting pictures electrically, the accepted plan is to synthesize, as well as analyze, the picture surface in a successive consideration of the several elementary areas of the surface.

For example, if the picture surface is divided into 48 horizontal bands, each of these bands is assumed to be divided into 48 elementary areas, making 2304 elementary areas for the whole picture surface. If the complete reception of the picture takes five minutes, obviously a recording surface must be employed; for example, a photographic film or plate, an

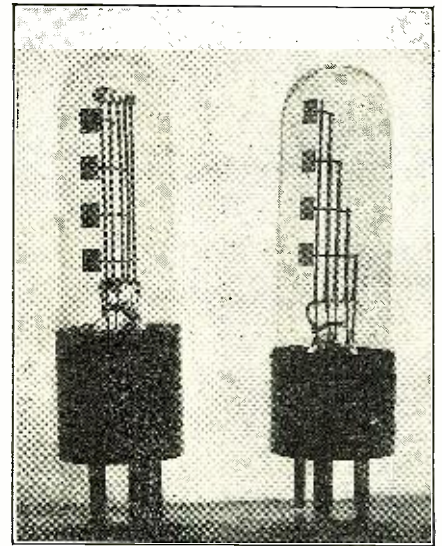

JENKINS MULTIPLE-CATHODE LAMPS
USED IN DRUM RADIOVISOR

electrolytic paper, or a plain piece of paper on which ink or other coloring means is used.

However, if the speed of completing each picture is reduced to 1/15th of a second, and repeated every 15th of a second, no recording surface is needed, for, because of persistence of vision, the picture can be assembled directly on the eye, and "radiovision," "radiomovies," or television becomes an accomplished fact.

This is the method, fully described as long ago as 1884, which has been employed by all workers to the present time.

The picture scanning mechanism employed in this 1884 device, and by others since, consists of a rotatable disk with 48 miniature apertures therein, the diameter of each aperture being about 1/48th the length of the scanned line, or 1/2304th part of the whole scanned area, and conveniently termed the "elementary area" of the picture surface.

As each aperture in the disk lies on its particular radius, of 48 such radii, and each aperture located approximately its diameter nearer than its neighbor to the axis of the disk, namely, in a spiral, it will readily be seen that when the disk is rotated the locus of each aperture in succession produces a linear scanning of the whole picture area.

Because this scanning disk limits the illumination to the light which can pass through a single one of these tiny holes, a powerful source of light is required for adequate lighting, just as is required in a pin-hole camera, with which it is comparable.

As such a powerful light was not available in my laboratory, I put a lens over each aperture in the disk, making the aperture as large as the working area of the lens, and a comparatively small light-source, e.g., an automobile headlight lamp, was then quite adequate. The necessary elementary area was attained by focusing the light source into a pin-point on the subject or surface to be scanned.

This lens-disk was shown in some of the illustrations used with a descriptive article previously published.*

The same lens-disk was also used in a

* C. Francis Jenkins, RADIO NEWS, December, 1923.

JENKINS 7-INCH DRUM SCANNER AND
36-INCH DISC SCANNER MAKE THE
SAME SIZE PICTURE

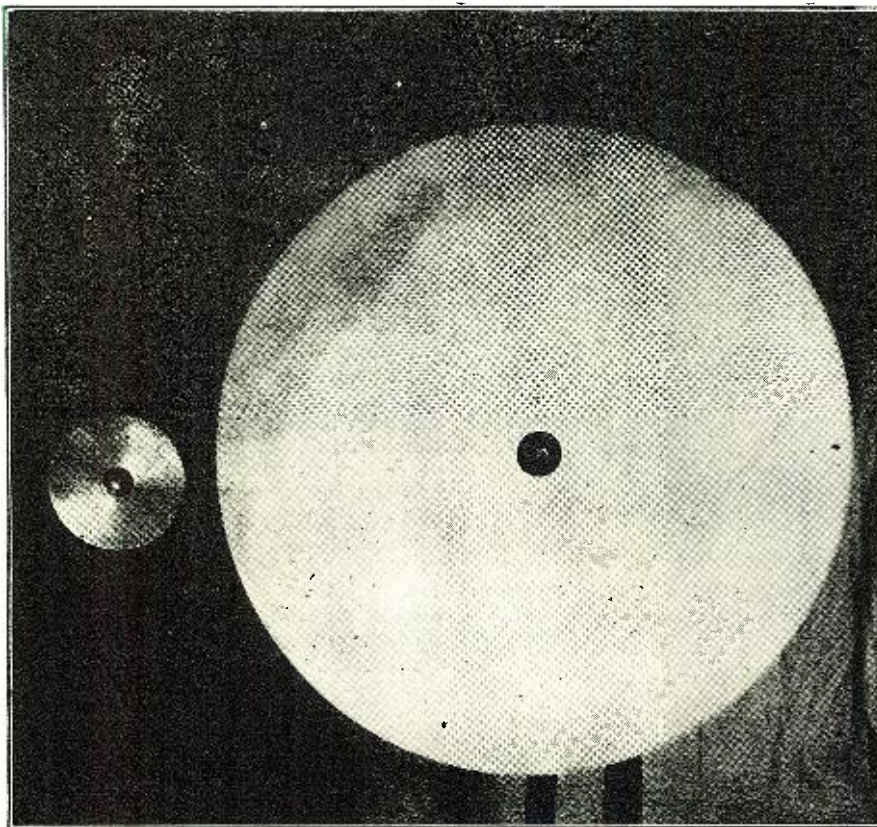

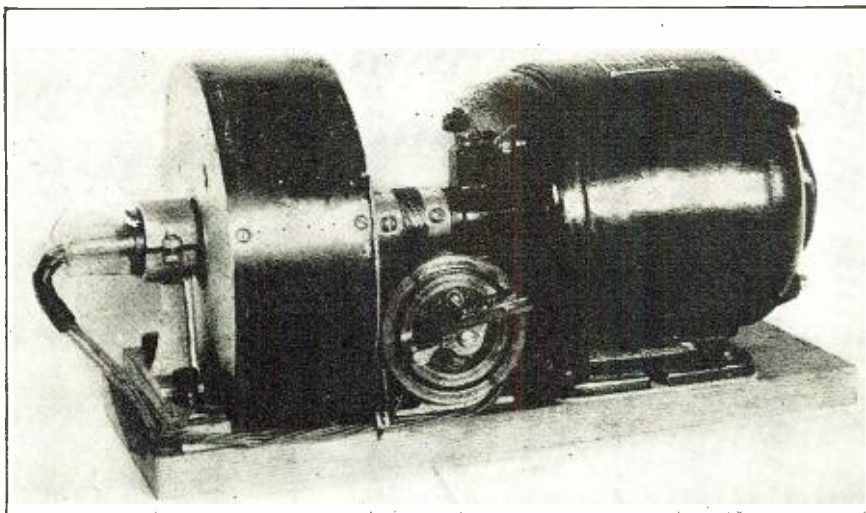

THE CHASSIS OR MECHANISM FOR THE JENKINS RADIOVISOR (DRUM-TYPE SCANNER)

public demonstration of radiovision and radiomovies on June 13, 1925, broadcast from Navy Station, NOF, Anacostia, and received in my laboratory in Washington, in the presence of Navy Secretary Wilbur; Acting Secretary Judge Davis, Commerce Department; Director Dr. George M. Burgess, Bureau of Standards, and many other government officials.

But the disk scanner, whether apertured disk or lens disk, has physical limitations in practical application which seem, as at present employed, not to permit very much development.

In the scanning disk, the minimum separation of the apertures determines the width of the picture; and as the picture is approximately square, this aperture separation also determines the offset of the ends of the spiral.

A disk 36 in. in diameter is required, therefore, for a picture 2 in. square. A 4 in. picture would require a disk of 6 ft. diameter—a rather impractical proposition in apparatus for home entertainment, even if it were possible to get power enough out of the house wiring to bring the disk quickly up to the proper speed.

To lay the apertures out in a multiple turn spiral does not help, for the picture size is still determined by the separation of the last two apertures nearest the axis of the disk. And such an arrangement requires a rotating mask or other complications which more than offset any theoretical advantage.

For a source of light to make up the picture in an apertured disk receiver, it is usual to provide a glowing plate cathode in a neon gas lamp.

This glowing cathode plate is looked at through the flying apertures of the rotating disk, the incoming radio signals modulating the cathode glow to build up the picture. The cathode plate for a 2 in. picture must, to provide a marginal latitude, be somewhat larger than the picture, say, 2½ in. square.

To light this 2½ in. cathode plate requires from 90 to 110 milliamperes of current, necessitating special amplification of currents obtainable from the plate of the last amplifier tube of usual radio sets.

And so the proposition as a whole does not look very enticing, and it was for

these reasons that I never employed the elementary-area apertured scanning disk. The lens-disk was the nearest I ever came to it.

The drum method, however, is much more promising, for a cylinder, or drum, is free from many of the limitations of the disk, and has some very meritorious features of its own.

To get a mental picture of the drum, structurally, let us image a hollow cylinder 7 in. in diameter, 3 in. in length, and 1/16 in. wall; with a hub, hollow for the length of the drum, and about 1½ in. inside diameter. The hub has an extension outside the drum which slips onto the ½ in. shaft of a small motor.

There are 48 scanning apertures punched or drilled in the peripheral wall of the drum, each aperture of elementary area, say 1/24th in. diameter. The apertures are arranged in four helical turns and spaced 2 in. apart circumferentially, the turns being ½ in. apart.

Inside the drum-hub a 4-target cathode-glow neon lamp, 1½ in. in diameter, is held by a clamp mounted on the motor platform at the open end of the drum, preferably.

Between the lamp and the periphery of the drum are tiny quartz rods, each rod ending under its particular minute aperture in the drum surface.

A quartz rod has a peculiar property, in that light flows through it as water flows through a pipe. That is, the use of

quartz rods may be thought of as avoiding the light loss due to the inverse square law.

One of the cathode targets is located under each of the rows of quartz rods, and they are lighted in succession through a 4-segment commutator, by current from the plate of the last tube of the radio receiver-amplifier.

Because the movement of the inner ends of the rods is so short, these cathode targets need be only about ⅛ by 3/16 in. in size, or, for ample latitude in setting the lamp, say, 3/16 by ¼ in.

Such small size targets obviously require only a very small amount of current compared with the current required for the 2½ in. square cathode plate of a disk scanned picture; say, 3 to 5 milliamperes. The light-modulation of these small cathode targets seems to be just as easily done, if not more easily, than a large plate.

The quartz rods are employed to avoid the light-loss due to the inverse square law. And to discover how effective they are, one has but to remove the rods, for no picture can be seen without them, though every other condition remains the same.

The miniature cathode targets lie about 3/16th in. from the inner end of the quartz rods, which at this point have relatively small movement. The size of the picture, however, is limited only by the arcuate distance from the outer end of one rod to the outer end of the next. But as the light at the outer end, that is, the picture end, of the rods is just as intense as it is within 3/16th in. of the light source itself, we get an acceptably lighted picture, for there is no loss of light in its travel along the quartz rods.

Neither does the drum scanner have another of the limitations of the disk. That is, the scanning apertures in the drum may be arranged in a plurality of helical turns without in any way changing the spacing between any of the apertures.

A drum 7 in. in diameter with scanning apertures in four helical turns gives a 2 in. picture. Magnified, the picture appears about 6 in. square; and in daily use it has been found that five or six people, the whole family, can very conveniently enjoy the story told in the moving picture.

The same size drum with six helical turns gives a 3 in. picture, unmagnified, which is more than twice the area of any picture possible with a 36 in. disk.

(Continued on page 170)

JENKINS DRUM RADIOVISOR SHOWING QUARTZ RODS TO CONSERVE LIGHT BY OVERCOMING THE INVERSE SQUARE LAW

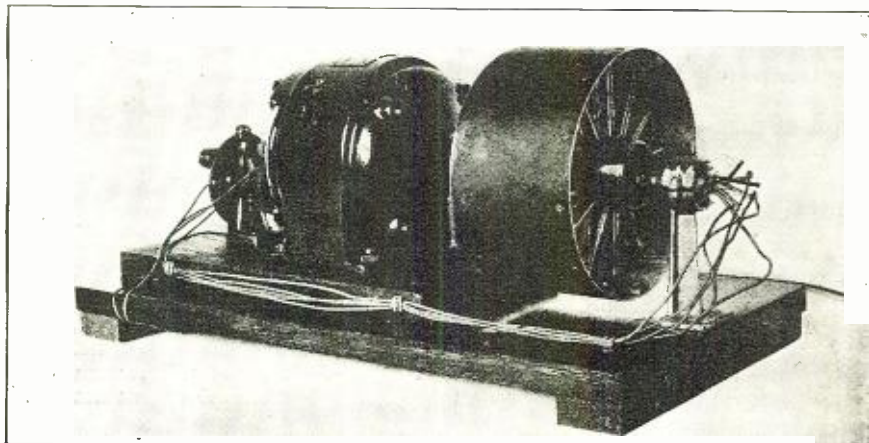

Putting the Portables Through Their Paces

*Further Experience With the Portable Transmitter
and Multiwave Receiver Described Last Month*

BY WILLIAM H. WENSTROM

Lieut. U. S. Army

THIS rather imposing title covers several aims. Under it we narrate some further field tests with the portable transmitter and receiver described in the last issue (*RADIO NEWS*, July, page 33), and explore more thoroughly some of the fascinating angles of portable work, even lapsing occasionally into reminiscence.

Further Tests

On a recent warm night we took the receiver up on the roof of a building, about 250 feet above the Hudson River, to see what could be done with the broadcast coil. To give the 30-foot antenna and the two diminutive 199 tubes at least a fighting chance, we naturally waited until the New York broadcasters were supposedly off the air. But the first thing we heard was WEAF, relaying the Fort Worth celebration in honor of the endurance fliers, Robbins and Kelly—interesting enough to bear listening to for a time, while Saturn and then a copper moon rose slowly over the Garrison hills. A light fog clung close to the river and its banks, the center of a high-pressure area

ROWING OUT ON THE HUDSON READY
TO COMMENCE THE TESTS

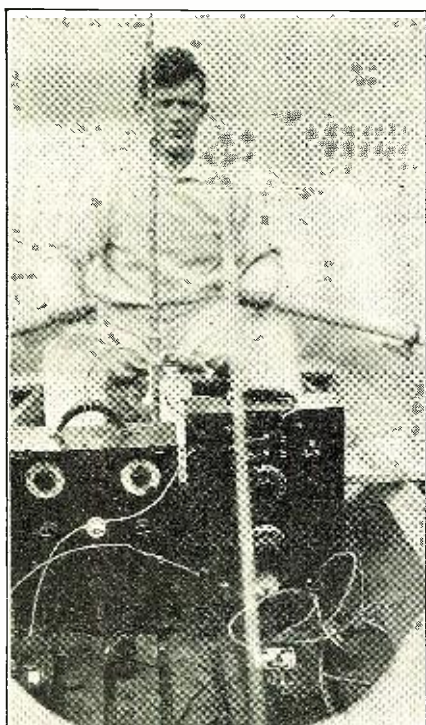

was approaching—all in all it was a good radio night. The first "outside" station to be logged was WJR at Detroit, followed in a few minutes by WENR and WCVN at Chicago, and WLW at Cincinnati. These were all at loud headphone volume. Then came WPNJ at Milwaukee, fainter but distinct. An elusive voice and strain of music turned out to be, after some trying, WBAP at Fort Worth. By straining ears and patience, not to say conscience, we might have reached the coast; but Fort Worth seemed enough—we took the set downstairs, leaving the night to Saturn and the moon.

City, about 150 miles away. On the 80-meter coil several amateurs in the 1st and 8th districts—New England and the eastern mid-west—were copied. This was up to expectations, as the 80-meter band never is very populous in the daytime.

With the 40-meter coil there was some difficulty in tuning, as the wind was rising and swinging to eastward, driving the waves around the bend in the river. The

AN AERIAL VIEW OF WEST POINT SHOWING
THE TERRAIN IN WHICH THE TESTS
WERE MADE

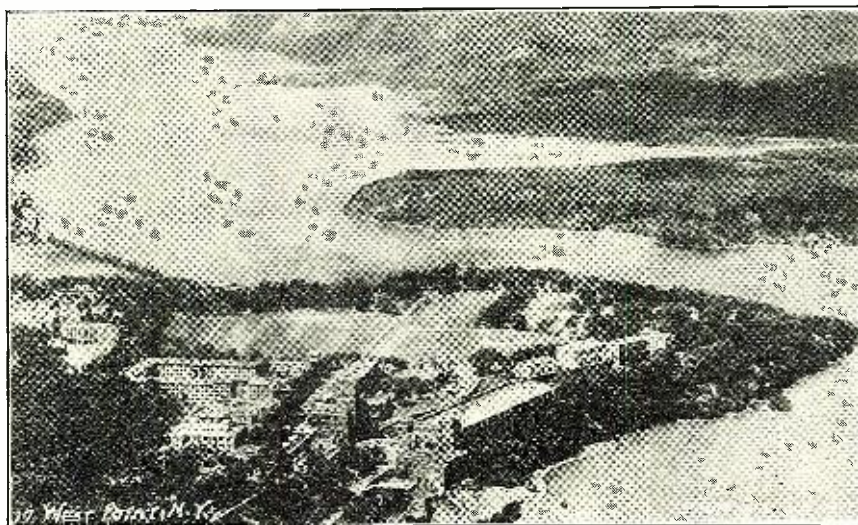

On a morning test from the same location with the 111-D coil, plenty of ships came in around 600 meters, calling each other and shore stations, sending position reports and traffic. Up on 1,000 meters the double dash signal of Fire Island Lightship whined out continually, telling of fog on the Atlantic south of Long Island.

Another test was made on the Hudson. We set up the receiver in a 12-foot rowboat, with the umbrella (diagrammed in last issue) and a copper ground plate for contact with the water, and drifted around with the wind and current for an hour or two, picking up plenty of stations and a healthy sunburn. The time was around 5 P. M., broad daylight, of course, and the antenna was quite small. On the broadcast coil WEAF, WOR, WJZ, WABC, WODA and WAAT, all around 50 miles distant, were clearly audible. Then WPG came through with loud headphone volume from Atlantic

detector circuit was steady enough, but it was difficult to tune the dials accurately and stay in the boat at the same time. However, scores of amateurs were heard in the narrow 40-meter band, as well as many commercial stations outside it. Finally, as the climax of this test, we logged the crystal-clear whistling signal of 9EK, cutting through the 40-meter bedlam all the way from Madison, Wisconsin. Both stages of audio were used in these water tests.

Of course the receiver was designed for use with an antenna, but in the 40- and 80-meter bands much can be done with the set box alone, using only the self-contained wiring as a pick-up. As a test of this we took the set box up on the aforementioned roof one evening, and perched it somewhat precariously on a stone cornice. On the 80-meter coil amateurs came through from the 1st, 8th and 3rd (Middle Atlantic States) districts, and some amateur phones on 85 meters were

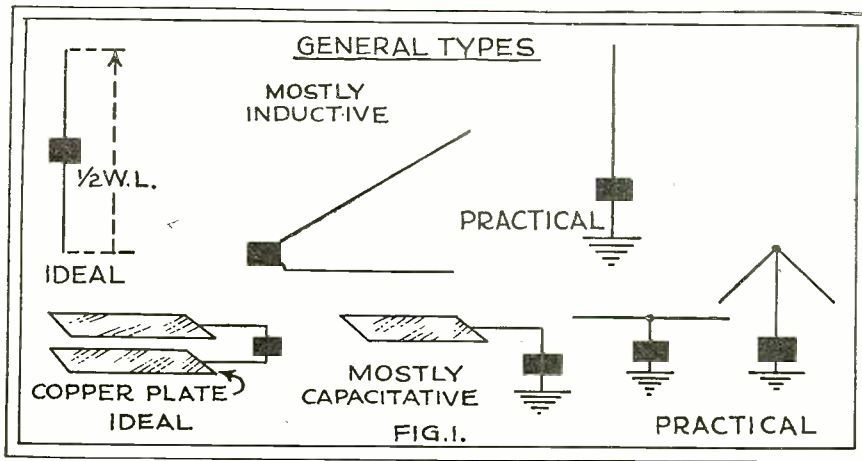

car with another portable set, we drove over a sharp rise towards the transmitter three or four miles distant. The signals increased greatly at the brow of the rise; the effect was like coming suddenly around the corner from a quiet street into the noise of a thoroughfare, or like stepping into the beam of a searchlight. We noticed, also, that the signals followed street-car lines, doubtless on the wired wireless principle. In this field alone there is plenty of opportunity for research. Of course the big stations have mapped their fields, but our knowledge of wave propagation along the ground, or anywhere else, is very far from complete.

The transmitter, also, has had its share of activity. On a boat test around West

heard but not located. On the 40-meter coil swarms of amateurs could be heard, among them 1AOI of New England, 3ON of the Middle Atlantic States, and 9CRJ of the Middle West. And this was with the set box alone, no antenna or ground, using a 199 detector and one stage of audio!

On another evening we did some interesting work in the car with a ten-foot wire stretched over the top, from radiator cap to spare tire, for antenna. On the broadcast coil WABC, WJZ, WOR and WEAF of the New York area came through faintly; WPG at Atlantic City somewhat better. Ignition noise was worse than on the previous car tests described in the last issue, because the very small antenna did not pick up a signal strong enough to be heard well through it. With the motor idling and at speeds up to 10 or 15 miles per hour one hears a series of clicks, which merge into a

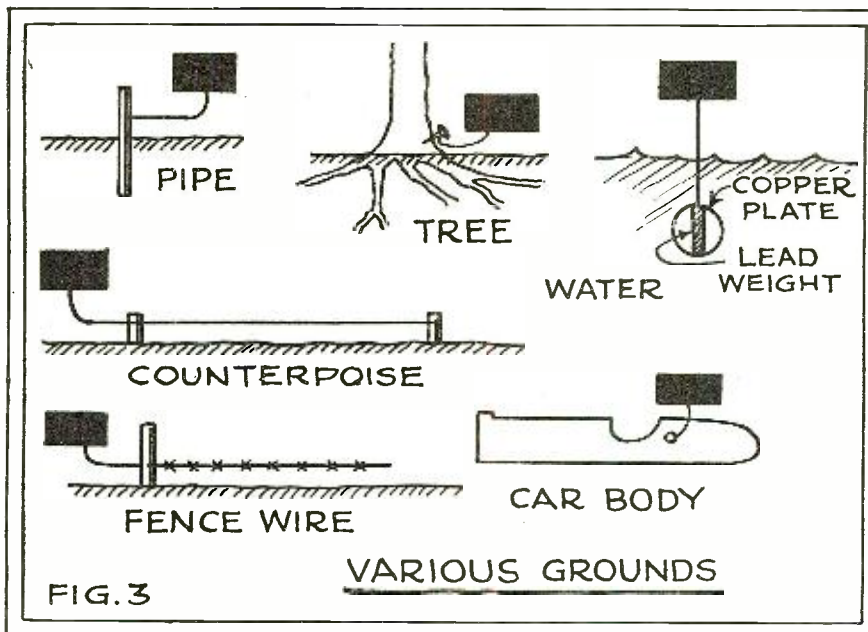
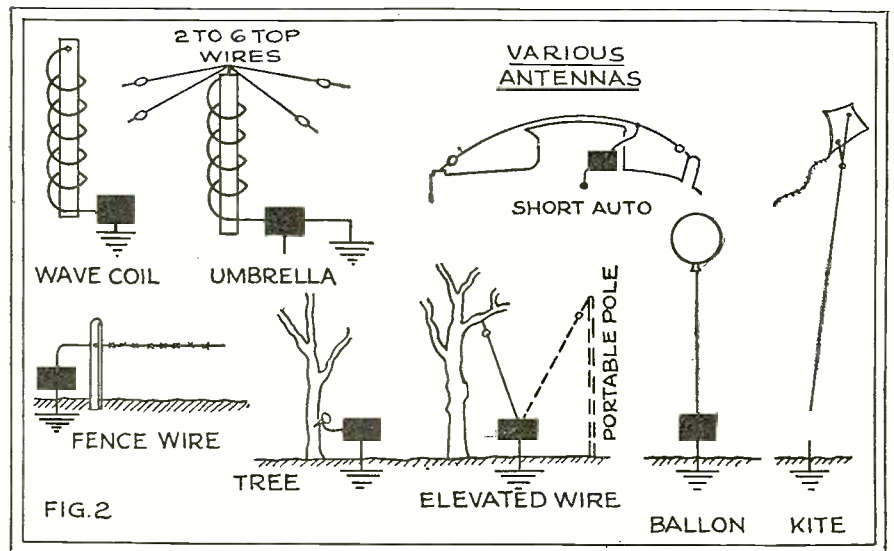

Point we kept a regular schedule of transmissions with two listeners, Lieuts. Bulene and Shingler, at West Point. The umbrella antenna was used with a copper plate ground. Lieut. Corput and the author manned the rowboat, which moved up the river with as much majesty as such a craft can muster when it has to keep out of the way of large and fast river steamers. The passengers crowded to the rails at sight of this grotesque cockleshell desecrating the Revolutionary scenery. At Cold Spring, two miles above West Point, we switched on the transmitter and began describing the scenery in the best McNamee manner, meanwhile thinking "Two miles—two watts input with phone—it won't work."

Then we dropped down the river to Constitution Island, one mile from the receiver, and continued our discourse. Dropping further downstream, we rounded the bend and came within sight of the building where the receiver was, still talk-

steady roar at about 20 miles per hour. The signal-noise ratio was somewhat improved by using a short wire as counterpoise instead of the car body.

We drove over the Storm King Highway, which winds along the mountainside at varying elevations above the Hudson, listening to the carrier of WABC. The signal strength usually increased on the

heights and decreased in the hollows, though this was not an absolute rule. Signals also increased whenever the road led out over the river in rounding a mountain shoulder. These effects are much more pronounced close to a transmitter, before the sky wave has begun to come down in any great strength. A few years ago in El Paso, when making tests in a

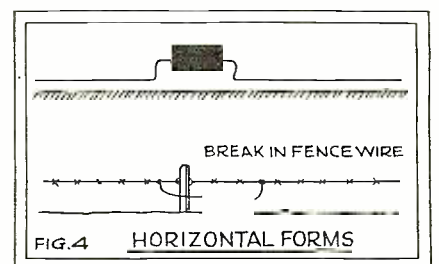

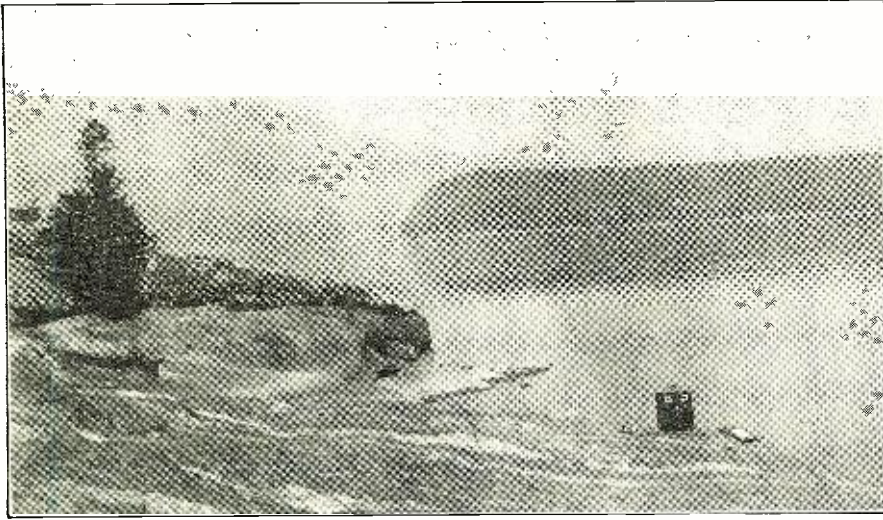

A TEMPORARY SET-UP ON THE ROCKS AT THE EDGE OF THE HUDSON

ing continuously into the unimpressed microphone. As we came opposite the building, the boat a quarter mile out in the river, the impression grew that we had been talking to ourselves, or at most to whatever fishes had happened along. We asked the mike: "If you hear this, please come out on the roof, and wig-wag O. K." We paused, unbelieving. Then a small figure appeared on the roof; it was signalling with a handkerchief "OK—all OK." We were ready to call the test a success. We found later that every word had been understood.

On another day we tried out the transmitter in the car with that ridiculously small antenna—the 10-foot wire over the top. With Maj. Moreno at West Point and Lieut. Bullene at Highland Falls as listeners, we drove up to Lusk Reservoir and switched on. Again we fell back on the radio announcer's standby, describing scenery. The West Point receiver was three-fourths of a mile distant and the Highland Falls one one and a half miles away, and both heard us. Signal strength was none too good at Highland Falls, but better than expected with the small antenna. Then we started the car and drove slowly along the road, still talking. Several casual passers-by appeared quite dumbfounded to see an apparent lunatic sitting in a car talking to himself. During the winding drive down the hill towards the West Point receiver, it again seemed impossible that anyone could be really hearing us. Yet when we passed the house, there was Maj. Moreno out in front. He had heard every word, and had further noted signal strength changes that corresponded with the undulating terrain over which we had come.

Operating Notes

The receiver's performance depends to a large extent on the detector tube. As the average 199 is none too good in this respect, it is well to check over a number of tubes, selecting the best detector by trial. The potentiometer allows some control of the tube's oscillating characteristics by fixing the grid bias. With the potentiometer turned slightly to the negative side, the detector should go into oscillation with a smooth hiss, and the set is most sensitive to weak code or phone. With the potentiometer turned positive,

operator's license must be obtained by making application to the nearest Supervisor of Radio and taking an examination. In addition, a station license must be applied for, but as an ordinary station license is good for use in one location only, this must be a portable station license, good anywhere in the radio district. Strictly speaking, a portable amateur radio transmitter cannot be used on a boat, as this class of service is in general covered by the limited commercial license. However, the chances are that an application for a limited commercial license on yacht "Pansy, 12-foot rowboat at present located on waters of Long Pond," would scarcely be taken seriously by the Supervisor.

One detail of the transmitter construction needs emphasis. While the coils look somewhat flimsy in the photograph, in reality they are as solid as rock, and must be so to keep the calibration constant. The "dope" is made from some

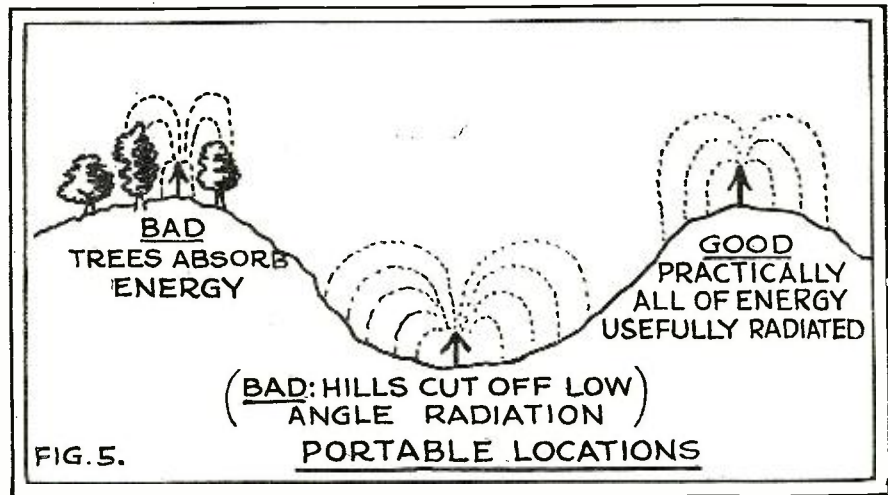

oscillation occurs with a sharp plop; this position is best for loud code or phone. The most sensitive adjustment of the tickler condenser, of course, is as near as possible to the oscillation point—below it for phone, and above it for code.

We might mention here two uses of the receiver in addition to ordinary reception. Most campers and boatmen have been caught in summer thunder squalls, usually with inconvenience and sometimes with danger. Such a squall may approach almost unseen behind hills or cloud formations, but its approach can be sensed from the heavy crashing static, growing more frequent, which precedes it. With a little practice in listening and observing, one can learn a good deal about thunderstorm progress, particularly by referring to a good meteorology text. The field is little explored, and holds some interesting possibilities.

Yachtsmen who venture out on the broad ocean will find the 111-D coil very useful. Ships can be copied, and some estimate of surrounding ocean conditions can be made from their reports. Radio beacons, listed on the Government charts, will be heard in foggy weather, and their relative loudness will give some indication of the boat's position.

Turning now to the transmitter, we might add some further information on license requirements. First, an amateur

BELOW, A GOOD LOCATION AMONG THE WOODS, THE TREES OFFERING A MEANS FOR STRINGING THE PICK-UP WIRE

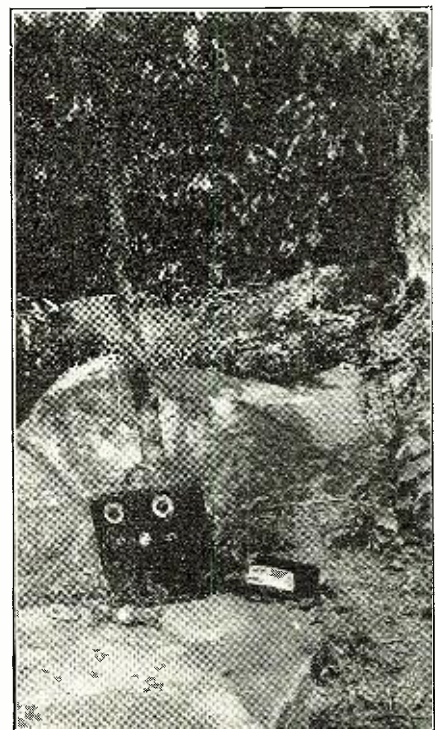

form of celluloid, such as photograph negatives, dissolved in acetone. Both the form and the coils are given a heavy coating.

The transmitter-receiver arrangements will be found very convenient for two-way communication. To change from "send" to "receive," after the set-up has once been made, one need only throw two switches, an operation requiring perhaps two seconds. During the Long Island tests we worked with Garden City and Mitchel Field, both over a mile distant from the car set-up, first one and then the other. In fact, all three stations engaged in a more or less indiscriminate conversation, and the portable station had no difficulty in keeping up with the two fixed ones. For portable two-way work, it is best at first to bring all stations close together, within a few yards, and calibrate each receiver on each transmitter so that in long range work time will not be wasted hunting all over the band for desired signals. The times of operation, or schedules, must be determined beforehand and rigidly adhered to.

Antennas and Locations

To cover thoroughly the subject of antennas no less than a book would be required, but some of the essentials can be indicated here. Needless to say, antenna design is very important in portable work. Outside of such special types as loops, wave antennas and reflectors, the ideal antenna, as indicated in the diagram, would be a single wire one-half wave length long and interrupted at its center by the radio set, or possibly two large copper plates with the set connected between them. We can rarely put these ideals into practice in portable work; we must employ close approximations of the ideals—for transmitting, as close as possible. Receiving sets will work on almost anything,

A VIEW SHOWING OPERATING CONDITIONS IN A 12-FOOT ROWBOAT WITH AN UMBRELLA TYPE ANTENNA

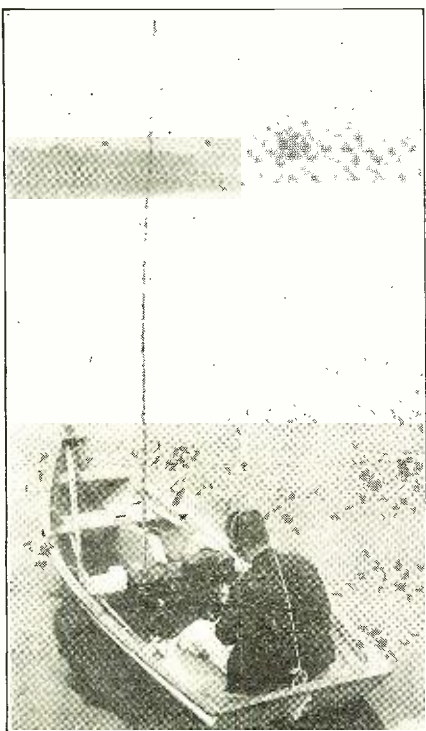

TRANSMITTER AND RECEIVER SET UP ON THE CORNER OF ONE OF THE BUILDINGS AT WEST POINT

depending on the sensitivity required. The only trouble likely to be encountered with receiving antennas is a failure of the set to oscillate when the antenna fundamental is too near the desired frequency, and this trouble is easily cured by connecting a series condenser in the circuit. But the transmitter refuses to radiate efficiently from some of the weird combinations that delight the receiver. We must use either an elevated single wire about 1/4 wavelength long with some form of counterpoise or good ground underneath it; or we must approximate the plates of a condenser, using a short overhead wire or mesh and an excellent ground or a quite massive counterpoise (such as a car body) beneath it.

The diagrams (Figs. 1 to 4) show some of the practical pick-up forms. The umbrella and short auto wire follow the condenser type. The "wave coil" gets more inductance into a limited height, as 20 to 40 feet of wire is wound spirally around a 12-foot pole of light bamboo. (The coil may also be wound on a large pasteboard cylinder, but this is far from portable.) All three of these antennas are compromises between efficiency on one hand, and compactness and convenience on the other. When used with the transmitter, they require a loading coil of about fifteen or twenty turns on a 2 1/2-inch form before the antenna circuit will tune up to 85 meters.

Grounds for either transmitting or receiving must be of low resistance. A long metal pipe may be driven into damp soil on land. On the water the problem is easier—a clean copper plate weighted down by lead will do very well. If no good ground can be had we use a counterpoise in its place—a wire insulated from the ground—a car body—a sheet of metal or screening. For receiving a fence wire may do, or even a nail driven into a tree or shrub. The receiving antenna proper may be almost anything—a light wire carried by a balloon or kite, a fence wire, a tree. Finally, there are the horizontal forms of antenna—two insulated wires laid along the ground in opposite directions, or a fence wire interrupted by the set.

We mentioned last month the importance of location in portable work, an im-

portance which in the case of transmitters can scarcely be exaggerated. We must remember that we are dealing, in effect, with light waves of very low frequency. If we wished to signal with a searchlight we should not put it down in a hollow, surrounded by obstructions. The same principles apply, with less rigidity, to a radio transmitter. Even at broadcast frequencies close to the transmitter cast appreciable "shadows"; at 80 meters these effects are more noticeable; at 5 meters and less the waves behave almost like light. Not only should the transmitter be set up, when possible, on high, unobstructed ground with a "clear shot" towards the receiver, but it should be kept as far as possible from elevated wires, trees, foliage and other conductors, good or bad, which may absorb a large part of the outgoing energy. Favorable and unfavorable locations in a given terrain are shown in the diagram.

An interesting case in point occurred a few years ago near El Paso. The lower Rio Grande valley was flooded, troops were rushed from Fort Bliss thirty miles to the stricken area, and my platoon handled the radio communication. The field radio sent with the troops late in the afternoon having failed to report in about 10 P. M. as expected, the Radio Sergeant and I drove hurriedly down the valley to see what was wrong. We found that the first set-up had been made in the only place then available—a railroad cut surrounded by hillocks and trees. After we had moved the set to a more open location, the front yard of a ranch house, communication was established with Fort Bliss. Later in the day, when rising water surrounded the transmitter on three sides, its signals actually became louder, probably due to complete surface reflection from the water.

This third factor in portable transmitter efficiency, ground conductivity, is not very well understood even now. We know that a highly conductive surface is to be preferred—broadcast transmitters are often built on salt marshes—but there are still many obscure vagaries of the terrain that are difficult to explain. There was a point in the desert sand two or three miles east of Fort Bliss from which our transmitters could never work successfully, though they were clearly heard from locations nearer or locations beyond it. There

(Continued on page 171)

The Analogy Between Radio and the Talking Pictures

BY CARL DREHER

Chief Engineer, R. C. A. Photophones, Inc.

IF we interpret the word "radio" in the strict sense of communication through space by means of high frequency oscillations, there is none of it in the talkies, or, as one moving picture trade paper stiltedly refers to them, "the audients." The connection is one of development and underlying principles, and is reflected in certain similarities in the apparatus and the technique of employing it. The best approach to understanding what a thing is, is to learn how it got that way—the historical method. By tracing the story of the development of the radio and audio

Instead of merely projecting trains of radio frequency oscillations into space and interpreting them by means of a telegraphic code, it became possible to modulate radio frequency oscillations, generated by one vacuum tube, through the action of another vacuum tube on the first. Likewise voice currents on a telephone line could be amplified at intervals, thus providing one of the essential devices of long distance telephony. Radio broadcasting is simply a special application of radio telephony. The audio frequency amplifier could similarly be used to strengthen the sounds of speech; this application gave rise to the public address system. A public address system is an enlarged version of the audio amplifier portion of a radio receiver; the two belong to the same family, like a tiger and a cat, with merely the differences arising from the respective sizes. Or, considered from the transmitting angle, a public address system coincides generally with the audio section of a broadcast transmitter. These relationships are shown pictorially in Fig. 3, with arrows indicating the general trend of development, and shading within the blocks denoting similarity of design and function of the apparatus. The last step, it will be noted, is the wedding of the public address mechanism with the art of motion picture projection—and a very dissonant marriage it has frequently proved.

velopment, leaving particulars for later discussion.

The five parts of Fig. 4 are presented for a quantitative comparison of radio broadcast transmission and reception with sound motion picture recording and reproduction. Starting with Fig. 4-A, we note a radio broadcast transmission system in its essential features. Energy levels are given in telephonic transmission units, also known as decibels, abbreviated TU and DB. These units may be

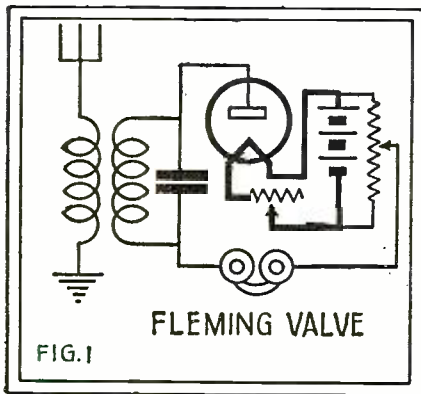

arts, we can reach a better comprehension of their interrelations, similarities, and differences—for there are differences as well as identities.

Radio began as an effort to penetrate space. For that purpose high frequency oscillations were required. Their order was several hundred thousand or several million cycles a second—entirely inaudible frequencies, released in audible bunches several thousand times a second. In trying to solve the problem of rectifying these radio frequency impulses, Fleming evolved his valve detector, the circuit of which is shown in Fig. 1. De Forest added the grid (Fig. 2), a control element which enabled the valve to function as an oscillator and amplifier as well as a rectifier. Then, as is usual in technological development, improvements were added which in the aggregate are probably as important as the original inventions. The consequence was that by 1918 industry had at its command reliable forms of three-electrode tubes which would oscillate at any frequency within exceedingly wide limits, follow faithfully practically any wave form, and perform great feats of amplification at audio or radio frequency.

Radio telephony thus became feasible.

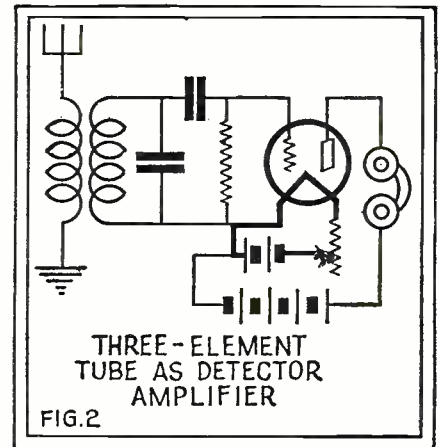

translated into terms of voltage or energy amplification by use of the formulas given below:

$$TU = 20 \log_{10} \frac{E_1}{E_2}$$

E_1 and E_2 are two voltages, as the output and input voltages of an amplifier. The formula holds only for equal input and output impedances, and no phase change; if the impedances are different, a correction is required. In terms of energy, however, the formula holds regardless of impedance values:

$$TU = 10 \log_{10} \frac{P_1}{P_2}$$

In this case P_1 and P_2 are the two power or energy values. The reference or zero level is assumed to be 0.010 watt, which is approximately the output of a standard desk transmitter. On this basis we start in 4-A with a condenser microphone, which delivers electrical energy at a level of about -60 TU. A carbon transmitter is more sensitive, and would deliver an output of perhaps -40 TU, so that two stages of amplification less would be required. Following the condenser transmitter there is an audio amplifier system with probably five stages in all; this is assumed to contribute an amplification of

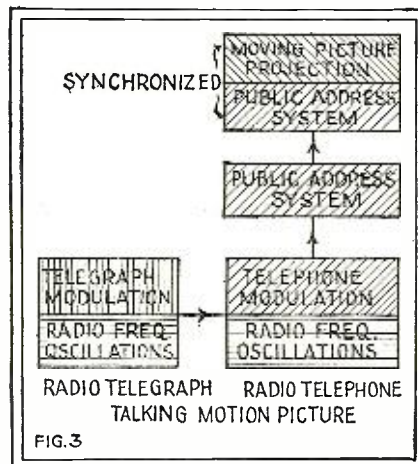

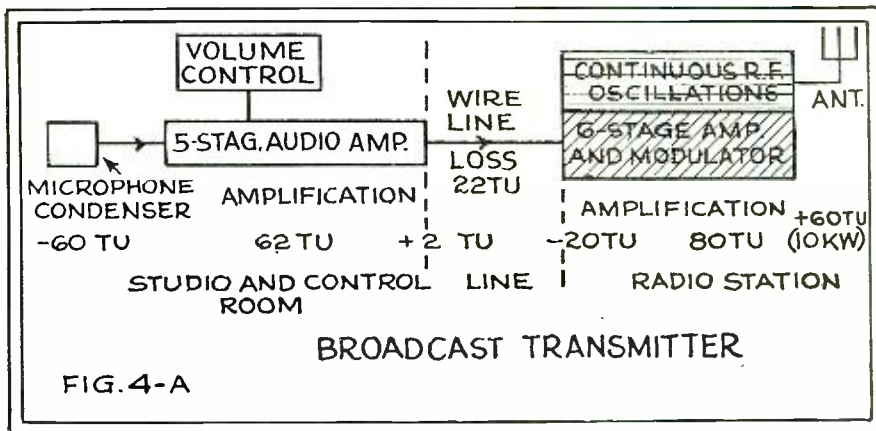

FIG. 4-A

62 TU, producing an output of +2 TU. A volume control is associated with the amplifier to vary the amplification as required. All this equipment is in the studio and control room of the broadcasting station. We then assume a wire line between the studio and the radio broadcasting station, with a loss of 22 TU, part of which is probably supplied by artificial attenuation. The audio system picks it up at -20 TU, and, if the station is a high power outfit, may amplify another 80 TU, resulting in a level of +60 TU, corresponding to 10 kw. of audio energy for modulation purposes. This is applied to the radio frequency generating system and impresses the characteristics of speech or music on the radio frequency energy in the antenna system.

In Fig. 4-B the subsequent course of this energy through the broadcast receiver is shown. It starts at a low level again, -70 TU, which corresponds to a fair signal from a moderately distant station. Not much of the original radiated energy

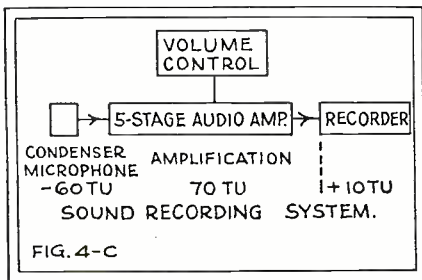

FIG. 4-C

reaches the individual listener, that being the nature of the medium. In this case the drop is from +60 to -70 TU, a difference of 130 TU, which you can visualize as a ratio by writing 13 zeroes after the numeral 1. The order of magnitude of the received energy, it will be noted, is less than that originally issuing from the microphone at the broadcasting studio, in the assumed example; it may be still less or much greater, depending on the power of the transmitter, the distance of the receiver, the electrical height of the aerials, and the condition of the intervening space channel. Anyway, amplification is again called for. In our example we assume 50 TU at radio frequency, with a volume control, and then another 30 TU in the audio amplifier. The speaker accordingly gets 100 milliwatts of audio energy, corresponding to a level of +10 TU. Of course with modern output

tubes of the 250 size, the energy delivered to the speaker might be much greater, say +20 TU, or 1 watt, but +10 is a fair loud speaker signal for home use.

We may now proceed, in Fig. 4-C, to a comparison of the above conditions with sound movie recording. As in the case of the broadcast transmitter, we start with the microphone. While in the broadcast station it may be either a carbon transmitter or a condenser, in the motion picture studio it is almost certainly a condenser, because of the lower ground noise level, and because in movie work it is advantageous to be able to tilt the microphone, which is not feasible with carbon instruments. About the same amount of amplification follows as in the control room of the broadcast station, perhaps 70 TU, delivering +10 TU to the recorder. This is somewhat higher than the output of the broadcast control room, because the latter is limited by the cross-talk worries of the telephone company to +2 or +6 TU. The recorder may require more than +10 TU, so that the recording amplifier is built to deliver considerably more. As previously, the voltage amplification is regulated by a suitable volume control along the audio chain. In general, more output is required for wax recording than for recording on film, since in the latter case it is only necessary to actuate an oscillographic instrument, which then affects a light beam; whereas when a disc is being prepared wax must actually be cut by an electromagnetically actuated tool, and, furthermore, in order to secure a flat frequency characteristic, it is generally advisable to dissipate considerable energy in an absorbing system associated with the wax cutter, to make

the variable load introduced by the wax itself a relatively small part of the total load.

In Fig. 4-D reproduction from a disc record is illustrated. The hard phonograph pressing drives a pick-up with considerable vigor, as is shown by the fact that in an electric phonograph, with a good pick-up, only two stages of audio amplification are required to produce a loud speaker signal. In other words, an output of the order of -15 TU may be expected. This requires, in theatre reproduction, only two stages of voltage amplification, followed by a power stage to handle the requisite output. In our example we assume a total amplification of 48 TU, resulting in +33 TU, or 20 watts of audio energy, delivered to the loud speaker system. This is generally sufficient for a 2,000-seat house. In practice, it may be secured from two sets of 250-tubes in push-pull, each set contributing a little under 10 watts of audio power with the allowable harmonic generation of 5 per cent, and feeding a number of loud speakers.

Finally, in Fig. 4-E, a film reproducing system is shown. The film, with its pick-up mechanism consisting of a constant source of light shining through the sound track and falling with variations proportional to the original sound pick-up onto a photo-electric cell, does not yield

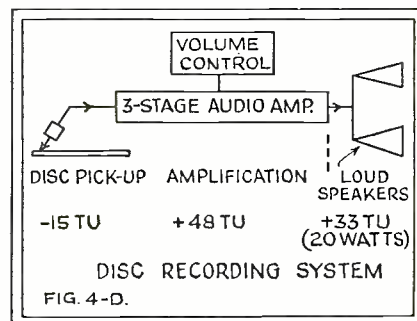

FIG. 4-D.

as much energy as the disc, so that for the same output more amplification is required. Starting at about -35 TU, which is approximately the output of a carbon microphone on moderate speech, amplification to the amount of 68 TU will bring the level up to the same +33 TU as before. This may entail a total of 5 to 6 stages instead of 3.

As in the case of audio amplifiers employed in radio broadcasting, every effort is made in design of sound movie equip-

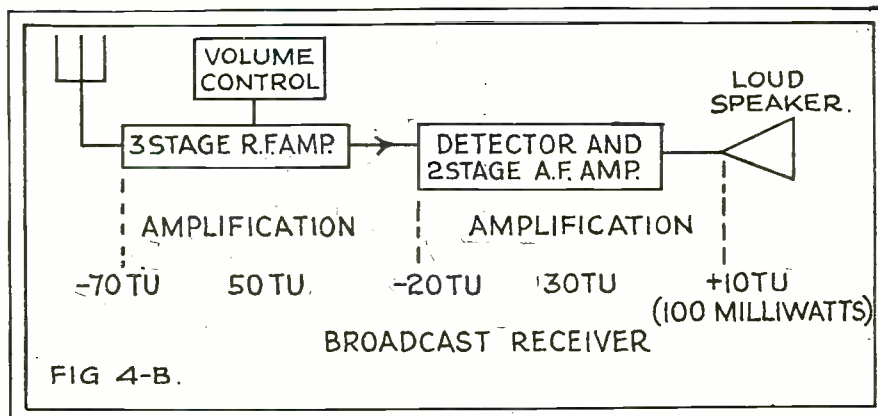
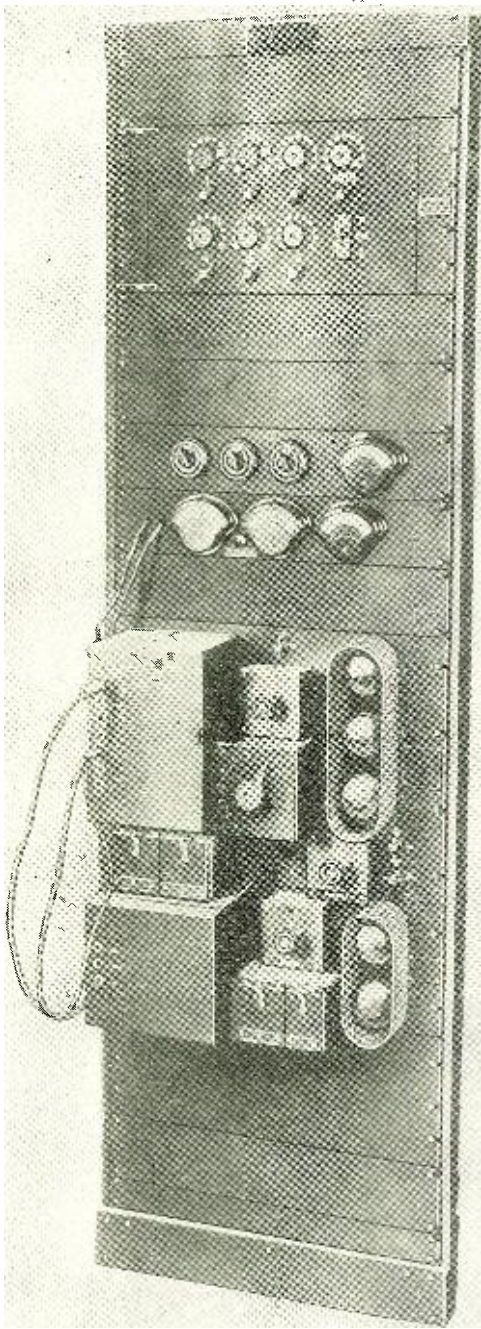

FIG. 4-B.



A TYPICAL AMPLIFIER GROUP—PART OF THE WESTERN ELECTRIC SOUND-PROJECTOR SYSTEM EMPLOYED IN THEATRES

throughout the usual audio range. An input impedance of 200 ohms is provided for a microphone or line connection, while in the output there is a choice between a 6,000-ohm winding for operating a loud speaker or public address system, and a 500-ohm winding for feeding a line. This is a useful general purpose voltage amplifier where only moderate output is required. Normally it is used with an amplification well under the maximum, say 40 to 50 TU. In this condition it is capable of bringing up the output level of a high quality, insensitive microphone, to zero level.

Such an amplifier as that described differs from the audio amplifier of a broadcast receiver mainly in that the latter has one stage less, and probably lacks a high- μ tube, so that the amplification is less, a maximum of perhaps 30 TU being available. An audio amplifier like the Western Electric 17-B, schematically illustrated in Fig. 6, is used in broadcast and sound movie work where less amplification than the 8-B affords is sufficient for the purpose. This instrument is more closely similar to the audio section of radio receivers, since the same two stages are available, although the 17-B uses a high- μ tube in the first stage. A gain control is provided, as in the 8-B, while in broadcast receivers the gain is usually controlled at radio frequency and the audio amplification is a fixed quantity. In flatness of response with regard to frequency such professional amplifiers as those described are

not markedly better than the audio units of high-quality broadcast receivers. Returning to the comparison between the audio system of broadcast transmission and the equipment employed in

ment to secure a flat frequency characteristic. In many instances the same amplifiers are used. The Electrical Research Products system, for example, uses the 8-B or 8-C amplifier as the principal voltage amplifying element in wax and film recording, in theatre reproduction, in public address systems, and in broadcast stations as a microphone amplifier. The circuit of this ubiquitous piece of equipment, somewhat simplified, is shown in Fig. 5. There are three tubes, the first affording an amplification constant of about 30, while the other two have an amplification constant of 6 to 7. The undistorted output is about +10 TU, the output tube having an oscillator rating of approximately 5 watts. The audio output rating of 100 milliwatts, corresponding to +10 TU, is conservative. The amplifier affords a total amplification of 80 TU, variable in steps of 3 TU from 20 TU to the maximum. The response is flat

not markedly better than the audio units of high-quality broadcast receivers.

Returning to the comparison between the audio system of broadcast transmission and the equipment employed in

sound movie technique, note Fig. 7, showing the circuit elements of a broadcast station between the microphone and a wire line leading to the radio station, or feeding other broadcast transmitters in a chain. Here the amplifiers described above are shown, and in addition a single-stage monitoring amplifier known as the 9-A. There is also a mixer for combining the outputs of three microphones (more may be used, if desired), a level indicator, and an artificial line between the 8-B and 17-B amplifiers. This is a simplified schematic diagram, and the reader who wishes to go more deeply into this phase of the subject is referred to the writer's paper on "Broadcast Control Operation" in the April, 1928, issue of the *Proceedings of the Institute of Radio Engineers*.

Now compare Fig. 7 with Fig. 8, which

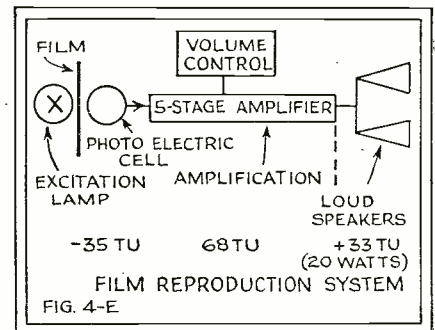

represents the elements of a film recording system, adapted from Donald MacKenzie's excellent paper on "Sound Recording with the Light Valve," in Vol. XII, No. 35, of the *Transactions of the Society of Motion Picture Engineers*. The basic similarity of the two is evident. The greater complexity of the monitoring system in Fig. 8 is explained by the fact that it may be switched to a photo-cell output in the recording machine, which receives that portion of the exposure light passing through the film as the record is made (about 4 per cent), so that the operators may hear in a monitoring loud speaker the actual modulation which is being photographically recorded. Since the photo-cell output must be brought up to loud speaker volume, extra amplification is required; otherwise the 9-A amplifier across the 8-C output would be sufficient, as in the broadcast system of Fig. 7.

The similarity continues in Fig. 9, which shows a film-and-disc theatre reproducing system. Here the difference in

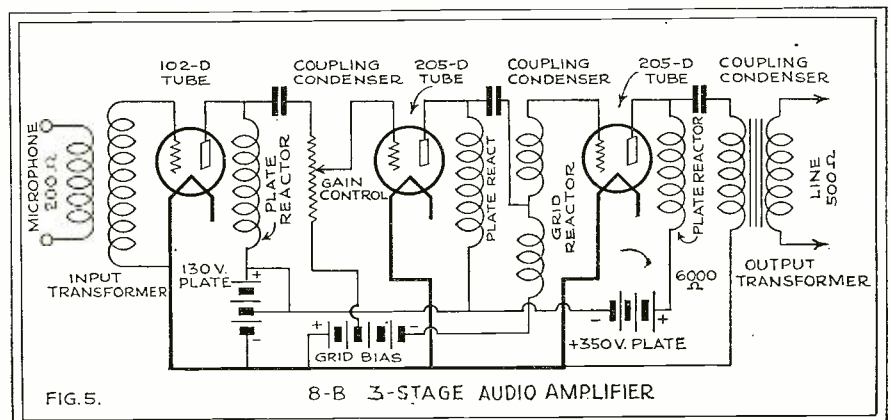
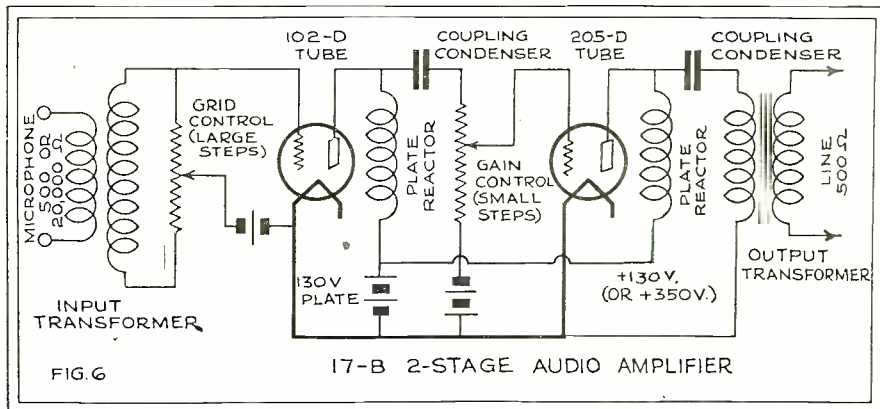

FIG. 5. 8-B 3-STAGE AUDIO AMPLIFIER



output level between the disc and film is compensated for by the film amplifier, which is mounted on the motion picture projector as part of the sound head. The fader is a combined change-over between the two projectors, and a volume control; it corresponds, in a measure, to the mixer shown in the recording or broadcasting diagrams of Figs. 8 and 7. Then the 8-B amplifier follows once more, supplying the necessary voltage amplification, but as a large amount of audio energy is required to fill a theatre, the final stage is the 10-A unit, which utilizes four 211-E tubes in a parallel push-pull circuit, at a plate potential of about 750 volts. These are tubes of the 50-watt (oscillator rating) size.

Basically, it is plain, there is little difference between the audio-frequency technique of radio and the corresponding problems in sound motion picture recording and reproduction. The sound movie technique, however, is complicated by the addition of light to sound. This is what makes it interesting to the bored radio man who, of course, mastered all the problems of sound long ago, soon after he took his correspondence school course. Aside from the optical elements, which are usually perversely critical in their adjustments, the whole process of recording and reproduction is complicated by the reaction of the two sensory fields on each other. That is, when you add sound to scene in reproduction, you get something not merely twice as complicated as either, but four times or ten times as complicated. (My estimate of the exact multiplying factor which should be applied varies from day to day, with the exigencies of my own job.) For example, sound pick-up in broadcasting, while by

no means simple, is given considerable latitude by the fact that the performers are unseen and may be placed at the pleasure of the studio staff in the best

positions relative to the microphones. But in sound movie pick-up the necessity for keeping the microphones out of the camera field, and utilizing the camera angles and mode of acting which have been found effective in motion picture presentation, complicate the sound pick-up problem enormously. Only one fact comforts the sound engineer—he knows he is making things just as hard for the camera man and the movie technicians.

Another instance of this complexity is found in the acoustic end. In broadcasting, after a studio is properly designed, constructed, and modified, the characteristics are known and pick-up is readily controllable, particularly with broadcast artists as well trained and tractable as the professionals developed in the last few years by the radio concert bureaus. But in the movies, even with a well-designed studio, every time a new set is

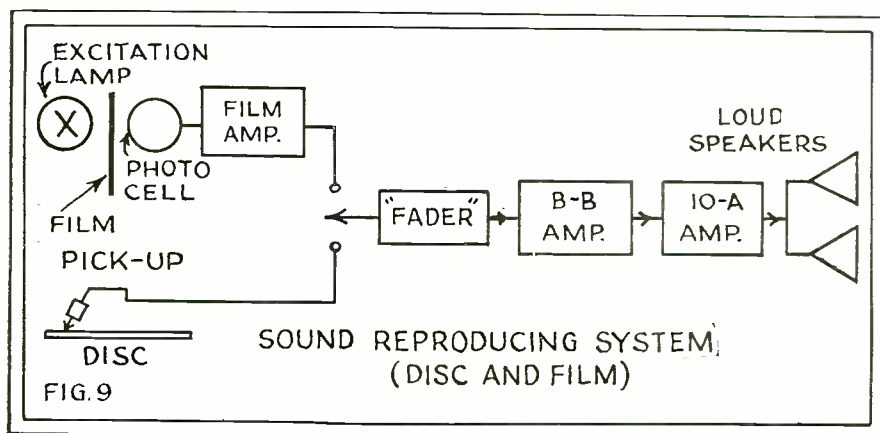
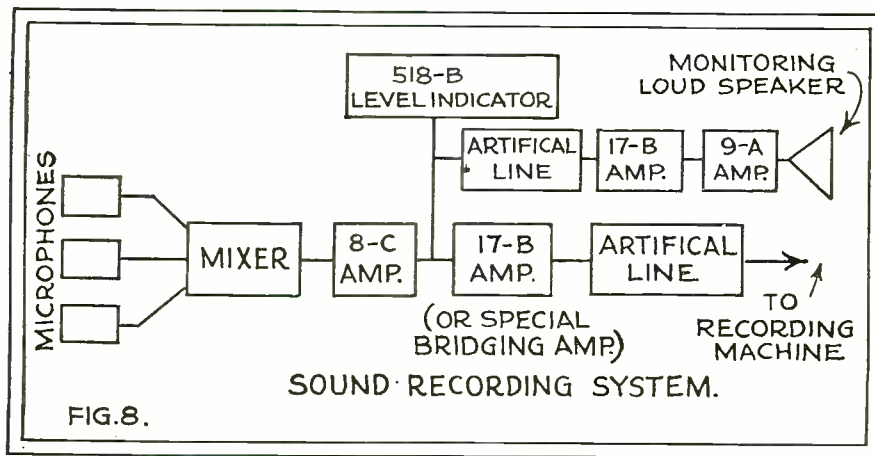
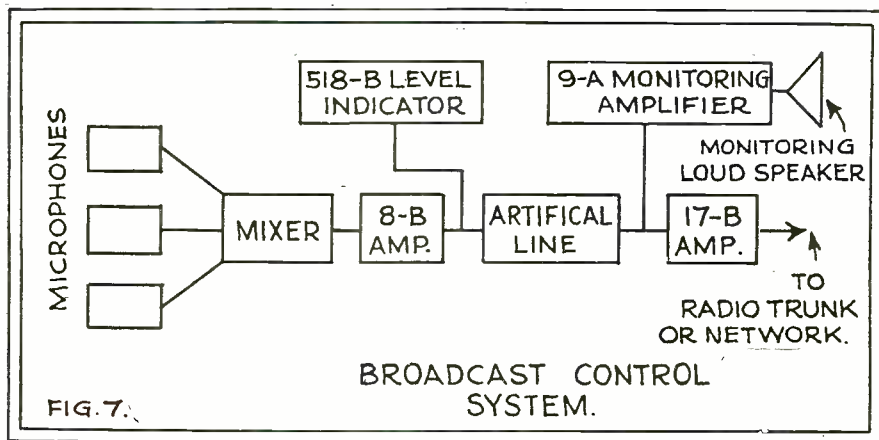

constructed the pick-up problem changes and intelligent adjustment is demanded. All that correct studio design insures is that extraneous noises will be excluded and the period of reverberation of the studio will not be too high, so that sound escaping from the set and returning to it will not interfere with high-quality pick-up. But within the set itself there may be annoying flutter echoes, resonances, and reflections, especially when hard scenery is used and speech must be picked up at considerable distances and reproduced with clarity later on.

These are typical problems encountered by the radio engineer who was first occupied with telegraphing symbols through
(Continued on page 171)

The War Correspondent Takes to the Air

Aviation—Sham Battles—and Radio

By ZEH BOUCK

THE glamorous possibilities of war reporting have fascinated us since we first read the writings of Richard Harding Davis and later the pen pictures of Phillips Gibbs. To date our combative experiences, other than the domestic variety, have been rather meager. Once we held a target for a fellow marksman, with the result that his father, who happened to be the village doctor, gouged a B-B shot out of our right ear, free of charge. And once we made some gun powder that gave forth the authentic aroma. But the insatiable desire to blend the rat-a-tat-tat of our typewriter with the similar staccato of machine-gun fire is still no more than the echo of a boyhood ambition, and so we ask the kind reader to indulge us while we describe the broadcasting of the recent aerial maneuvers over the State of Ohio through WLW as

The Diary of a War Correspondent

Sunday, May 19, Brooklyn: A request has just come through to the Pilot Electric Manufacturing Company from B. H. Darrow in charge of educational broadcasting of the State of Ohio in peace times, and now, since the declaration of war, heading the Bureau of Propaganda, to send our flying radio laboratory to the scene of the conflict. Station WLW is

THE AUTHOR, WITH LOUIS MEIER, PILOT, AND B. H. DARROW, ANNOUNCER

now in the hands of the Red army, and Darrow says they will rebroadcast description of aerial battles, from Red point of view, if we can get through. The idea is to stimulate enlistment and bolster up the morale of the citizens. 'Phoned Louis Meier, our pilot, and told him to have the motor checked over. According to coded message from Darrow, Blue Army plans to attack Columbus, and desperate remedies are being sought to stem the tide of the enemy advance. Shipping spare tubes, and a special receiver to the hangar at Roosevelt Field today. Receiver is a redesigned Super Wasp with heavier condenser plates and wider spacing to reduce modulation of incoming signals by noise in the plane.

Monday, May 20, Roosevelt Field: All in readiness for take-off early tomorrow morning. Checked over entire radio system carefully today, running tests with our land station W2XCL. It is possible that we shall have to fly through rain and so we taped the ignition shielding and shellacked. Have been having trouble with untaped shielding. Rain causes a breakdown between spark plug heads and the grounded shielding, and the engine misses. All okay now.

Another coded message from Darrow. Anticipates heavy air fighting during the next few days. Planes of the Red Army are mobilizing at Norton Field, Columbus, and those of the Blue Army at Wright Field, Dayton. At last we may settle the eternal question of what class of

plane is the best fighter.

The ardent pursuit pilot, whose sole function is to go out and "get" the enemy's airplanes, will tell you that he can always destroy any of the enemy's airplanes except, perhaps, their pursuit planes—that bombardment planes, attack planes, and observation planes are easy



B. H. DARROW, IN CHARGE OF EDUCATIONAL BROADCASTING, STATE OF OHIO, WHO DESCRIBED THE AERIAL MANEUVERS

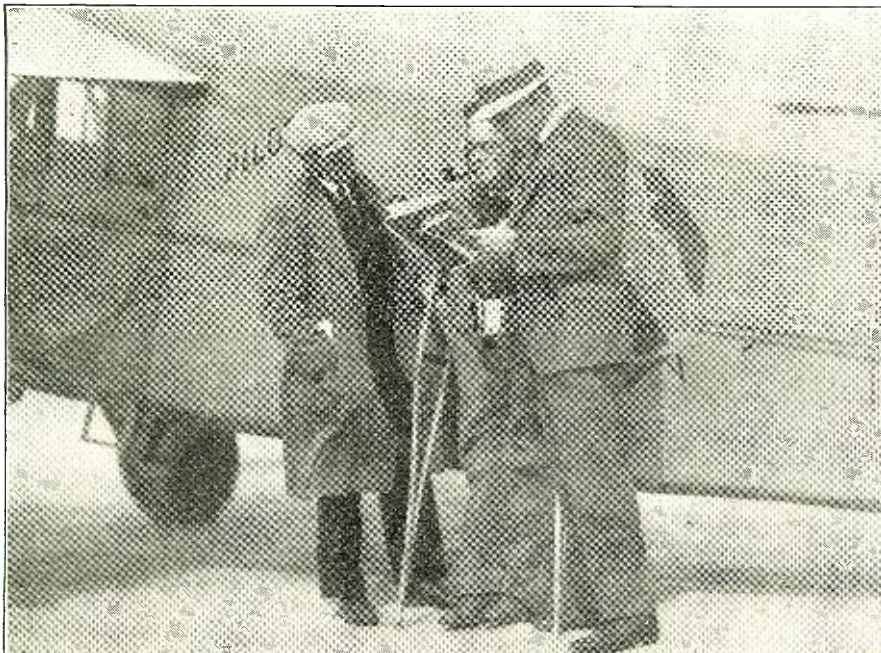

prey for the swift, maneuverable pursuit plane. Among many other advantages of his pet, he will cite speed. That of the—

Bombardment plane is 90 mi. per hour.

Attack plane is 135 mi. per hour.

Observation plane is 140 mi. per hour.

Pursuit plane is 175 mi. per hour.

Some of the prominent aerial records of the World War bear out this contention—Richtofen's, for instance. Of his eighty victories, an overwhelming proportion consisted of observation airplanes, with a very small proportion of pursuit planes.

The bombardment pilot, who drives his heavy, cumbersome bomber far into enemy territory to drop his bombs on the enemy's ammunition dumps, factories and back areas, will tell you that, while he can't chase the enemy pursuit planes, his bombers are reasonably safe as long as they fly in close formation. The enemy pursuit will be exposed to the fire of so many machine guns that he will fall a victim to somebody's gun before reaching the bombardment flight.

The attack pilot, whose function is to spray ground targets with machine-gun

fire or light bombs (from a very low altitude) will tell you that, as he always flies in formation to and from his objective, an attack by pursuit planes is not greatly to be feared.

The only pilot who does not argue much with the boastful pursuit pilot is the observation pilot, who must drive his two-seater plane out over the hottest part of the battle and report its progress to headquarters by radio, or perhaps assist artillery to find and hit targets. The observation pilot, with his observer, must frequently be unaccompanied by other planes; hence is easy prey for two or three pursuit planes. It was this type that formed such a large proportion of Richtofen's bag. The observation pilot's only defense is to fly in close formation (when there are several planes on the same mission) or to pray lustily for adequate protection by friendly pursuit planes when he must venture forth on a lonely mission.

Tuesday, May 21st, Columbus: Got through O.K. Saw plenty of Red planes, but no enemy ships. Bumpy over the mountains. Came down at Uniontown for gas, and had quite a talk with the Army operator at the radio station there. He tells me that there is much activity; and a lot of radio stuff is coming through from bombing planes, operating on about 900 meters. Their range seems to be limited, however. Copied some of it myself, as we passed over Zanesville, Ohio. It looks as if the 40 meter band is better for airplane transmitting purposes. Some of the bombers are carrying 500 watt transmitters, and yet the reliable range is limited, according to my own observations and those of the army station at Uniontown, to under 100 miles. He told me that the bombing plane that bombed Governor's Island, New York, faded out completely when it was eighty miles away.

Wednesday, May 22: The clash between opposing ground forces of the Blue and Red armies in the combined Air Corps-Ground maneuvers is inevitable tomorrow.

At dawn this morning eight divisions of the Blue Army moved across the International Boundary, a line running north and

MAJOR GENERAL JAMES M. FECHET,
CHIEF OF AIR CORPS, U. S. A.



south about two miles west of London, and are advancing toward Columbus, which the Red Army seeks to defend. These divisions completed concentration along the boundary last night at dusk and bivouacked there.

Today finds these fighting elements ranged from Woodstock on the north to South Charleston on the south, in the following order:

Unionville Center, 84th Division, Indiana Organized Reserves, Brigadier General L. R. Gignilliat, commanding.

Chuckery, 38th Division, Indiana, Kentucky, West Virginia, National Guard, Major General R. H. Tyndall, commanding.

Resaca, 37th Division, Ohio National

THE AUTHOR OPERATING THE AIR-PLANE TRANSMITTER-RECEIVER



Guard, Brigadier General Frank D. Henderson, commanding.

Plumwood, 83rd Division, Ohio Organized Reserves, Colonel Orval P. Townshend, commanding.

Lafayette, 100th Division, Kentucky, West Virginia Organized Reserves, Colonel L. L. Roach, commanding.

Lilly Chapel, 5th Regular Army Division, Colonel G. G. Townsend, commanding. The First Blue Corps with headquarters at Mechanicsburg is commanded by Brigadier General George H. Jamorson, Regular Army and the Second Corps at London by Major General Benson W. Hough, Ohio National Guard.

Two cavalry divisions are covering the advance of the Blue troops, according to the plan.

All during last night, the 9th, 10th, 11th, and 12th Blue Regular Army Divisions were advancing, from their mobilization areas, toward the boundary line. They are one day's march in the rear of the advance troops and probably will continue the march today.

Mobilization points of these divisions were as follows:

- 9th Division, Miamisburg, Ohio.
- 10th Division, Vandalia, Ohio.
- 11th Division, Troy, Ohio.
- 12th Division, Dayton, Ohio.

Supporting these Divisions of the First Blue Army are the Blue Air Forces actually represented by about 100 planes

and the Second and Third armies, which have mobilized at points throughout the Blue part of the United States and are now invading the Red State to the north of the First Blue Army.

The Red forces also have three field armies inferior in strength to the Blues, which means that the combat activities this week will involve almost a million men representing every state and city of the nation in the greatest combined air-ground maneuvers ever staged by the United States Army.

Blue Army headquarters at Fairfield are in command of Major General Dennis B. Nolan.

The First Blue Army has information that the Red forces this morning had concentrated five divisions along the east bank of Darby Creek. Blue Air Force observers report that the Red right is

resting east of Plain City and the left opposite and east of Harrisburg. Another Division was reported going into bivouac at Lockbourne, eight miles south of Columbus. Three other divisions and a large number of corps and army troops were bivouacked in the area around Newark, Columbia Center, Buckeye Lake and Alexandria, having marched last night from the east.

The Divisions at Darby Creek were entrenching their position for the defense of Columbus. Small covering infantry and artillery detachments were pushed to the west to a north and south line about seven miles west of Darby Creek. They were in turn covered by a division of cavalry. Another cavalry division is protecting the south flank of the Red Army.

* * *

Shortly after 9:00 a. m. today, the two Blue cavalry divisions engaged in a skirmish with the Red cavalry, and inasmuch as one Red Division had been sent to protect the left flank, remaining troops were outnumbered two to one and quickly forced to withdraw to the southeast, with Blue cavalry following.

Red cavalry withdrawal uncovered the covering detachments of infantry and artillery. As the Blue Infantry followed the cavalry in, they came in contact with Red Infantry and Artillery along the general line Bridgeport, Resaca, Lafayette and Chrisman.

The Red covering detachments were greatly inferior in strength, having been posted for warning and delay of Blue troops rather than to engage in a defense at all costs.

While the Blue troops took up battle formation, the Reds gained time for an orderly retreat to a nearby ridge. By noon, the Blue Infantry had driven the Reds back along the line for a distance of about three miles.

It is expected that the Reds' action in withdrawing with slight resistance will bring the Blue forces within reach of fire of Red heavy artillery at the Darby Creek line before nightfall.

This heavy artillery has been reported by the Blue Observation Aviation as being in position east of the line which Red troops are entrenching.

The Blue observation group sent out by

A VIEW OF PART OF THE SCENE OF
"BATTLE"



Lieutenant Colonel H. G. Pratt, Aviation commander, First Blue Army, is conducting reconnaissance to gain information of the Reds' entrenched position, particularly the positions of Red artillery, and of the advance of their reinforcements coming up from the rear. The Blue bombardment forces, during the early afternoon, attempted to destroy several bridges over the Scioto River, but were driven off by Red anti-aircraft artillery. An air attack to delay Red troops coming up from the rear probably will be carried out before nightfall.

Blue pursuit planes are engaged in escorting their bombardment and attack formations.

Blue attack by air will encounter three to one superiority of the Reds in pursuit ships. Blues have a similar ratio of superiority over the Reds in bombardment planes.

Thursday, May 23rd: All quiet on the Big Darby. But forces of both armies are concentrating on the Creek. Checking over radio apparatus again. Arrangements made for broadcast tomorrow over WLW. The pickup will be at the stadium of the Ohio State University, and over landline to WLW. Installed receiver this morning, and everything is ready. Darrow is in

charge of propaganda, and will do the speaking. Louis will pilot and I'll operate the transmitter and receiver.

Friday, May 24th: What a day! Thick as pea-soup this morning. Fog and low ceiling. Took-off Columbus airport for a test with the ground receiver, and found everything O.K. with the exception of a little trouble with the microphone. Cleared that up later. Pursuit and bombers flew overhead west for the battle at noon, and we took-off immediately, circling back toward the city for a final O.K. from the college. Higgy told me that everything was ready, as soon as they got the line through, but didn't know what the delay was. Probably the Blue Army had bombed the direct lines. However, he told me to standby, shortly after, and we headed for Big Darby Creek. I tuned in WLW, waiting for our cue. Fifteen minutes later, the announcer said that he was transferring the radio audience to the plane. This meant that the short wave re-

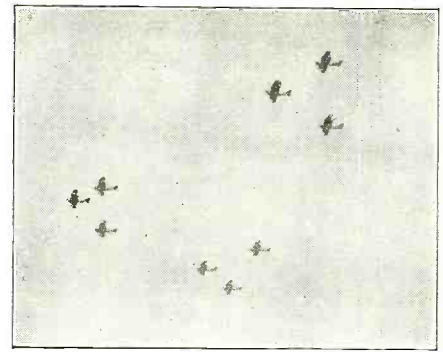

PURSUIT PLANES FLYING IN FORMATION

ceiver, tuned to W2XBQ (our airplane transmitter operating on 45 meters) was connected to the control board at WEAO (the pick-up at the college). I threw the transmitting switch, spoke into the mike, and introduced Darrow. Higgy, operator at WEAO, made a transcript of what Darrow said, and sent it to me later. Here it is:

"Much activity can be seen along and in the territory both to the north and south of the National road leading east to Columbus. The Blues are driving forward hard, meeting stubborn resistance by the Reds, occupying prepared entrenched positions on the higher ground to the east of Darby Creek. The Reds, naturally, are making a determined effort to defend their important base and Capital, Columbus, and the Blues are as determined to capture it.

"The Blue forces crossed the International Boundary, a line running generally north and south through Toledo, Bowling Green, Findlay and about thirty miles west of Columbus. They are opposed by two Red Cavalry Divisions which our advance cavalry detachments drove off. On the 22nd reconnaissance continued while Blue heavy artillery, supplies and ammunition were being moved forward and orders prepared for the forthcoming Blue offensive. On this day contact with the enemy patrols was maintained.

"At daybreak of the 23rd, the Blue Army launched a determined attack, all

B. H. DARROW BROADCASTING FROM
THE SPECIAL AIRPLANE SHORT-WAVE
TRANSMITTER

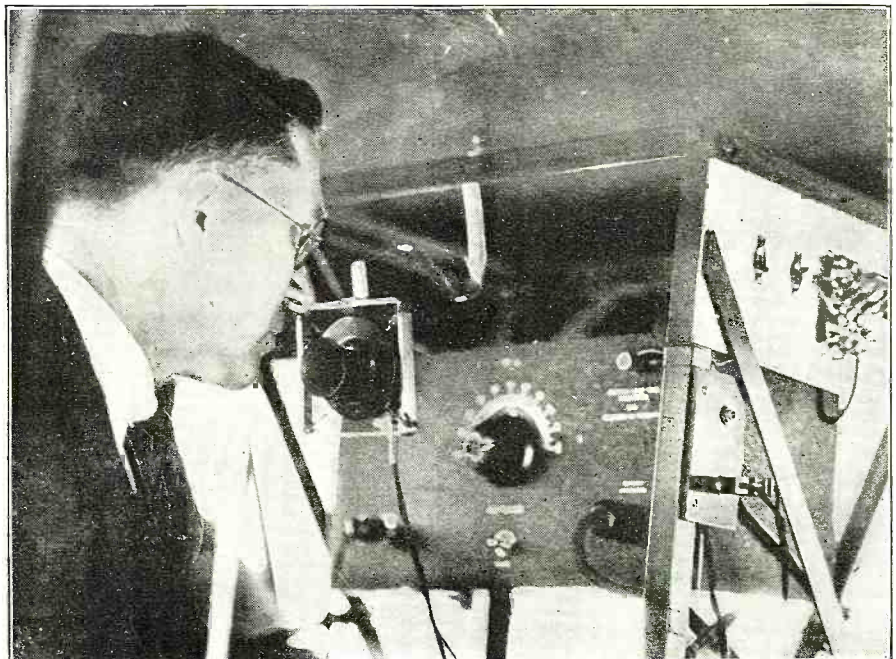

along the line, and quickly drove the Red outpost into the hostile battle position which had been entrenched, to the east of Darby Creek. At 3:00 p. m. today the entire First Corps had crossed Darby Creek and were well into the enemy territory. The 83rd and 100th divisions to the south had just crossed Darby Creek and held the east bank. The 5th Division, veterans of the World War and known as the Red Diamond Division, has met with more determined resistance to the south and had not crossed Darby Creek up to late last night.

"To the north I can see the fighting 37th Division of the Ohio National Guard, veterans of the battlefields of France, pushing forward towards Hilliard. They are opposed by the Red Second Division and part of the Red First Division. To the north of the Ohio contingent and fighting by the side of the troops of its sister state, is the famed 38th Division of the Indiana, Kentucky and West Virginia National Guard. The regiments of this Division also have streamers and citations won on foreign battlefields during the war with Germany.

"We have just swooped down low over a small farm which I identify on my map as that of W. A. Geyer, which is located about four miles northeast of West Jefferson. Blue Infantry patrols of the 100th Division can be seen working rapidly eastward, apparently not encountering very determined enemy resistance. However, just to the south of this place the Blue line has not progressed as far. Much activity can be seen in the Red territory where reserves are being marched along the National Route to reinforce their front line troops.

"Over and above the roar of our plane can be heard the rumble of both our heavy artillery and that of the enemy. I can occasionally see puffs of smoke in the rear areas of the opposing forces, where heavy artillery is supporting the attack of the Blues, and the defense of the Reds.

"We have traveled southward over the area being crossed by the 'Fighting Fifth Division.' This Division was held up in the crossing of the Darby yesterday afternoon, but by renewed vigor and energy have pushed forward aggressively in their zone of action, bringing their part of the line considerably east of Georgesville where at 3:00 p. m. they are meeting with resistance from the veteran enemy 9th Division, which has been in the front line continuously since the beginning of hostilities.

STAFF OF OFFICERS OF THE BLUE ARMY

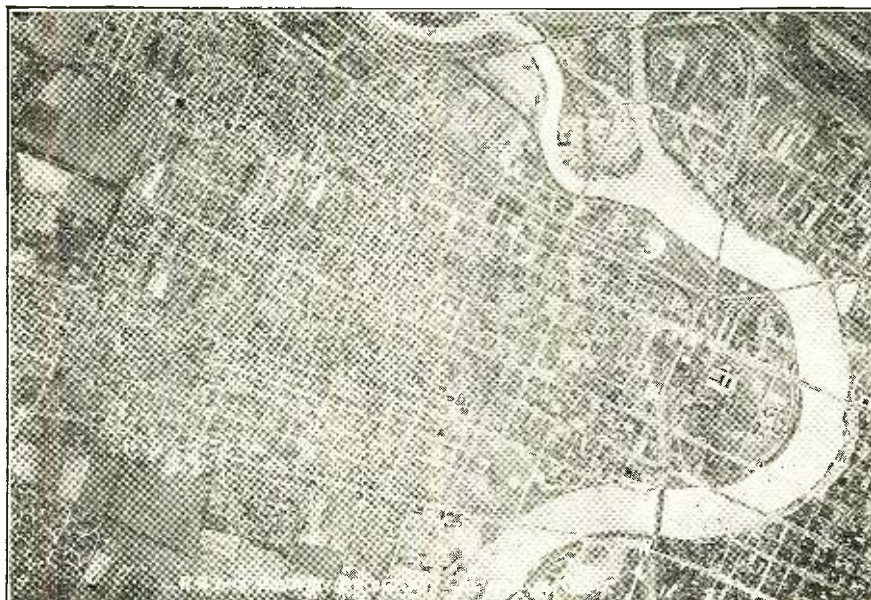

OVER THE HEART OF COLUMBUS, OHIO

"We have turned our plane northward and again passed over the troops of the 100th Division. I can see their leading elements in the vicinity of J. Dortz Farm. From the continued sputtering of machine guns, it is apparent that a stiff fight is taking place in that vicinity. As we continue northwest over the area occupied by the 83rd Division we can see the front line units of its right regiment being held up by heavy machine gun fire in the vicinity of woods just north of Caldwell Corners. Apparently they have called for artillery support for at this moment I can see shells bursting all over the wooded area, and as we are at a low altitude can see the Blue troops preparing for an assault on this tract of woods, under the protection of their own artillery fire. You see that I have a good opportunity to see how the artillery fire can help out the 'doughboy' when he gets up against a tough proposition.

"Oh, boy! We had better leave this sector. We either got too close to that shelled wooded area or that Blue artillery is doing some poor shooting. Maybe they took us for an enemy plane.

"We have just received a radio that severe fighting is taking place up north in the area now occupied by the 84th Division. We will now start north; it being about 12 miles, it should take 7 or 8 minutes to get up there.

"As we continue north we can see the Blue line in general in the vicinity of the

C. E. Jolley Farm—Pleasant Ridge School House—the H. Keeler Farm—Hayden, the A. Cary Farm, just east of the T. & O. C. railroad, to the vicinity of Lambs Corner.

"Here we are down low where the 'sput, sput' of machine guns, automatic rifles, and rifles indicate terrific fighting. In the open fields can be seen many prostrate figures indicating that casualties have been heavy on both sides. Information we received by radio was to the effect that at 2 p. m. the Blues had reached the road running north and south across Indian Run Creek, but the enemy immediately launched a counter-attack and drove the Blues back to their present position, about 1,000 yards back to the west.

"Due to heavy artillery shelling apparently called for by the 84th Division to assist them in their advance, we have climbed to considerably over 5,000 feet where a misty panorama of the entire battle field can be seen.

"Much activity can be observed in the Red rear areas where both reinforcements and artillery are being brought up in a frantic endeavor to stem the Blue attack coming down.

"Large concentration of heavy artillery from the roar of their back area guns is apparent. It is evident that the Reds are putting everything into the defense of their principal city and Capital. Altitude, 1,500 feet."

At this point the weather became so thick as to make flying too dangerous for
(Continued on page 171)

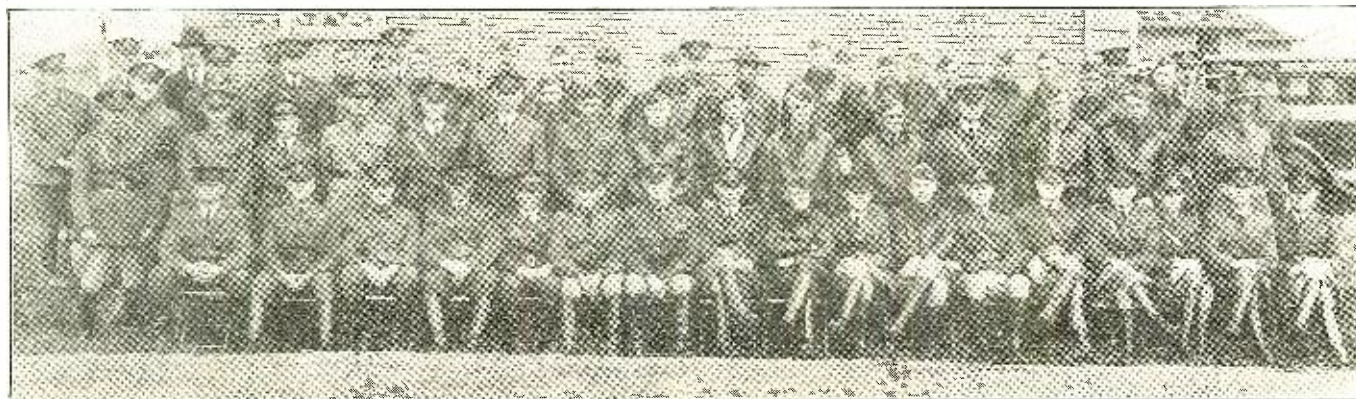

The Theory and Design of Band Pass Filters

The First of a Series of Practical Articles on Tuned Filter Construction

BY JOHN RIDER

JUDGING by indications visible at this time, receivers equipped with band pass filters will be the most popular. This applies to the superheterodyne receiver as well as the tuned radio-frequency amplifier, despite the fact that the former classification of receivers is in the minority. The tuned radio-frequency receiver in particular will be exploited with band pass filters, made necessary by the complex status of the air and by the demands for better tone quality in addition to the required degree of selectivity.

In days gone by one overlooked the small amount of sideband suppression to be encountered in the radio-frequency sections of tuned radio-frequency receivers. At this time, however, even this minor fault must be corrected. . . . The war cry is for selectivity and tone quality. . . . The public must be served!

But what is a band pass filter? . . . We hear so much about them. . . . What is the band pass? . . . What is the filter? . . . Both sound technical, yet the subject itself is relatively simple. When mentioned, its comprehension is retarded by some large technicality, which actually is fictitious. Few realize that every tuned stage in a radio-frequency receiver is in itself a tuned band pass filter, for does it not pass 3000 or 4000 or 5000 cycles each side of the resonant point? The regular band pass filter designed for the purpose differs in only one respect, that a number of tuned circuits are employed in order to improve the shape of the resonance curve of the system. Herein lies the advantage available with the regular band pass filter. In the ordinary tuned radio-frequency stage, the actual peak is upon the carrier frequency or the resonant frequency. From that point on for the distance represented by the sidebands, the amount of energy present in the circuit on the sidebands or the sideband frequencies gradually decreases, so that at 4,000

cycles the amount of energy in the circuit may be 10% of the energy at the resonant frequency or the carrier frequency of, say, 65% of the energy in the circuit on 1,500 cycles.

The design of the band pass filter eliminates this condition. As a matter of fact, it would be better to say that it corrects this condition. The correct condition consists of assuring that the amount of energy present in the circuit on the carrier or resonant frequency and the sideband frequencies is practically the same. We say "practically," because the factors governing the design of the components in the circuit make it impossible to achieve the ideal condition. What has been said is a simple explanation of the band pass filter and should suffice for the introduction to the subject. We will, as we progress, dwell at greater length upon the design of such circuits.

This series will consist of four articles, the present one describing the underlying principles of various forms of radio-frequency band pass filters; the second, describing the principles of operation of various superheterodyne band pass filters; the third, describing the construction of various types of tuned radio-frequency band pass filters; and the fourth, describ-

we analyze the superheterodyne intermediate band pass filter.

In order to permit utmost comprehension of the tuned radio-frequency band pass filter, it is necessary to delve somewhat into the principles underlying ordinary resonant circuits and coupled circuits. Every resonant circuit, regardless of its type, consists of a capacity and an inductance or of a number of capacities and a number of inductances. The usual resonant circuit employed in tuned radio-frequency receivers consists of an inductance and a capacity arranged as shown in Fig. 1; L representing the inductance and C the capacity. The circuit is resonant to any one frequency when the reactance of the inductance or XL is equal to the reactance of the capacity or XC.

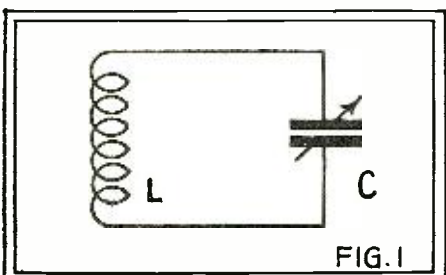

FIG. 1

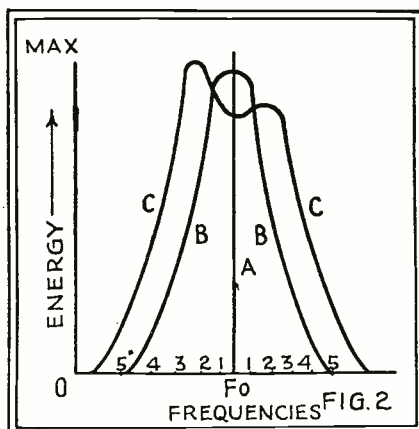

FIG. 2

ing various forms of superheterodyne band pass filters.

Judging by the type of units employed, the band pass filters employed in superheterodyne receivers differ somewhat from the systems employed in tuned radio-frequency receivers. In view of the greater popularity, let us consider the radio-frequency band pass filter before

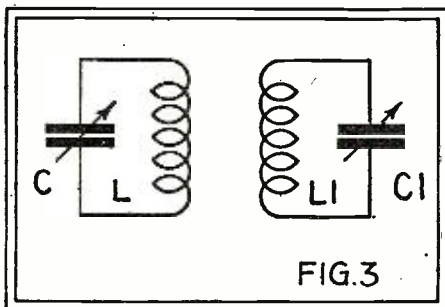

FIG. 3

Expressed differently, resonance is secured when $XL = XC$. In order to prepare the way for other material to follow, let us employ another expression to show the condition of resonance in a tuned circuit. This is

$$f = \frac{1}{6.283 \sqrt{L \times C}} \text{ or } \frac{1}{2\pi \sqrt{L \times C}}$$

the reciprocal of the square root of the inductance times the capacity, multiplied by 2 pi is the resonant frequency of the circuit. However, before we proceed it is necessary to explain the significance of inductive and capacitive reactance.

Resistance in any circuit is the opposition of that circuit to a force applied to the circuit. A steady current (d.c.) in a circuit meets but one opposition, the d.c. resistance of that circuit. In a.c. circuits, however, where the direction of current flow changes periodically, according to the frequency of that circuit, the above does not hold true. If a condenser is present in the circuit, it manifests a controlling influence upon the current

flow in the circuit by virtue of the constant charging and discharging of the condenser. This controlling influence is really in opposition to the current in the circuit and the extent of opposition is designated as the "reactance" of the condenser and is expressed in ohms. The "reactance" of a condenser is designated as XC and quoted as capacitive reactance, since it is associated with capacity. The reactance of condenser is determined by means of the formula

$$2 \quad XC = \frac{1,000,000}{6.283 \times F \times C \text{ mfd.}}$$

1,000,000 divided by the product of 6.283 times the frequency in cycles times the capacity in microfarads.

As is evident in the formula, the reactance of a condenser decreases with each increase in frequency and conversely increases with each decrease in frequency. Likewise it increases with each decrease in capacity and decreases with each increase in capacity, assuming constant frequency.

In contrast to an a.c. circuit containing a condenser, the reactance of an a.c. circuit containing an inductance increases

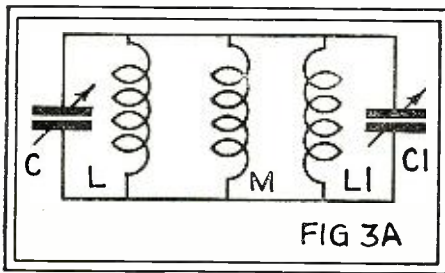

with each increase in frequency and with each increase in inductance, and the opposition to the flow of a.c. current due to the presence of the inductance is due to the inductive reactance of the inductance, designated as XL, and determined by means of the following formula:

$$XL = 6.283 \times F \times L, \text{ or}$$

the inductive reactance is equal to the product of 2 pi multiplied by the frequency in cycles times the inductance in henrys. The presence of the inductance introduces other factors, such as effective resistance and impedance, but since these values are not involved in our discussion we will omit detailed explanation.

Referring once more to the circuit shown in Fig. 1, we find that it is identical to the conventional arrangement employed in myriad radio receivers. If we could secure an ideal state, where the capacity and the inductance would be free from resistance, the resonance curve of the unit would be a straight line at the resonance frequency, as line A in Fig. 2. The height of the line may be considered as representative of energy in the circuit, Fo in this case being the resonant frequency. However, resistance is present and the result is that the energy in the circuit is distributed over the resonant frequency and over a band of other frequencies, as shown by curve B. If we consider the numerals 1, 2, 3, 4 and 5 as being 1,000, 2,000, 3,000, 4,000 and 5,000 cycles each side of the resonant frequency, the fact that the energy distribu-

tion is not uniform is self-evident. Such sideband suppression impairs the quality of reproduction, since some of the high notes lying within the 3,000 to 5,000 cycle range transmitted by the broadcasting station are attenuated in the radio-frequency amplifier and do not reach the audio-frequency amplifier in their original degree of intensity.

In addition, the energy in the circuit is governed by the amount of power fed into the circuit. The greater the amount of received power at the receiver, the greater the amount of power in the receiver circuits. If this power is of sufficient magnitude it will extend beyond the normal range in the receiver and interfere with the reception of another station. Accordingly the ideal radio-frequency amplifier must fulfill two conditions, satisfactory selectivity and no attenuation of sidebands. In this connection we must qualify the statement of no attenuation of sidebands. Empirical determinations have shown that a loss of 10% in amplitude between relative frequencies is permissible. So much for that, at the present time.

The reader of these pages is undoubtedly familiar with the fact that energy present in one circuit may be transferred to another circuit by means of various linking mediums. Electrical phenomena are such that when current is caused to flow through a wire, a magnetic field is created around that wire. If two coils of wire are placed adjacent to each other, so that the magnetic lines of force created by current flow through one of the coils, cuts the turns of the other coil, energy is passed from one coil to the other, and the two coils possess what is known as "mutual inductance"; that is, a certain value of linking inductance between them and common to both. The passage of electrical energy between the two circuits which have no direct conducting path between them is via the mutual inductance of the two coils.

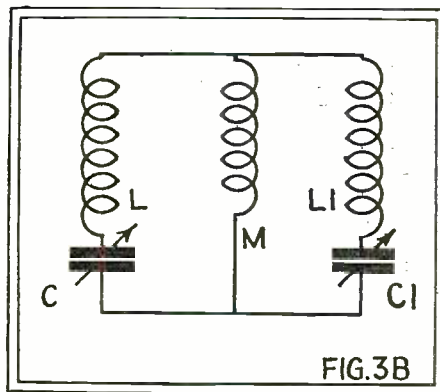

What was said about inductances is applicable to tuned circuits. If we consider two circuits such as that shown in Fig. 1, and both tuned to the same frequency, they will respond to the same frequency when the mutual inductance between them is small or negligible. The reason for this is that the mutual inductance common between coils reacts upon the inductance values of the coils. Any such influence will vary the original value of inductance, hence the two circuits will not respond to the original frequency.

Assuming any two circuits, such as shown in Fig. 3, loose coupling between these two circuits permits resonance at one and the same frequency. However, if the coupling between the two circuits is increased by increasing the mutual inductance between the two coils, each circuit will be resonant to two frequencies; the phenomenon required for band pass filters. The condition of mutual inductance between the two circuits shown in Fig. 3 may be represented by the schematic diagram in Fig. 3A, where L is the inductance of one circuit, L1 is the inductance of the other tuned circuit and M is the linking or mutual inductance between the two circuits. In this connection the only link between the two circuits is that due to M. The difference in frequencies is due to the action of the mutual inductance M, which alternately subtracts from and adds to the inductance of each circuit. This action causes a curve such as that designated as C in Fig. 2. The greater the value of the mutual inductance or the coupling between the two circuits, the greater the separation between the two peaks in the resonance curve. Such curves are known as "double peaked" curves. As is evident, we are concerning ourselves with inductive coupling between circuits despite the fact that similar results are obtainable with capacity coupling. The reason for this is the prevalent use of inductances as the coupling mediums in tuned radio-frequency band pass filters. A practical tuned radio-frequency band pass filter is shown in Fig. 3B, with designations similar to that of the system shown in Fig. 3A.

Bearing in mind that, when loosely coupled, the two circuits respond to the same frequency, the addition of the mutual inductance M creates two new resonant frequencies determined by

$$F1 = \frac{1}{6.283 \sqrt{(L + M) \times C}} \text{ and}$$

3

$$F2 = \frac{1}{6.283 \sqrt{(L - M) \times C}}$$

Compare formulae 1 and 2 and 3. Note the presence of the mutual inductance M. Now, the use of such designations as L and C and M may be confusing. Let us therefore interpret these values into the exact values used. Suppose that L and L1 in Fig. 3A are of 180 microhenrys and C and C1 are .00025 mfd. each. M is 5 microhenrys. Analysis of formula 3 shows that the 5 microhenrys available in M is added to the 180 microhenrys available in L and L1 and creates a new resonant frequency, lower than the original F, since the inductance in the circuit has been increased. Then, the inductance of the unit M is subtracted from the values of L and L1, creating another frequency, F2, higher than either F or F1, since the value of inductance in the circuit has been decreased.

Now, in connection with the design of these systems, we must interpret the value of mutual inductance in mutual reactance, because of certain associated phenomena which manifest themselves

(Continued on page 172)

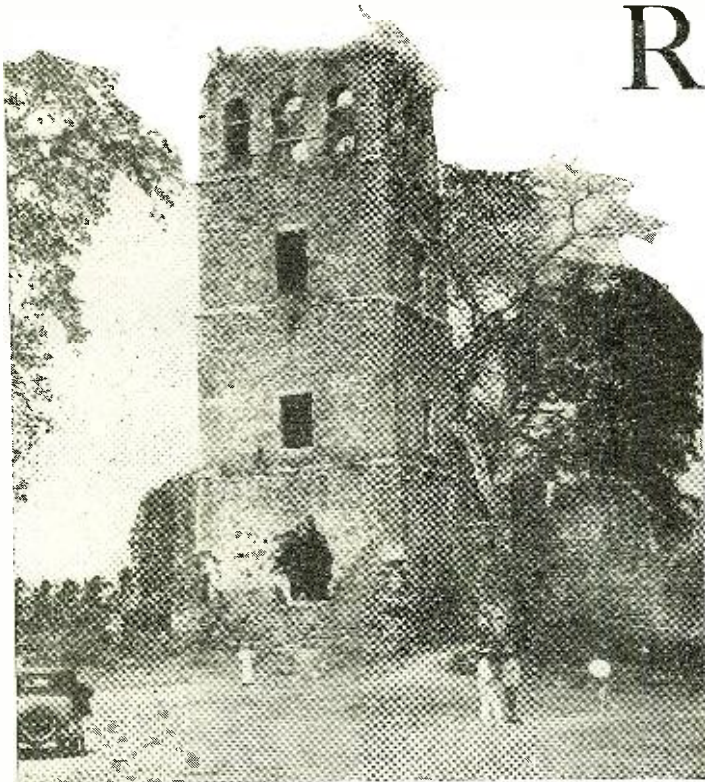

TOWER OF THE CATHEDRAL OF SAN ANASTASIA IN THE RUINS OF OLD PANAMA CITY

Radio Locates Buried Treasure

How Lieutenant Williams, Former Radio Officer in the British Navy, Has Applied Radio Principles to an Age-Old Quest

BY
CHARLES E. CHAPEL

Lieutenant, U. S. Marine Corps

SCIENCE and Romance have met in the vine-covered ruins of Old Panama City! Lieutenant George Williams, formerly a radio officer in the British Navy, is unearthing the wealth of plate and jewels buried by the inhabitants of Panama upon the approach of Sir Henry Morgan, who sacked and laid waste that city in 1671. Before considering the details of the apparatus which Lieutenant Williams uses to detect the presence of buried metals, let us review the various steps by which his present apparatus was developed.

During the World War the great problem confronting the Allies was the menace of the German submarines. It was only natural that Lieutenant Williams became interested in the idea of detecting the presence of submarines by electrical or radio methods. Underwater microphones, called hydrophones, were available for detecting the noise made by the propellers; but if the submarines were stationary beneath the surface of the water the hydrophones were useless. By experiment it was demonstrated that metallic substances submerged in salt water acted like batteries and could be detected by magnetometers or magnetic needles, which would indicate the presence, approximate size, and approximate depth of the submerged metallic substances.

The principle underlying the use of the magnetometer is simple. It is common knowledge that the direction and intensity of the earth's magnetic field varies from place to place on the earth's surface. A compass needle does not generally point directly toward the geographical North Pole, but toward the Magnetic North. The angle of variation or *declination* is different for different localities and is usually indicated on a map or

"LIEUTENANT WILLIAMS arrived in Panama equipped only with a knowledge of the fundamental principles of searching for buried metals and a restless ambition to recover the wealth of Old Panama City," says the author. And that the quest has met with at least a measure of success is evidenced by the gold and other objects already brought to light.

Some two hundred and fifty years ago, Henry Morgan and his crew of freebooters—in January, 1671, to be exact—sacked and burned Panama City. There are fairly well authenticated legends that the inhabitants, forewarned, buried their wealth in tunnels, wells and cisterns which, today, are located among ruins covering hundreds of acres.

It is in this terrain that Lieutenant Williams is searching; not blindly, as so many predecessors did, but with the aid of an ingenious adaptation of radio principles.

chart of the locality. Similar to the declination is the *inclination* of the needle, which is the angle of dip of a needle which is free to rotate on an axis perpendicular to the earth's surface. A line connecting all points of the same declination is called an *isogonic* line; while a line connecting all points of the same inclination is called an *isoclinic* line. A third line connecting places of the same resultant magnetic intensity is called an *isodynamic* line.

By making a magnetic survey of a body of water in the vicinity of a spot where a large metallic object was supposed to be submerged, and plotting the isodynamic lines, it was possible to discover variations from the normal and to plot the approximate location of the submerged object. It is obvious that this method was too slow and exacting to be practical for wartime use, but Lieutenant

Williams became convinced of its usefulness for peacetime salvaging work and retired from the Royal Navy to take a position with a company which was salvaging ships sunken off the coast of Ireland.

In practice it was found that the difference in the magnetometer readings, rather than the actual readings of magnetic intensity and direction, was the essential information desired. An instrument similar to the magnetometer was constructed, called a magnetic variometer, which was used to measure only the variations. Two kinds of variometers were used; horizontal variometers to measure variation of declination, and vertical variometers to measure variation of inclination. Magnetic storms caused additional variation in the readings of the instruments and had to be compensated for by keeping one variometer stationary while the

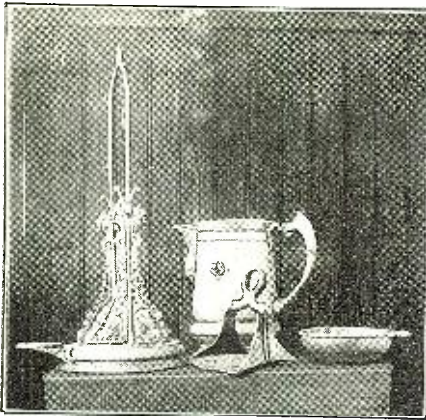

TWO SILVER VESSELS AND A BRONZE STIRRUP RECOVERED FROM THE RUINS OF OLD PANAMA CITY

AT THE RIGHT—SERVANTS LAYING OUT COINS FOR DRYING AFTER THEY HAVE BEEN RECOVERED FROM THE RUINS AND WASHED

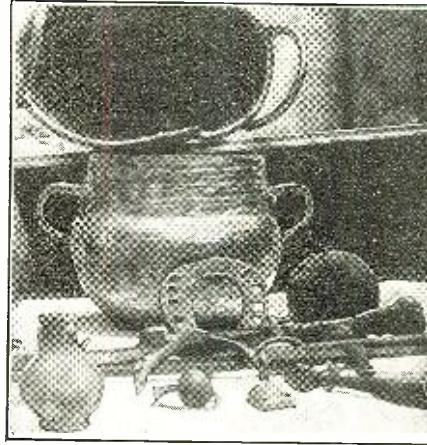

ABOVE—SOME OF THE HOUSEHOLD UTENSILS, TWO HUNDRED AND FIFTY YEARS OLD, RECOVERED FROM THE RUINS



BELOW—A VIEW OF THE APPARATUS AS IT WAS FIRST USED, WITHOUT THE TRIPOD AND LOOP WHICH WERE LATER INCORPORATED

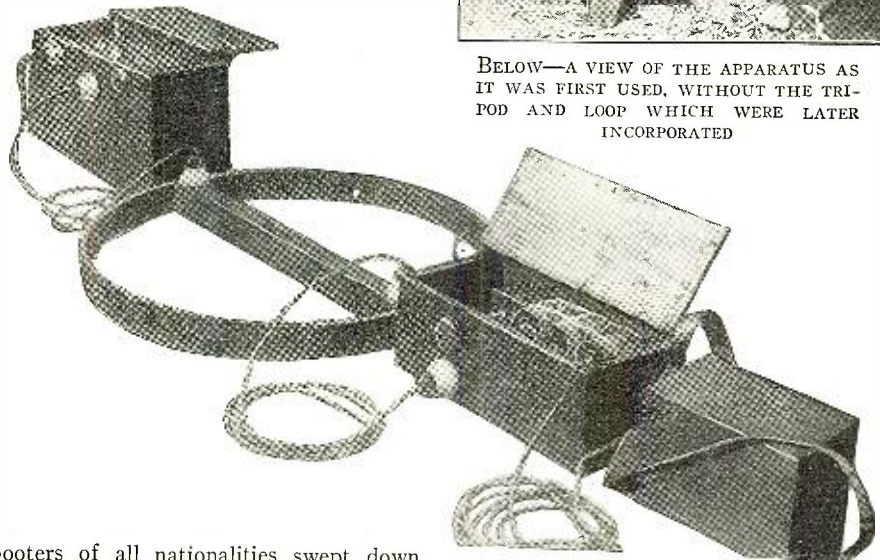

other was moved over the area being surveyed and then using the stationary variometer to indicate the variations of the earth's magnetic field. By this means it was possible to make an accurate magnetic survey of a given area and to be able to locate any region in which the magnetic lines of force were distorted because of the presence of a body of metal.

On his frequent voyages on the salvage ship Lieutenant Williams considered the various methods of locating submerged ships, and wondered why the same principle would not apply to a search for minerals or metals buried beneath the surface of the earth. The connection between sleuthing for sunken ships and hunting buried treasure or unknown mineral deposits might seem far fetched, but the basic principle in both cases is a study of the difference between the properties of a body and its surrounding substance, in one case sea water, in the other case earth.

Being a sea-faring man, Lieutenant Williams knew nothing of geology, but had read of the buried treasure of Panama City and determined to try to succeed where others had failed. More than 250 years had elapsed since the sack of the city. Soldiers, sailors, and beachcombers had all tried to locate the hidden wealth of the ruined city, but none had met with any great success.

At the height of its glory Panama City was the port of transshipment of the enormous wealth of gold, silver and jewels which poured into Spain as a result of the conquest of Peru and the spoliation of the Incan temples. It was also the point from which imports from Spain were distributed among the colonies of the new world. The city was connected with the Caribbean port of Porto Bello by a great, stone-paved highway, which was used as a thoroughfare of commerce until the construction of the trans-isthmian railroad in the middle of the last century. Over this great highway between the oceans streamed the wealth of the New World; between the two ports thousands of Indian slaves and beasts of burden carried the precious cargo for the ships which sailed in and out of the harbors of Panama City and Porto Bello.

Henry Morgan and a horde of free-

booters of all nationalities swept down upon Porto Bello one dark night, captured, looted and destroyed the port. Morgan sent word to Panama City that he would return the following year and sack that port, which was at that time a place of more than eight thousand inhabitants, with two great stone cathedrals containing a king's ransom in golden vessels and jewelled ornaments. A year later, true to his threat, Morgan collected a new army of buccaneers and attacked Panama City at sunrise on January 28, 1671.

The story of the battle is an interesting one, but we are more interested in ascertaining whether or not there was any historic basis for the legend of buried treasure. The buccaneers sacked the town and during the confusion some one set fire to the town, the majority of houses of which were made of weed with thatched roofs. Before the dawn of another day Panama City was a heap of ashes, with here and there the remains of a stone building. In describing the wealth of the city the historian, John Esquemeling, who was one of the band of buccaneers which sacked the city, said:

"There belonged to this city (which is also the head of a bishopric) eight mon-

asteries, whereof seven were for men and one for women, two stately churches and one hospital. The churches and monasteries were all richly adorned with altarpieces and paintings, huge quantity of things; all which the ecclesiastics had hidden and concealed. Besides which ornaments, here were to be seen two thousand houses of magnificent and prodigious building, being all or the greatest part inhabited by merchants of that country, who were vastly rich. For the rest of the inhabitants of lesser quality and tradesmen, this city contained five thousand houses more."

All accounts of the sacking of Panama agree thus far, but there are two theories in regard to what became of the wealth of the two cathedrals and the personal possessions of the inhabitants. One story is that all of the wealth of the city was sent out on a sailing vessel which carried the nuns from the convents and other non-combatants, on a voyage from which no one ever returned. The other story is that the citizens were not afraid of capture by the freebooters and merely buried their wealth in tunnels, wells, and



A SHIELD OF BEATEN GOLD AND NUMEROUS SMALL PIECES OF GOLD AND SILVER JEWELRY WHICH WERE RECOVERED FROM AN INDIAN GRAVE BY LIEUTENANT WILLIAMS

FIG. 3. AT THE RIGHT—LINES OF MINIMUM AUDIBILITY BETWEEN THE AREA OF TWO GROUNDED ELECTRODES. DISTORTION OF THE EQUIPOTENTIALS INDICATES THE PRESENCE OF A METALLIC SUBSTANCE.

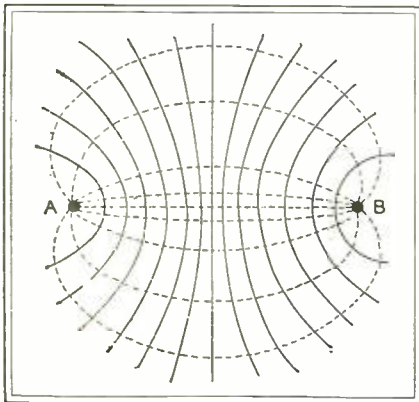

FIG. 1. BETWEEN THE TWO GROUNDED ELECTRODES, "A" AND "B," THE LINES OF CURRENT FLOW ARE SHOWN DOTTED; THE EQUIPOTENTIALS IN AN UNDISTURBED AREA ARE SHOWN AS SYMMETRICAL, SOLID LINES

FIG. 2. BELOW—THE LINES OF CURRENT FLOW INTO THE AREA OF THE BURIED SUBSTANCE WHILE THE EQUIPOTENTIAL LINES SPREAD AWAY FROM IT AND ARE NOT SYMMETRICAL

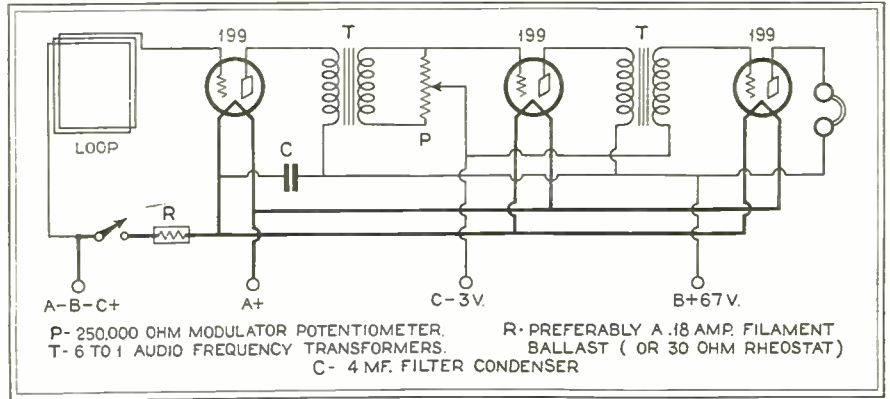
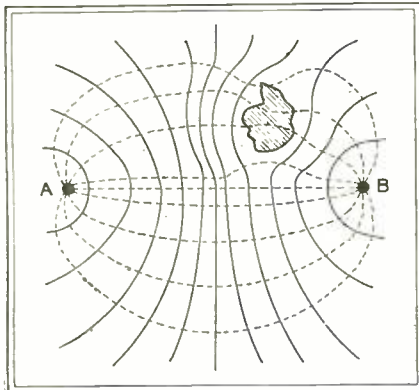
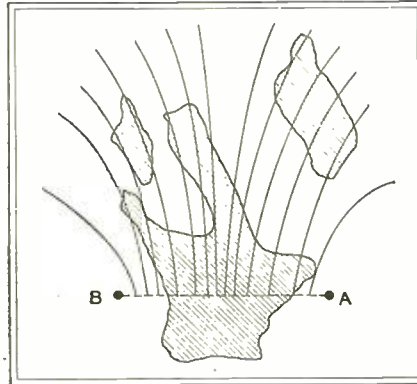

FIG. 4. THE RECEIVING CIRCUIT FOR THE WILLIAMS METAL LOCATER IS SHOWN ABOVE



for buried treasure. He accordingly selected a clearing in the jungle and proceeded to experiment with a galvanometer, a few dry cells and hollow copper rods, until he evolved a method of exploration which was sensitive and apparently sound.

The principle of this method is made clear by Figs. 1 and 2. In Fig. 1 we have an illustration of the current lines flowing between the two ground-rods, A and B, as dotted curves. The solid lines are equi-potential lines in an undisturbed area. In Fig. 2 the metallic body causes the lines of current flow to crowd into the metallic body, while the equipotential lines spread outward and are studied by means of a galvanometer connected to two rods.

This method was tried near the ruins and was satisfactory in detecting fairly large metallic objects but was not sensitive enough to satisfy the hungry treasure-hunter. He therefore proceeded to construct an apparatus which would embody the same principle and yet have a stronger transmitter and more sensitive receiver. As a result he evolved the apparatus which is in successful use today.

Let us imagine ourselves motoring from the new Panama City to the old ruins. We ride through flat, monotonous savannas for several miles, until the road branches sharply to the right and brings us to the ruins of Old Panama.

The first object which we see is the old, nearly ruined bridge over which Sir Henry Morgan led his cut-throats when he sacked the city. Beyond the road are several great ruins overgrown with ivy and other tropical vines, while over all, dominating the scene, is the tower of the church of San Anastasia, rising like a monument over the city of the dead Dons. A few yards beyond the tower the last remnant of an old seawall marks all that is left of what was once a walled fortress which guarded the city from the sea. Nearby we find the dark, damp vaults in which was kept the vast treasure of the Incas and Aztecs while awaiting the treasure trains of mules, slaves and soldiers to take it over the Gold Road to the harbor of Porto Bello.

Today the vaults are empty. No longer do the damp flagstones ring to the tread of men in armor; no longer are the cells filled from floor to arched ceiling with

cisterns, where it could be easily recovered when the invaders were repulsed.

Of the two theories, the former had the greater number of adherents until recent years. The discovery of the great golden altar of the Church of San Jose revived the legend of the existence of a life-sized statue of the Virgin, made of gold and silver, with other precious church relics hidden at the same time as the golden altar. A few Canal employees and soldiers stationed on the isthmus did a little desultory digging, but, beyond finding a few pieces of eight and an old anchor, nothing of importance was found until the arrival of Lieutenant Williams.

Lieutenant Williams arrived in Panama equipped only with a knowledge of the fundamental principles of searching for buried metals and a restless ambition to recover the wealth of Old Panama City. At first he encountered nothing but apathy from the natives and the jeers of the English and American residents. By chance he became acquainted with politicians who secured for him a government grant, allowing him the exclusive right to search for buried treasure if he would accept three-quarters of the value of whatever he unearthed and give the government the other quarter. The charter provided that any objects of artistic or historical value were to be placed in the National Museum and the explorer paid according to their weight.

By means of a magnetic variometer a survey was made of the ground in the neighborhood of the old ruins, but the results were not satisfactory for some reason or other, and Lieutenant Williams decided that perhaps some other method might be more satisfactory in searching

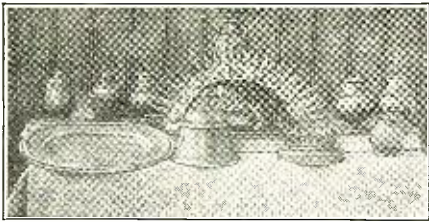

GOLDEN CHURCH VESSELS FROM THE RUINS OF OLD PANAMA CITY

chests of dull gold and barrels of gems torn from the tortured bodies of Indian rulers. Today the floors are knee-deep in dirt; scorpions and centipedes crawl where the Conquistadors once trod. What were once doors are but splinters of wood suspended by rusty hinges. Snakes and bats hold dominion where priests and soldiers once stored their wealth.

It was to such a place that Lieutenant Williams brought his apparatus to search for buried treasure. He realized the futility of digging into every vault and well in the hundreds of acres of ruins, and knew that unless his apparatus could reveal the presence of buried metal in considerable quantities, his time spent in experimentation would be useless.

Two electrodes, made of three-foot lengths of zinc-coated iron pipe, two inches in diameter, with copper wires well soldered at the upper ends, were placed in the ground to be explored. They were connected to a generator having a frequency of 500 cycles (1000 impulses per second).

The receiver cabinet is suspended from a tripod and the receiving coil is secured to the tripod in a swivel frame by gimbles, so that it can be swung in either a horizontal or a vertical plane. The loop of the receiving coil consists of a wooden frame $2\frac{1}{4}$ feet across, on which are wound approximately 500 turns of No. 24 B&S gauge, double silk-covered copper wire, and so attached to the base that the azimuth of the coil can be read. The tripod is leveled by means of a plumb-bob before taking each reading.

From the accompanying hook-up (Fig. 4) it can be seen that four UV199 tubes

BELOW—THE ANCIENT BRIDGE OVER WHICH MORGAN LED HIS BUCCANEERS TO SACK AND BURN THE CITY

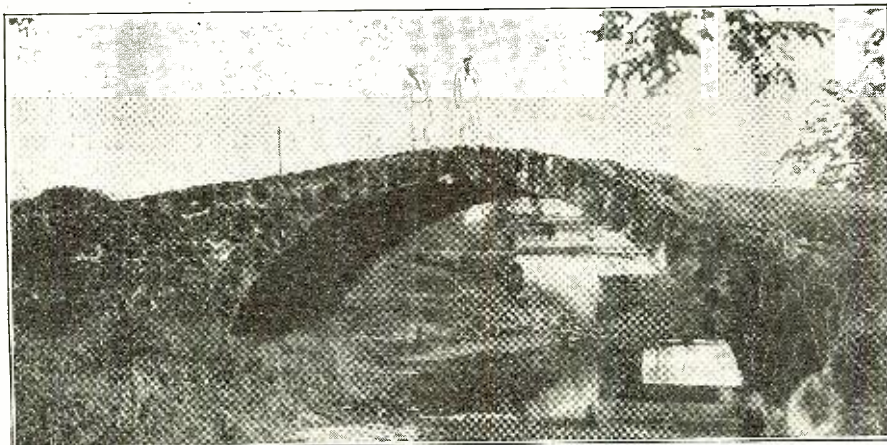

ONE OF THE STATUES FOUND IN THE RUINS OF AN OLD CHURCH IN PANAMA CITY IS SHOWN AT THE LEFT



ONE OF THE WELLS, ON WHICH THE TROPICAL GROWTHS HAVE ENCREACHED TO A CONSIDERABLE EXTENT. IT WAS IN SUCH PLACES AS THESE THAT BURIED TREASURE WAS RECOVERED

and two high-ratio audio transformers are used. The plate potentials are obtained from ordinary "B" batteries and the filament current from a small storage battery. A 250,000-ohm modulator, P, is employed to regulate the signal volume. Headphones are employed for reception.

In taking readings, the receiving coil is rotated into such a position that a minimum sound is heard in the phones. This is sometimes called a "null" method and amounts to the same thing as a search for the direction of the field. The intensity of the disturbance indicates roughly the quantity of the metalliferous substance and is found by turning the receiving coil 90° from its position of minimum sound and measuring the strength of the current by a galvanometer. Phase difference is difficult to interpret, as it is influenced both by the distance and the depth of the buried metal. By plotting the silence points, equi-potential lines are drawn and compared with a plan of estimated normal equi-potential lines. Fig. 3 illustrates the appearance of a plotted area in which a metallic deposit is present.

The accompanying illustrations give a fair idea of the variety of treasure which

has been recovered by Lieutenant Williams. Gold and silver candlesticks, platters, incense pots, sanctuary lamps, necklaces, bracelets and rings have been found in wells and cisterns. "Pieces of eight" were found in earthenware, caked with dirt, and had to be broken open and soaked in water in order to extract the coins. Personal effects such as keys, Toledo swords, and daggers were found mixed indiscriminately with copper kettles, bronze stirrups, and andirons. Of course, the most valuable finds were the statues and altar pieces buried by the priests, but the coins and other common objects have a historical value. The objects of archeological or historical value are kept in the vaults of the National Bank of Panama and on display in the National Museum.

Lieutenant Williams still expects to find chests of gold ingots which were hidden by the Treasurer of Old Panama in the tunnels connecting the monasteries and churches. The discovery of a single such chest or of the fabulous, life-size golden statue of the Virgin would enrich the inventor far beyond his wildest dreams and enable him to finance his proposed expedition to "Cocos Island," the scene of Robert Louis Stevenson's "Treasure Island."

These searches, the one now going on at Panama, and that contemplated at Cocos Island, are, of course, only two possible applications of a device which seems to hold rather interesting possibilities.

Which Power Tube Shall I Use?

What Undistorted Power Output Means in Terms of Volume

By JAMES MARTIN

THE importance of selecting the right power tube for use in a power amplifier cannot be overstressed. When an experimenter undertakes the building of a power amplifier he wants his work to result in the construction of a unit that will, in every way, justify the efforts expended on it. The frequent construction of amplifiers poorly designed for the use to which they are to be put bears sufficient testimony to the lack of consideration sometimes given to the problem.

The primary function of a power amplifier is to supply undistorted power to a loud speaker, in amounts sufficient so that the loud speaker can give distortionless reproduction at the volume level preferred by the listener. Power tubes and power amplifiers are essential for satisfactory reproduction because of the low efficiency of loud speakers, this low efficiency necessitating that the loud speaker be supplied with perhaps fifty times as much power as will be finally radiated as sound. If the power tube has not sufficient capacity to supply to the loud speaker the required amount of undistorted power we either have to operate the loud speaker at a volume level lower than we desire (so that less power is drawn from the tube) or we have to permit the power tube to overload, under which condition serious distortion is pro-

duced. The type of distortion produced by an overloaded tube is especially obnoxious to any but the most insensitive ear.

There are now available to the home constructor the following types of power tubes, the 112A, the 171A, the 210, the 250 and the new type 245. All of these tubes can be used singly or in push-pull and there are consequently ten possible combinations of power tubes that can be and are used in power amplifiers. The

important but rather difficult problem is to determine what factors govern the use of one particular tube or combination of tubes rather than some other tube or combination. And it is the purpose of this article to endeavor to answer this problem.

Comparing the Available Power Tubes

In deciding which power tube to use

TABLE I

Arrangement No.	Power Output in Watts	Type of Tube	Single or Push-pull	Plate Voltage Required
1	.120	112A	Single	135
2	.195	112A	Single	157
3	.330	171A	Single	135
4	.360	112A	Push-pull	135
5	.600	112A	Push-pull	157
6	.600	210	Single	300
7	.700	171A	Single	180
8	.750	245	Single	180
9	1.0	171A	Push-pull	135
10	1.5	210	Single	425
11	1.5	250	Single	300
12	1.6	245	Single	250
13	2.1	171A	Push-pull	180
14	2.25	245	Push-pull	180
15	3.2	250	Single	400
16	4.5	210	Push-pull	425
17	4.5	250	Push-pull	300
18	4.6	250	Single	450
19	4.8	245	Push-pull	250
20	9.6	250	Push-pull	400
21	13.8	250	Push-pull	450

THE NATIONAL COMPANY'S PUSH-PULL POWER AMPLIFIER. IT EMPLOYS TWO 245'S IN THE OUTPUT STAGE AND AN A.C.-OPERATED FIRST AUDIO STAGE

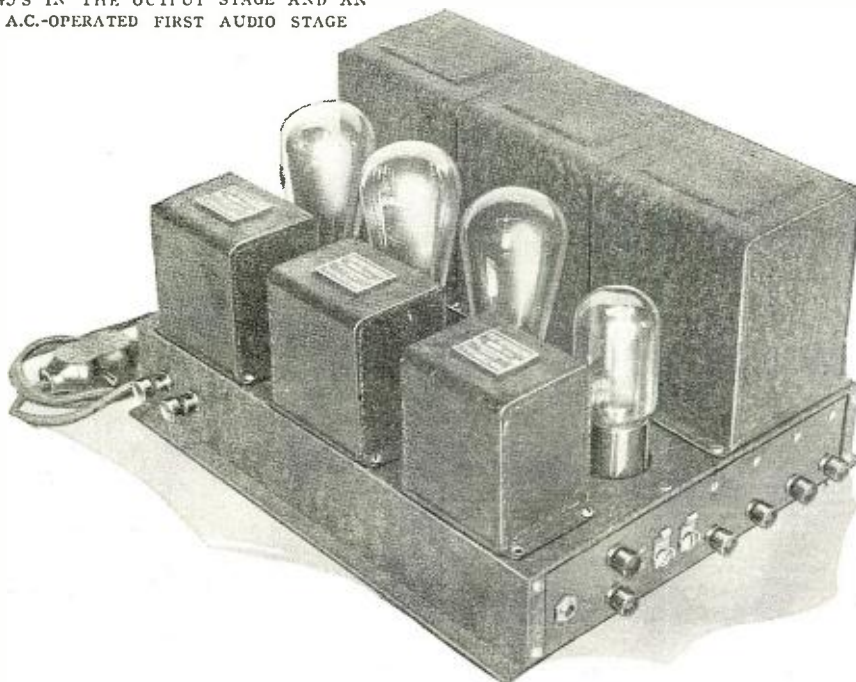

the first point to be determined is how they compare with regard to power output. We have therefore listed in Table I, and shown graphically in Fig. 1, all of the tubes and their combinations and indicated their power output at the various voltages at which they are commonly used. It should be noted that the table has been arranged in order of power output, the tube supplying the least power appearing first and the tube supplying the most power appearing last. At the top of the table we find the 112A from which an output of 0.120 watts is obtained at a plate voltage of 135 volts. The last line shows a power of 13.8 watts supplied by two type 250 tubes operated in push-pull at a plate voltage of 450 volts. In all cases in preparing this table we have assumed that the power output to be obtained from two tubes in push-pull is equal to three times that obtainable from a single tube of the same type operated at the same plate voltage. Therefore 0.7 watts are supplied by a single 171A and three times as much or 2.1 watts are supplied by two 171A's in push-pull. That this assumption that tubes in push-pull



FERRANTI'S 245 PUSH-PULL POWER AMPLIFIER

give about three times the output of a single tube is approximately correct will be shown by some data to be given later in this article.

Since Table 1 is arranged in order of power output it is well adapted to aid in the determination of what tube or combination of tubes can be used to give any particular output. We feel that if readers will devote considerable thought to the data given in the table a very clear idea will be had of the relative positions of the various power tubes from the standpoint of relative power output.

How to Use the Table

An example will perhaps serve to make perfectly clear the usefulness of the table. As an example, suppose that you, the reader, desired to construct a power amplifier capable of supplying up to three watts of power. Since the amplifier must supply at least three watts we can neglect from consideration all arrangements up to No. 15 in Table 1. The latter arrangement will supply 3.2 watts, slightly more power than we require. But since it is of no particular disadvantage to have the maximum possible output of our amplifier somewhat greater than the required three watts the question naturally arises whether it is not possible that some other arrangement perhaps supplying more power than is required might nevertheless be somewhat more simply and cheaply constructed. One of the most important criterions, by which we can compare several arrangements, all capable of supplying sufficient power to meet the requirements, is the plate voltage required for the operation of the tubes. We should note therefore that arrangement No. 15, which is the first one supplying the necessary three watts or over, requires the use of a single type 250 tube operated at a plate voltage of 400 volts. Arrangement No. 16 requires the use of two type 210 tubes in push-pull operated at 425 volts and it certainly is not to be preferred in comparison with No. 15, which requires only one 250 tube and 400 plate volts. The only arrangement that requires consideration is No. 19, in which are used two type 245 tubes in push-pull at a plate voltage of 250

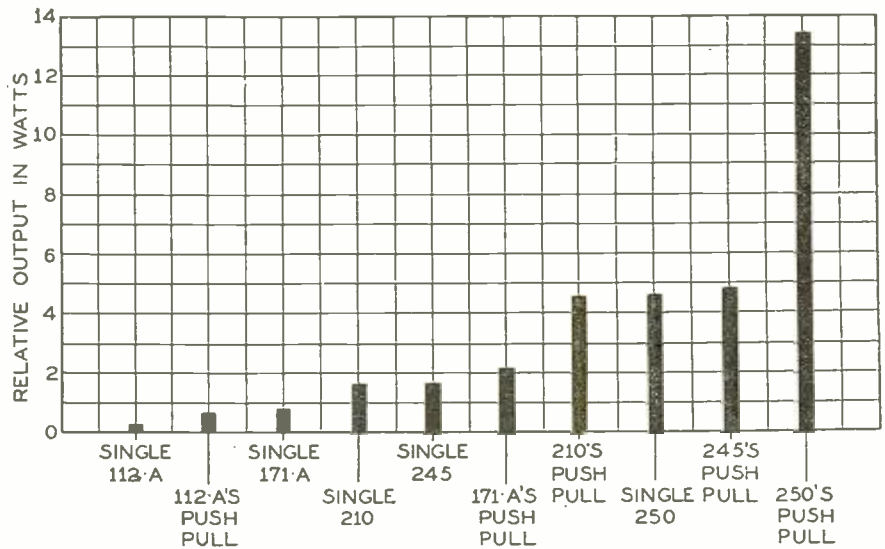

FIG. 1—THIS CHART ILLUSTRATES GRAPHICALLY THE DIFFERENCE IN POWER OUTPUT OF THE VARIOUS TUBES SINGLY AND IN PUSH-PULL AT THE LEFT IS A SINGLE 112A WITH AN OUTPUT OF 195 MILLIWATTS (0.195 WATTS) AND AT THE RIGHT IS INDICATED THE OUTPUT OF TWO 250 TUBES IN PUSH-PULL (13.8 WATTS)

volts. Because of the comparatively low plate voltage required by this arrangement it is possible to save considerable expense in the construction of the power supply for the amplifier and also generally speaking, there is much less danger of filter condenser breakdown in a power unit supplying 250 volts than in one supplying 400 volts. Also 250 volts is much less dangerous in case of accidental shock than is 400 volts. These facts would probably make us decide to construct an amplifier using arrangement No. 19 consisting of two 245 tubes in push-pull rather than arrangement No. 15 requiring the use of a single 250 tube at 400 volts.

In discussing the above problem we have actually been determining the "best" amplifier to build when one requires an output of three watts. It appears that there ought to be a "best" arrangement for other power outputs. That is, if we require an output of a half watt, or two watts or four watts there ought to be, in each case, some one arrangement gener-

ally superior to others. If we can determine what these preferred arrangements are we ought to be able to eliminate a number of the possibilities suggested in Table 1 and make easier the decision of what arrangement will be used.

Now for some time we have been talking of various power outputs. It will perhaps be worth while to translate "power output" into terms of volume of sound. The writer feels that the following figures are about average. Power outputs up to about 0.3 or 0.5 watts will give fairly low room volume; about 1.5 watts gives very good room volume; up to about 3 watts gives loud room volume and five to ten watts gives auditorium volume.

Let us first assume that one should never build a power amplifier to give an

output of less than 0.3 watts. Now let us determine the best arrangement to use for outputs of 0.3 to 0.5 watts, 0.5 to 1.0 watts, 1.0 to 1.5 watts, 1.5 to 2.0 watts, 2 to 3 watts, 3 to 5 watts, and finally 5 to 10 watts. From an examination of Table 1 it would appear that the following choices should be made:

For outputs of 0.3 to 0.5 watts, use a single 171A tube since this tube with 180 volts applied to its plate can easily supply somewhat more than 0.5 watts.

A HOME-BUILT TYPE OF PUSH-PULL POWER AMPLIFIER. A PAIR OF 171 TUBES IS USED IN THE POWER STAGE

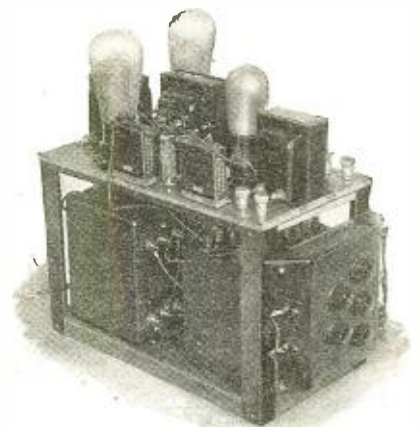

For outputs of 0.5 to 1.0 watts, use 171A's in push-pull with 135 volts on the plate. A second possibility for this range of output is to use a single 245 tube with about 200 volts on its plate.

For outputs of 1.0 to 1.5 watts, use a single 245 with 250 volts on the plate.

For outputs of 1.5 to 2.0 watts, use 171A's in push-pull.

For outputs of 2.0 to 3.0 watts, use a pair of 245 tubes in push-pull with somewhat less than 250 volts on the plates.

For outputs of 3 to 5 watts, use 245's in push-pull with 250 volts on the plates.

For higher outputs than 5 watts, use 250's in push-pull.

It will be noted from the above that 245 tubes in push-pull is evidently the best arrangement for use between the limits of 2 watts and 5 watts. Therefore, if we condense the above suggestion to this extent and rearrange them in table form the following results are obtained.

TABLE II

Watts Output	Best arrangement to use
0.5 or less	One 171A at 180 volts
0.5 to 1	171A's in push-pull with 135 volts; or a single 245 with about 200 volts on the plate.
1 to 1.5	Single 245 at 250 volts
1.5 to 2	171A's in push-pull at 180 volts
2 to 5	245 tubes in push-pull
Higher powers	250 tubes in push-pull

The "210" Becomes Obsolete

There are several surprising things about this table. The first interesting

FIG. 2—TWO OF THE NEW TYPE 245 TUBES CAN BE USED IN A PUSH-PULL AMPLIFIER TO SUPPLY UP TO APPROXIMATELY FIVE WATTS OF POWER TO A LOUD SPEAKER. AN AMPLIFIER OF THIS TYPE HAS THE ADVANTAGE THAT COMPARATIVELY LARGE AMOUNTS OF POWER CAN BE OBTAINED WITH ONLY MODERATELY HIGH PLATE VOLTAGES. AN AMPLIFIER OF THIS TYPE IS IDEAL FOR HOME USE

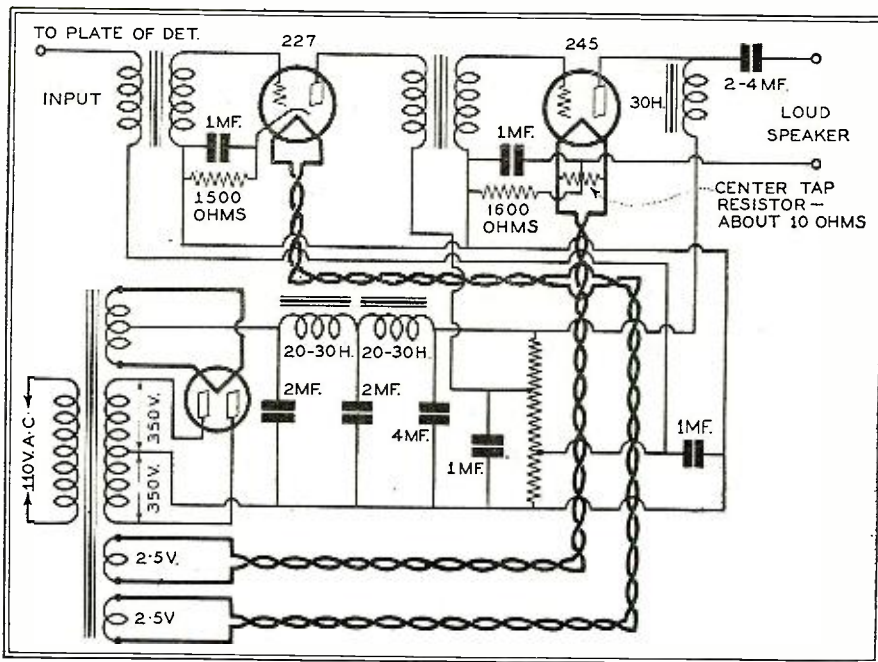
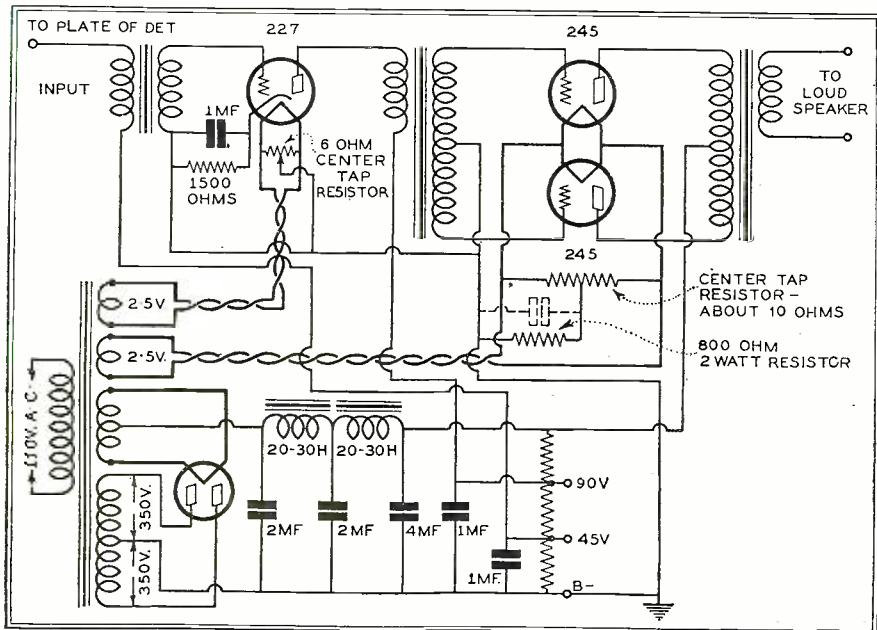

FIG. 3—THIS DIAGRAM GIVES THE CIRCUIT OF A TWO-STAGE TRANSFORMER-COUPLED AMPLIFIER USING A TYPE 227 A.C. TUBE IN THE FIRST STAGE AND A SINGLE TYPE 245 POWER TUBE IN THE OUTPUT STAGE. PLATE VOLTAGES ARE SUPPLIED BY A TYPE 280 FULL-WAVE RECTIFIER

thing to note is that the 210 type tube does not appear at all. The 210 tube is capable of supplying approximately 1.5 watts at a plate voltage of 425 volts, whereas a single type 245 tube can supply 1.6 watts with only 250 volts. For this reason it hardly seems advisable to use a 210 with all the difficulties and expense of constructing a high voltage plate supply device when equivalent power output can be had from a single 245 with only 250 volts. It appears to the writer, then, that the 210 tube has practically outlived its usefulness as a power output tube in conjunction with radio receivers:

A second interesting fact evident from Table II is that fairly low voltages (250

volts or less) can be used to obtain various powers up to a maximum of 5 watts.

Another interesting point is that we have limited the really useful power tubes to the 171A, the 245 and the 250. The 210 does not appear for reasons given in a preceding paragraph. Regarding the reasons for the non-appearance of the 112A it will be worth while to digress for a moment.

Where the 112A Should Be Used

Although we have not so stated specifically in this article one naturally thinks of power amplifiers as being a.c. operated devices. On the assumption that a.c. is available there is no reason to construct a complete a.c. operated amplifier and B supply for a single 112A or for two of them in push-pull. We might just as well use a single 171A. However, in those cases where a.c. is not available and the power tube must therefore be operated from dry batteries, the 112A may be used singly or in push-pull to supply about 0.6 watts to a loud speaker.

Recapitulating

We have reached a point in our discussion of power tubes where it is perhaps advisable to stop for a moment and consider what has gone before. Up to this point we have reached certain conclusions regarding tubes and plate voltages which must be used to obtain a certain amount of power output. These conclusions were summarized in Table II. As yet, however, we have not completely answered the question of what tube and arrangement should be used. We will now begin the discussion of other aspects of the problem, after which we will be able to reach some final conclusions. The reader will appreciate that in this article we are endeavoring to indicate as clearly as possible the reasons for all the statements which we make. We could in much less space set down our conclusions without bothering about reasons but that would in no way increase the knowledge of the reader—and every article should in some way help to add to his fund of knowledge.

A mere collection of facts no more constitute knowledge than does a collection of paints constitute painting.

Push-Pull Versus Single Stage Amplification

Into an article devoted to a discussion of power amplifiers there naturally enters the question of the comparative merits of a single tube stage in comparison with a push-pull amplifier. First, let us ask, why is push-pull amplification used? And the answer is, for a variety of reasons, among which are increased power output, less hum with a.c. operation, and less distortion. The last reason is one of the most important. When a single tube is used as an amplifier it produces some distortion due to "curvature of the tube's characteristic." It is beyond the scope of this article to go into a discussion of how such distortion takes place, and we will therefore limit our remarks to an explanation of what the distortion is and how it compares in magnitude in single and push-pull arrangements.

The distortion due to the curvature of the tube's characteristic takes the form of the introduction of new frequencies—harmonics they are called—into the original signal fed to the tube. In other words if we supply to the tube a pure, that is undistorted, 1,000 cycle note we would find that in the output of the tube there would appear some 1,000 cycle audio frequency power and in addition a small amount of power at 2,000 cycles, 3,000 cycles, 4,000 cycles and so on. These higher frequencies are the "harmonics" and the smaller they are in comparison with the fundamental (the pure 1,000 cycle note) the smaller is the distortion. How does this distortion compare in single and in push-pull circuits?

TABLE III

Power in Watts being delivered by the tube	Percentage of total harmonic distortion	
	Single tube	Tubes in push-pull
0.1	2.5	0.5
0.5	4.5	0.7
0.8	7.0	0.8
1.0	8.0	0.9
2.0	20.0	2.0
3.0	very high	4.5
4.0		7.0
6.0		10.0

(245 Tubes)

TABLE IV

Filament Voltage	Filament Current	Plate Voltage	Plate Current	Negative Grid Bias	Amplification Factor	Plate Impedance (approx.)	Watts Power Output
2.5 a.c.	1.5 a.c.	180	26	33	3.5	2,000	0.75
		250	32	50	3.5	2,000	1.6

TABLE V

Plate voltage	Power Output in Watts				
	Type of Tube	Type of Tube	Type of Tube	Type of Tube	Type of Tube
	112A	171A	210	245	250
135	.120	.33			
180		.7	.150	.75	
250			.35	1.6	.9
400			1.3		3.2
450					4.6

The answer to this question was given quite completely in an article by F. C. Willis and L. E. Melhuish in one of the past issues of the Bell System Technical Journal. The results of the tests by these engineers were given in the form of curves but for ease of comparison are here given in tabular form. See Table III.

The specific problem which the telephone engineers set out to solve was to determine how much harmonic distortion was produced by a single tube, how much by the same type of tube in push-pull, and how this distortion varied with the load on the tube.

Now if we decide that the maximum permissible harmonic output should be five per cent (the figure generally used by engineers in rating power tubes) then the maximum the single tube in the above tests could handle was about 0.6 or 0.7 watts. *At the same output the two tubes in push-pull had only seven-tenths of one per cent harmonic!* The two tubes in push-pull could deliver up to about three watts before the harmonic content reached five per cent. Also to be noted from the above figures is the fact that the harmonic output from the two tubes
(Continued on page 178)

FIG. 4—JUST ANOTHER WAY OF SHOWING THE RELATIVE VALUES OF UNDISTORTED OUTPUT OBTAINABLE FROM VARIOUS COMBINATIONS OF AVAILABLE POWER TUBES

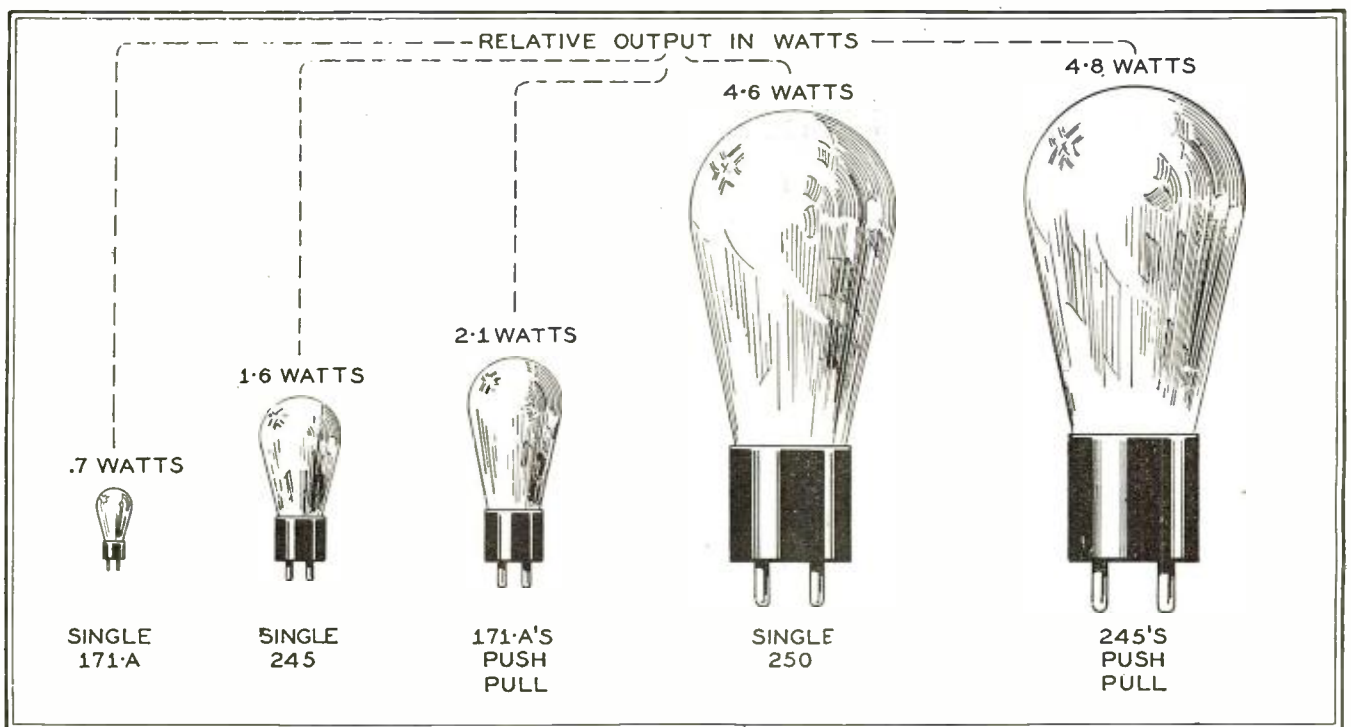

The Realization of an Aviation-Radio Idea

Station WRNY Embarks on a Forward-Looking Program of Service

By LLOYD JACQUET

EVERY human achievement began with an idea. It was carried through by vision. There are a number of famous instances that prove this thesis: Ford's cheap transportation; Bell's voice communication system; Marconi's wireless exchange of messages, in the modern era.

Ten years ago, Walter Lemmon was an officer aboard the U. S. S. *George Washington*, a distinguished ship of the U. S. Navy, who had as a passenger no less a distinguished personage than President Wilson. The President was making his second, and, as it turned out, his last trip to Europe.

As the Presidential ship, the U. S. S. *George Washington* was of course equipped with every possible convenience known to science to make life on board durable, pleasant, and without monotony.

Of interest to Lieut. Lemmon, as well as to the history student of radio, the naval ship carried probably the most pretentious and complete radio apparatus then aboard any ship of the Navy. It had been agreed by officials in Washington before the President's departure, that every effort should be made to have the Chief Executive in constant touch with Washington. So many things of intimate national importance were then taking place, which would have a bearing on the international situation which Wilson was even at that time com-

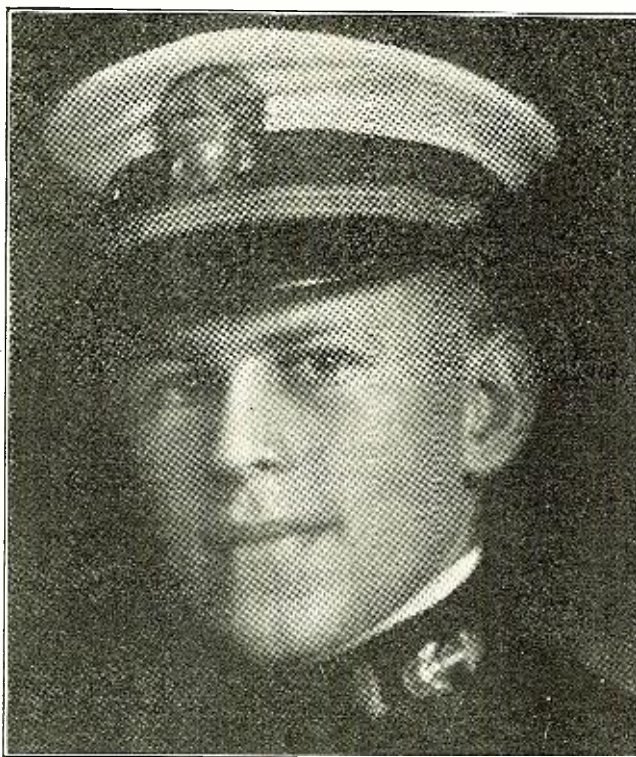

WALTER LEMMON, one-time Naval Lieutenant aboard the *U. S. S. George Washington* when she carried the late President Wilson on his last trip to Europe, and now general manager of radio station WRNY.

ing in closer contact with, that immediate and positive communication from the ship with the executive headquarters was of prime importance.

This was arranged by having the Navy install on board four transmitters, the most powerful of which was a 25 kw. arc installation. Under the direction of Henry Leeb, radio officer, the Navy Standard 2 kw. spark set, the small CW-936 radiophone sending-receiving group, and the emergency transmitter were duly placed on board.

Obviously, there wasn't much room on board for the radio personnel, after the cargo of radio apparatus was installed. It was still necessary to locate the receiving systems, and those sets were located as far aft as possible, to remove them from the influence of the transmitters. Since long distance radio communication was conducted on long waves, from 8,000 to 13,500, the receivers were of the very latest type and design.

A special transmitter, about which little has ever been said, was the high power wireless telephone transmitter, installed for the use of the President. It was thought that he might want to speak directly with his officials and friends in the

THE S. S. GEORGE WASHINGTON, ON WHICH MUCH RADIO PIONEERING WAS DONE TEN YEARS AGO

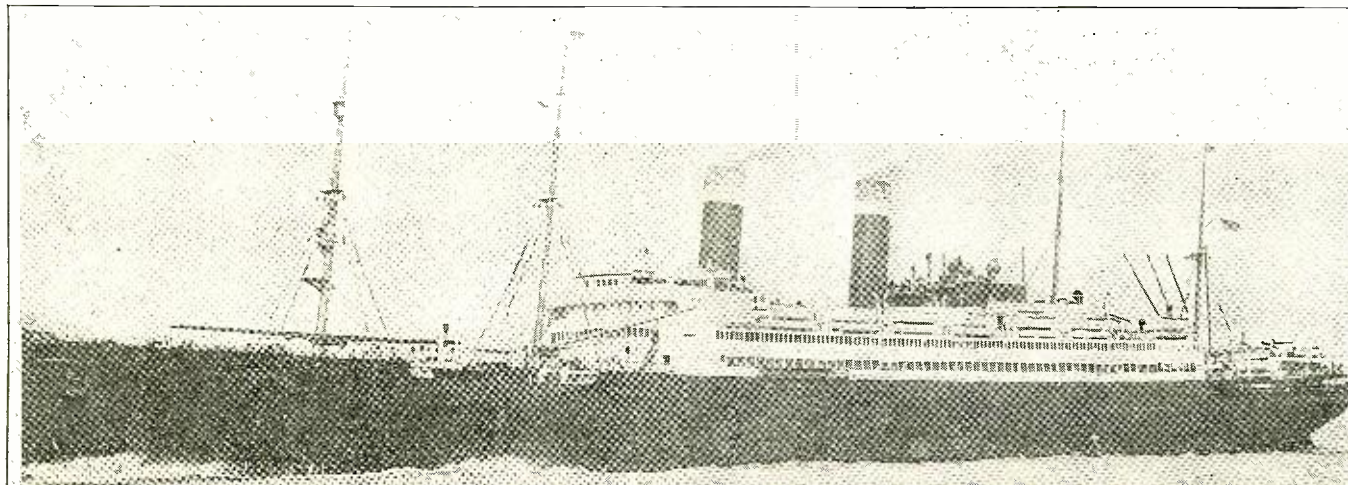

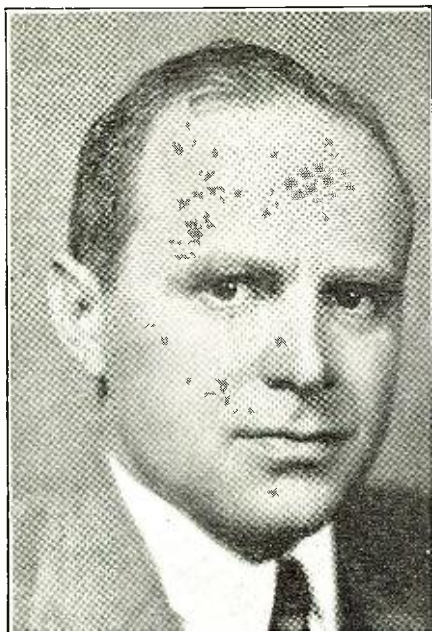

CHESTER W. CUTHELL, PRESIDENT OF AVIATION BROADCASTING CORPORATION

United States, while on his voyage. Actually, the President used this extensive and interesting installation but a very few times.

Transmission was accomplished by the use of twelve 250-watt tubes for the power amplifier, which was excited by the output from a half-kilowatt master oscillator, in turn modulated by two 25-watt tubes. The entire transmitter had an output of about two and a half kilowatts in the antenna, transmitting on 1,800 meters. It took 40 days to design, build, and install this very special equipment, after the President's wishes were known regarding the radio-telephoning to shore. Lieut. Lemmon arranged to take with him two experts from the General Electric Company to test and observe this special equipment, which later formed the basis for all navy tube sets.

Considering the lack of data, the impossibility of securing water-cooled tubes of greater capacity than the air-cooled 250-watters, and considering also that material as well as men were not readily available as might be imagined, and think that all this happened in 1919. You have a real picture of accomplishment.

The cruise of the *U. S. S. George Washington* was a diplomatic success, as every one knows. Less trickled out concerning the radio end of things, however.

One of the big successes of the radio installation was, aside from the master handling of thousands of words of confidential, semi-confidential and personal messages, the entertainment of the President and his party, by special programs that were transmitted from the high-power station at Belmar, N. J. This was Walter Lemmon's job. He had to pick up the transmissions, amplify them, and distribute them throughout the ship, to be tapped at a point most convenient to the President's proximity. Such service was to be available instantly, and in spite of the fact that the various transmitters on board might be then engaged in their regular business of sending and receiving messages.

Walter Lemmon recalls that it was while the ship was lying in Brest Harbor, France, and the special receiver was amplifying broadcasts originating from American shores, that the idea of international rebroadcasting of programs came.

With a summer condition, increased static, and weak signals, the idea of rebroadcasting had to be abandoned. However, the ship's band concerts were transmitted, and picked up in various capitals of Europe, where arrangements had been made to tune in the *U. S. S. George Washington*. Major Edwin H. Armstrong, of regenerative fame, then in Paris doing research work for the Army, was among those who arranged the receiving end of these concerts. It was then that the idea of international broadcasting occurred to Walter Lemmon.

It wasn't until a long time after, in fact more than ten years, that he was to carry out the idea he conceived in Brest Harbor.



C. M. KEYES, PRESIDENT OF NATIONAL AIR TRANSPORT

Now, Lemmon is the general manager of the Aviation Broadcasting Corporation's station WRNY. His ambitious plans, as revealed recently, when four high frequency channels were granted WRNY's short-wave transmitter, W2XAL, for rebroadcasting experiments. For the time being, Mr. Lemmon explained, the transmitter will remain in its present location, using the same power for experimental purposes.

It was revealed also that Robert M. Marriott, an old pioneer in the field of radio and the first president of the Institute of Radio Engineers, was retained by Mr. Lemmon as consultant and had worked out the details of the plans for the transmission, and the reception of American programs to foreign countries for rebroadcasting purposes.

Based on the sound idea that American industrialists need more good will in South America if they are to sell more of their

products there, and feeling that the good word can best be carried on the swift and efficient waves of radio, Mr. Lemmon has already established contacts, through his associates, for the transmission of programs to Chili, Peru, Argentina and Brazil.

Programs with an especially written good will appeal for the Latin-American programs sponsored by American firms interested in those markets will be sent via the short-wave set to a powerful, well located broadcasting station (for rebroadcasting) in each one of those countries. Several of those stations are now in operation, others are being built.

By the time this is printed, several young American radio engineers will be on their way down to the cities picked out, to install the specially designed and built pick-up receivers that will be used to rebroadcast the American-made programs. These special receivers will feed into the powerful South American broadcasters the short-wave messages that will be sent them by W2XAL, in Coytesville, N. J. At first, the reception and rebroadcasting will be supervised by the engineers who accompany the pick-up receivers. This will insure results which will be of the finest, thinks Mr. Lemmon, since the engineers will be acquainted with the local conditions attending the transmission, and can better understand the problem in reception as a result.

Negotiations have been opened also with Italy, France, and China. If the assistance which those countries offer the general manager of WRNY mean anything, it is possible that W2XAL's signals will be radiated by rebound out of Rome, and through the Eiffel Tower's huge transmitter, as well as from the oriental installation in Shanghai, China. Walter Lemmon's dream of international broadcasting seems well on the way to realization!

To build up a good background of broadcasting for the day when all the technical arrangements will be complete

(Continued on page 184)

G. C. WILLSON, WHO HAS LENT HIS ACTIVE SUPPORT TO THE AVIATION-RADIO PROJECT



The Radio Forum

*A Meeting Place for Experimenter, Serviceman
and Short-Wave Enthusiast*

The Experimenter

Intermediate "B" Voltage from the Power Pack

The majority of 281-210 power amplifier units are constructed with transformers and choke coils of husky enough design to supply the added current necessary for the "B" potentials of the average receiver. Fig. 1 shows the circuit

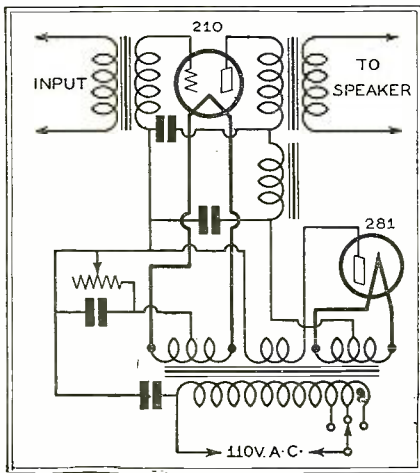

FIG. 1

diagram of a typical power amplifier. The changeover, so as to dispense with "B" batteries, is extremely simple and very little extra equipment is required. Fig. 2 shows the added voltage reducers

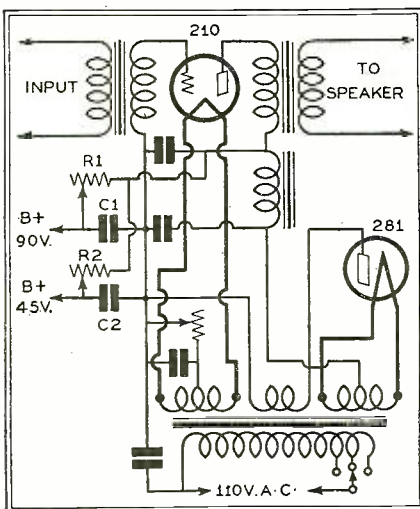

FIG. 2

READERS will notice that the former "I Want To Know" department of RADIO NEWS is no longer contained in its pages in that form. Instead, the problems which come to this department in the form of questions will be dealt with in this, the Experimenter section, and the information presented here will be of a more detailed nature. No longer will we merely present a questioner's problem and its abbreviated answer.

However, your questions, at the regular established fee of twenty-five cents per question, will be answered by a personal reply. Continue to send such questions to the "I Want to Know" department.

—THE EDITORS.

R1 and R2. These variable resistors may be of the compression type, and have a range of 0 to 100,000 ohms. The cases of the resistors should by all means be connected to the low or reduced potential side. C1 and C2 are on the order of 1 mfd. 250 volt d.c. filter condensers. With this arrangement as shown in Fig. 2 a wide variation of plate voltages can be obtained; a third voltage reducer may also be incorporated if, say, 45, 90 and 135 volts are required. While "C" battery voltages may also be obtained, it is not advised, as radical changes to the unit will be necessary. Dry "C" batteries with this unit are by far the more convenient and need only to be replaced at the end of, say, nine months' use.

Screen-Grid Audio Amplification

Although the remarkable potentialities of the screen-grid tube are generally recognized today and are being exploited more and more, the idea is generally prevalent that this tube is uniquely a radio-frequency amplifier and therefore unsuited to any other function. This is certainly not the case. As a space-charge audio amplifier, the screen-grid tube provides excellent volume per stage.

In employing the screen-grid tube as an audio amplifier, special transformers, designed particularly for this purpose, may be employed. However, a straight resistance-coupled amplifier is preferable for many reasons, and is certainly the least expensive. The unusual characteristics of a very high impedance plate load and a very low capacity feedback of the screen-grid tube combine in producing a tonal quality of the first order.

Due to the enormous amplification factor of the screen-grid tube, it is advisable to employ only one stage of this kind, and to place the same immediately following the detector, in order that the power output of the tube may not be exceeded. The diagram Fig. 3, suggested by the engineering staff of the International Resistance Company, shows a good circuit, and is offered merely as a suggestion, since the radio experimenter may work out his own version of a screen-grid audio amplifier. It will be noted that the detector tube works into a resistive load of 50,000 ohms, R5. R2 is a 25-ohm resistor that provides the necessary 3.3 volts to the filament of the tube. R4 should have a resistance of 250,000 ohms, while R1 and R6 are grid leaks of 3 megohms each. R3 is a conventional rheostat of 6 ohms.

Due to the large amplification in a

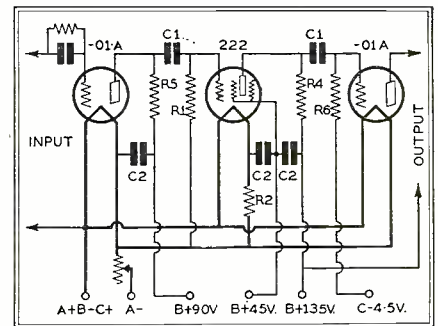
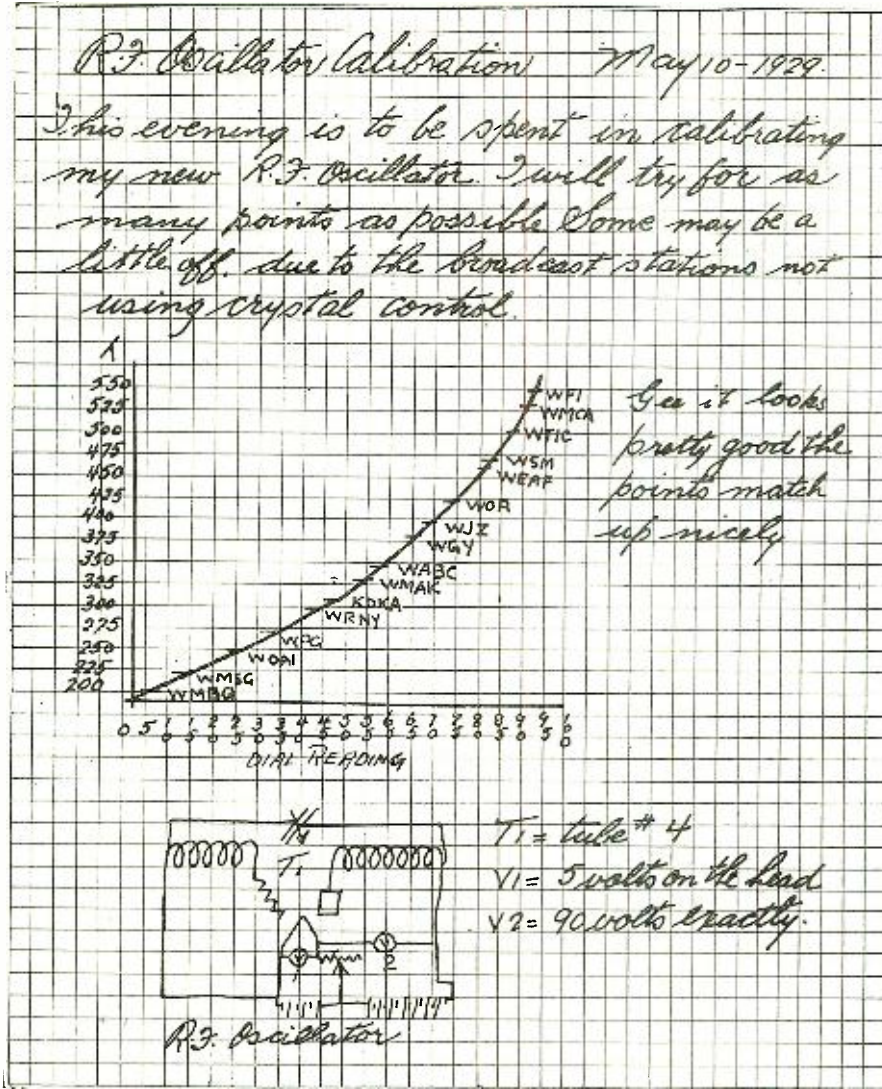

FIG. 3

screen-grid audio amplifier, the resistors must be selected with care. They must be accurate, in the first place, and certainly must not be subject to sudden resistance changes or fluctuations. Resistors must be moisture-proof. The metallized type fulfill these various requirements and for this reason are being widely applied to experimental and commercial screen-grid circuits.



repeated with a brother experimenter. This is a decided advantage, as here lies the opportunity for comparison and the formation of ideas for new experiments. Naturally, each experimenter cannot try everything for himself. One's time and money are limited; besides, some experiments are best left to the better equipped radio laboratories.

Radio patents have been lost to the rightful owner because of the inability of the experimenter to prove by written record his right to the invention. Keep a data book, not necessarily the loose-leaf kind; write in ink, making a detailed note of every experiment with its date. The Experimenters' column belongs to the experimenter, and is for the purpose of going over, together, various kinks, ideas and their solution. If you have any questions or suggestions, let's have them.

Set Tester

With the universal use of gang condensers comes the need for an easy method for balancing. Being able to tune in a few high-powered broadcast transmitters helps materially in such work, but the majority of experimenters are not so fortunate as to have this class of station on a number of wavelengths in the immediate community. So the need arises for some simple piece of apparatus that will produce a strong carrier wave on any desired wavelength. The apparatus required for the set tester may be found in all experimenters' junk boxes. Now, referring to Fig. 4, we will run through the parts. The most important piece of apparatus is the condenser C1, of a capacity of .00035 mfd. This condenser should be well constructed, as the plate potential is across it and a breakdown or shorted plate will ruin the "B" battery. The inductances L1 and L2 are wound on a 3-inch form with No. 22 d.c.c. wire. L1 consists of 32 turns, while 34 turns are wound on L2. Both these wirings should be in the same direction. The audio choke, L3, may, on account of the small plate current, be the secondary of an audio transformer. No matter if the primary is burnt out, so much the better, as we will not be tempted to remove it for some other experiment. The two tubes are of the 199 variety, with 30 ohms each in R1 and R2. Either a modulation transformer or a good low-ratio audio transformer is needed for T1. The phonograph pick-up, PP, is used to obtain a source of tone in the shape of phonograph reproduction to modulate our test

FIG. 4

A TYPICAL PAGE FROM AN EXPERIMENTER'S NOTEBOOK. STYLE MATTERS LITTLE, BUT PROPERLY RECORDED DATA ARE VALUABLE

To the Experimenter

THE experimenter who uses pencil and paper before, during and after each test, has conducted an experiment well worth while. Before tackling any problem, it should be outlined on paper. The outline should consist of the problem, the practical solution, all possible angles as well as the manner of procedure. Analysis of the problem is simply dividing it into small sections so as to give a clear insight and in this way various minor details will readily group themselves into a completed problem. As a rule, the experimenter spends too little time with his records. The final answer is really of no value if all is forgotten of the difficulties and their solutions. It is only by comparison of a number of measurements on one subject that the experimenter may attempt to predict or even form a definite conclusion on that subject.

In a radio engineering laboratory, very careful notes are kept of each day's work. These records include diagrams of the problem, before and during each change; data on the reaction of each piece of apparatus as well as the list including each part in the layout. By this method, a duplicate of the experiment may be tried at any time with a definite result in view. Naturally, the experimenter has not the elaborate equipment of a radio laboratory, but with a calibrated oscil-

lator, a good voltmeter, a milliammeter and shunts, and a calibrated variable condenser, a long list of experiments may be undertaken.

When rearranging an experiment, change only one thing at a time, making careful note of the change in wiring or apparatus, as well as the result. It is also advisable after each experiment is complete, to write a summary, and in doing this no emphasis strong enough can be made as to the importance of noting even the smallest detail. With the complete record, the experiment can be intelligently

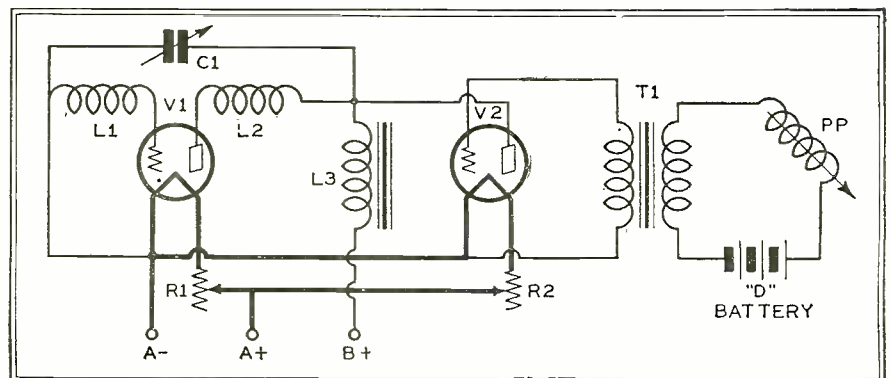

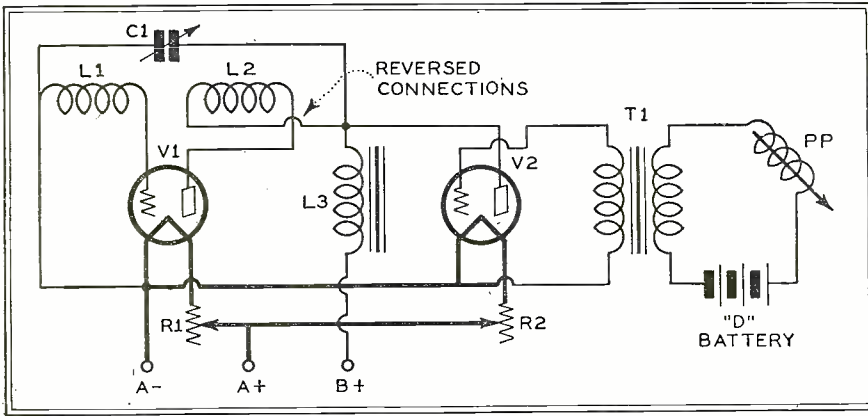

FIG. 5

oscillator. Battery D will have to be experimented with, as its correct value will depend on the type of pick-up used at PP. Three dry cells will do nicely for the "A" battery, and from 60 to 90 volts for the "B" is plenty. Now that we have the set tester built and all ready for operation, let us make sure that V1 does actually oscillate. Tune a broadcast receiver on any station near the middle of the dial. Light up V1 and V2 and tune C1 slowly from its minimum to its maximum setting. As the tester passes through

and wavelength. Usually this is possible by listening for the station's call letters; by referring to a newspaper or current call book, for the wavelength, the frequency equivalent may be obtained. Now, without moving the dial of the detector tuning condenser, rotate the dial of the oscillator. As resonance is approached a high-pitched squeal (referred to above) will start gradually coming to a beat note and then back to the high pitch. The beat note or the point midway between

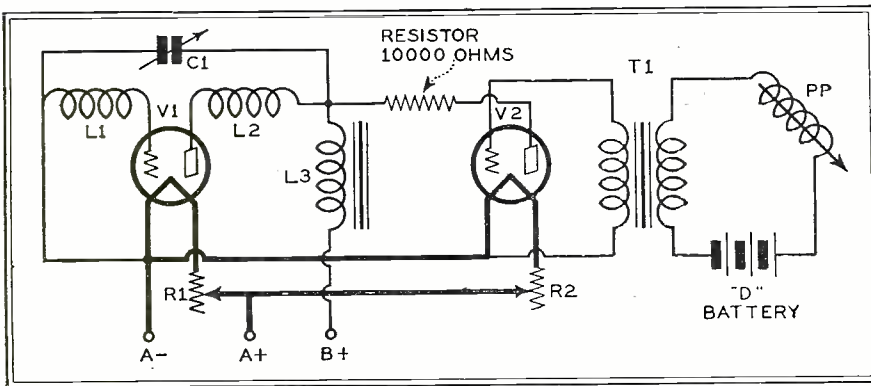

FIG. 6

the frequency band that the receiver is operating on, a loud squeal will result, providing V1 is oscillating. Imagine that the squeal has not developed; all right, that is simple; reverse the winding leads on L2 as shown in Fig. 5. This time the squeal will be heard.

So now the tester is ready for calibration. Mr. Brennan has explained thoroughly how this is accomplished in his construction article of the modulated oscillator. For those who have not the February issue of RADIO NEWS, we will repeat what he said on this subject. "Calibration of an oscillator is not as difficult as it sounds. The procedure to be followed for the broadcast band of frequencies will be explained. A simple one-tube regenerative detector is all the accessory needed. Insert the broadcast coil in its mounting, place the 'tester' near the regenerative detector and then turn on both the detector and the 'tester.' Begin at the high end of the dial. When a station is tuned in, determine its identity

the two high-pitched squeals is the point to be noted and this is the wavelength, on our 'tester,' that the broadcast station is using. Mark down the dial reading of the 'tester' tuning condenser carefully, continuing the calibrations on as many broadcast stations as possible. Having a number of wavelengths for our tester, it is now ready for the pick-up, PP, to be used. This pick-up may ordinarily be of the phonograph type. Adjust the tuning condenser C1 to a wavelength on which there is no broadcast operating, set the phonograph going and enjoy the thrill. The plate voltage of the tube V2 may be too high, which will result in distorted transmission. This can be rectified by inserting a 10,000-ohm grid resistor as shown in Fig. 6. A unit of this type will prove its worth for neutralizing receivers, testing sets for over-all amplification at the high, medium and low wavelengths. As experience is gained with the operation of the set tester, various tests will suggest themselves to the experimenter."

Using Two Speakers

The experimenter who, for peace in the family, uses a commercial receiver with a built-in dynamic speaker may wish to equip this receiver with an additional speaker of the magnetic type. Having speakers at various locations throughout the home is by no means new. But a number of us have been a little timid at the idea of tinkering with the family receiver. In Fig. 7 is shown the average push-pull commercial hook-up. Here T2, the output transformer of the push-pull stage, is of the step-down variety. This transformer has in some cases a step-down of as much as 8 to 1. A ratio of this kind is, of course, necessary

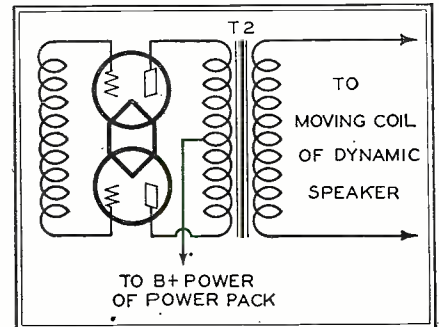

FIG. 7

for the dynamic speaker where large current changes, and not voltage changes, are required. With the magnetic speaker somewhat more different is the case; that is, voltage changes as well as current changes produce the greatest armature variations.

Fig. 8 shows the method employed in connecting the additional parts to the circuit. C1 and C2 are 2 mfd. 400-volt filter condensers. AC1 is an audio choke of 30 henries. C2 is connected in the

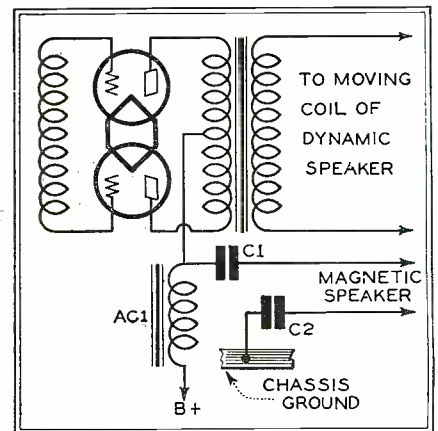

FIG. 8

grounded metal portion of the receiver chassis and gives added protection if, as in some receivers, the chassis ground is at a "C" potential instead of a "B-." A neat arrangement may be worked out to suit the experimenter's fancy by wiring outlets in the various rooms where "local speakers" are desired.

The Serviceman

A Ready Reference

Mr. M. C. Clopp of Haines, Oregon, suggests that experimenters and servicemen should, whenever possible, pass along ideas, as the experience of others is of value, not only to the beginner but to the old head as well. The contribution of Mr. Clopp follows; experimenters and servicemen should keep on hand a supply of information, and as radio magazines contain up-to-date developments and ideas, they should be saved for future use.

to find that this magazine would be the seventeenth from the bottom in the third pile. The reason for having the magazines numbered from the bottom to the top is for the convenience it offers, as late issues can be placed on the top of an incomplete pile.

A Short Cut

Mr. E. W. Bayer of Ensenada, Porto Rico, has the following suggestions to make to servicemen who find trouble in the audio channel of a radio receiver.

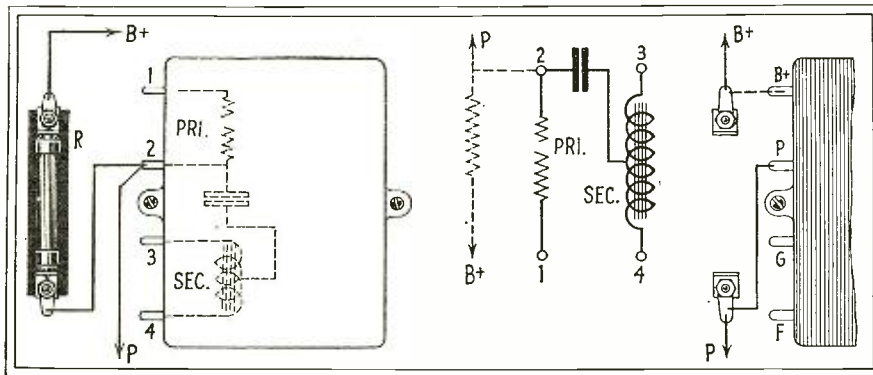

FIG. 1—A, B AND C, SHOWING OPEN-CIRCUITED PRIMARY, AND ITS REPAIR

Several years ago I began buying radio magazines and storing them away, but when I wanted to find information about a certain subject, it often required hours of search to find the article on the subject I wanted. A plan was hit upon that enabled me to get the needed information in double quick time. Get all your magazines together and print on the cover of each issue a number. Number the first magazine picked up No. 1, the second 2 and so on, so that later they can be piled in rotation. After all the magazines have been numbered, make an index book. This can be done by using a common note book. On the first page print the letter "A," leave five pages blank, and print the letter "B." Continue this process until the alphabet has been gone through.

Select from the magazines the articles that will be of use for future information. Arrange the captions of these articles in the index book, or in other words, under the letter "S" write all the captions of the articles dealing with speakers, shielding, etc., and opposite each title the magazine number as well as the page number the article appears.

The magazines are now piled on a shelf, putting twenty to a pile. The first pile should be placed at the left of the shelf, starting with magazine No. 1, ending the pile with No. 20. The second pile of course starts with No. 21 and ends with No. 40 and so on. Shelf room of course is the only limiting factor. Now imagine that an article on Condensers is required. We look up "C" in the index book and here we find "Condensers and their uses" appeared in magazine 57, page 726. As there are twenty magazines to a pile it does not require a slide rule

The accompanying sketch, shown in Fig. 1, will illustrate a method I have used extensively in putting into commission sets that have come in for repairs, and which upon test have been found to have a burned-out transformer primary or secondary.

It is only necessary to place a resistance mount in the set, near the transformer to be repaired, and remove the B connection from the transformer and secure it to one side of the resistor mounting. The other side of the resistor mounting is connected to "P" terminal of the transformer. If the transformer at fault is type SM-255, a 25,000 ohm resistance will be correct to insert in the resistor mounting. If it is a SM-256, then a 50,000 ohm resistance will be required. For other types of transformers, a 100,000 ohm resistance should be employed.

In this climate, transformers are exceptionally susceptible to opening in the primary circuit, and so to avoid trouble in making repairs, I equip all sets going out with SM transformers of these two types, and also wire in the resistor mount when the set is wired. Then if the set comes in with a primary of a transformer open, I need only to clip the wire between "P" and "2" as per B in Fig. 1, and insert the proper resistor in the mounting, thus the labor and expense necessary to replace the entire transformer is entirely avoided.

Test Equipment for the Serviceman

From Mr. Gordon E. Lockerd, of Portales, New Mexico, come the following comments and advice to servicemen.

"I am glad to see that you are devoting a department to radio servicemen. I have been in the radio service business since 1922 and have received many of my ideas from your magazine; in fact my entire radio education.

"I reside in a part of the country which is about as far from good broadcasting stations as any other section of the country. Although night time reception is good in nearly all standard receivers, there are very few that we can depend on for consistent daylight reception, and these must be in the pink of condition. This keeps the serviceman guessing at times to keep up these sets to their maximum efficiency, which is required at all times for daylight reception.

"My simple and inexpensive equipment and methods of service might be of some interest to other servicemen.

"Aside from the various radio wrenches, pliers, soldering irons, solder, nut and solder lug assortments, etc., which every radio man should possess, my most prized and most used piece of apparatus is merely a two-range voltmeter, 0-7 and 0-200 volt scales. This instrument I use to check the plate and filament voltages

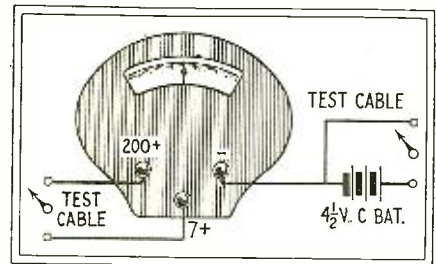

FIG. 2—A

as well as a continuity tester for all circuits in the set, such as primaries and secondaries of all radio and audio frequency transformers and for faulty wiring. This instrument is arranged somewhat as the sketch shown in Fig. 2. I

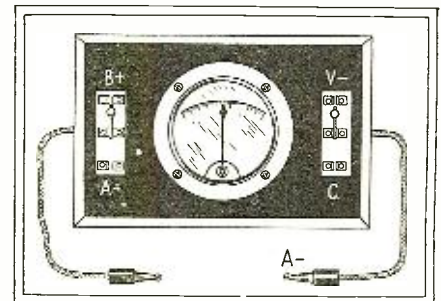

FIG. 2—B

believe it is about as handy an arrangement as can be devised, and can be used to locate at least ninety per cent of all troubles in d.c. receivers.

"In addition to this tester, a tube rejuvenator and d.c. light socket tube tester. I have in my equipment one of the more modern tube and set testers which I use for testing the new sets and tubes."

Trouble-Shooting

In the prevention and cure of receiver troubles, the following notes prepared by Mr. Clarence W. Wright, of Nashville, Tenn., will be of aid to many servicemen. Among other things Mr. Wright says:

I am a radio serviceman. I want to thank you for the service information in the April issue of RADIO NEWS. I think this is one of the best things you have had for some time.

Below are some service notes that I think will be of some value to service men.

(1) To prevent audio oscillation (or whistle) in a set:

After replacing an audio transformer in a set, I have had trouble with the set whistling and thus causing distortion. This trouble can usually be cleared up by reversing the secondary leads on one of the audio transformers.

(2) Noisy volume controls on sets:

Noisy volume controls on sets can be made to operate smoothly and quietly by first cleaning the slider contact and the resistance unit with alcohol; then bend the slider so as to make a firm contact; next oil the unit with nujol.

(3) Loud audio howl in push-pull amplifier sets when first turned on:

I have had several new sets that would start howling when first turned on, but after the tubes heated up the set would operate satisfactorily. After experimenting and working with the set for quite a while, I found that the set would work fine by changing around the 226

tube in the first stage audio until one was found that did not produce the howl.

The Serviceman's Kit

"What should a radio serviceman carry in his repair kit? I shall try to make a few suggestions by describing my own kit and what it contains." So says Mr. C. J. Anderson of Burlington, Kans.

I carry everything in a small case fourteen inches long, nine and one-half inches high, and five inches deep. I put small articles such as spaghetti, hook-up wire and grid leaks and small condensers in the pocket in the lid. I also find room there for a pair of headphones with a folding headband and a Weston plug.

Two meters are carried, one pocket wet-battery tester and a combination 0-50 voltammeter. These are carried in a small cardboard box. Besides these, I carry a small two-cell flat type flashlight battery with a Fahnestock clip soldered to the small terminal to which I can attach one side of the headset. I use the battery and headset in testing transformers, condensers, grid resistors, etc.

Spare parts consist of one good AF transformer, one cheaper replacement transformer, one UX socket, a rheostat for replacement in five-tube r.f. receivers, one 1 mfd. by-pass condenser, several smaller sizes condensers, a couple grid leaks, 2 and 3 megohms, a battery switch, one lightning arrester, a 4½ volt "C" battery, one 201A tube and one 199 tube. I carry them all in their original cartons.

For tools, two pairs pliers, one with square nose fairly heavy and one slim-nosed pair that has rounded sides which do not pinch fingers. Three screw drivers, one small and rather long to remove dials, one short and heavier and another long slim one to remove the chassis of Atwater Kents No. 35. Then I have a small alcohol torch with a home-made device on top to hold a small soldering iron. A packet of safety paper matches is handy to light the torch. A punch drill, small tin-snips, a few odd screws and nuts, a length of spaghetti, a roll of hook-up wire, a length of rosin core solder and a small roll of tape complete my kit. Much of this can be supplied very well from the dime store.

This may seem quite a lot to carry in so small a case, but careful arrangement of parts leaves plenty of room. I also found room for a small home-made set tester, but I find that two pocket meters and headset and battery are all that are really necessary, although additional equipment is sometimes convenient. A lightning arrester is included because this necessary little device is often omitted when a set is installed. A "C" battery is included because it is often the panacea for quieting a howling receiver and is also often installed in sets not made for a "C" battery, thus improving tone and lengthening the life of the "B" battery.

In actual practice, I have found this kit to contain practically everything necessary to repair a battery-operated receiver on the spot.

(Continued on page 180)

On Short Waves

IN the construction of modern short-wave receivers, the builder strives toward two objectives. Namely, selectivity and adequate sound volume. Selectivity is nothing more than being able to choose one station, without interference. Transmitters on adjacent frequency bands must be entirely eliminated. Adequate sound volume should be such that no matter how weak the signal, it can be raised to a desired volume. So with these two prime requisites in mind, now would be a good time to briefly review the short-wave receiver of the past few years. Yesterday's receiver consisted of a regenerative detector and one or two stages of audio amplification. Little thought was given to how this receiver should differ from the broadcast receiver of eight or nine years ago, other than the use of smaller tuning coils and condensers. Just as the frequency separation has narrowed down on the broadcast band, so is the same rapidly taking place in our short-wave band.

The discussion that follows and for which we are indebted to Mr. J. E. Smith of the National Radio Institute, Washington, D. C., is not an attempt to hurry one into the building of this or that receiver, but rather, as an outline, to present the problems that underlie all short-wave receiver designs. The frequency band that our receiver is to cover is already decided for us, being from 10 to 200 meters, or in

kilocycles 1,500 to 30,000. Of course, there are a number of amateurs employing frequencies above 30,000 k.c., but this region above 30,000 k.c. has very interesting literature and some special problems of its own. This high frequency will not be considered in the following discussion, for we will find enough of interest in the 10 to 200 meter region.

In the normal broadcast tuner, we have tuning range of 200 to 550 meters, or 545 to 1500 k.c. When it is considered that the designer finds it somewhat troublesome to spread this frequency band of slightly under 1000 k.c. in a satisfactory manner over the dial, one begins to appreciate that it is no simple problem to take care of the immense band of 28,500 k.c. over which our short-wave receiver is to tune.

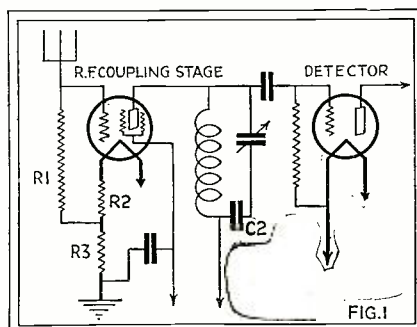

For the commercial amateur relay station the problem is usually rather simple. Signals are to be received from a limited number of stations working on wavelengths that can be predetermined. Thus it is possible to use a tuner with a narrow tuning range and therefore of quite normal design and construction as far as the tuned circuits go. The exact form the set takes depends entirely upon other conditions and accordingly message-handling receivers are usually built for the particular job; hence a general description is useless for our purpose. So, with the comment that the receivers for this work are usually of the best construction, fully shielded, and in many cases are provided with filter systems in the audio portion, we may therefore drop them from further discussion.

Just one more mention of the broadcast receiver; here, we find, rather good performance from all standpoints is obtained with the use of a tuning capacity of about .00035 or .0005 mfd. One accordingly is tempted to try to design the short-wave tuning by cutting down the inductance coil and condenser in the same ratio. If then we cut down a 200-550 meter tuner by removing 1/3 of the capacity as well as 1/3 of the inductance, the expected result should be 66 to 200 meters. Going further with the same process and removing the capacity and inductance to 1/10 of its original value,

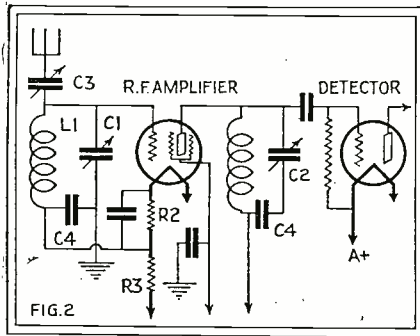

the tuner should have a tuner for the band 20 and 55 meters.

Unfortunately, this simple process does not work out. By reducing the capacity and inductance of the circuit to 1/3 of the original value, the tuner does not go down from 200 to 66 meters, but from 200 to about 90 meters. On thinking it over we can readily see that this is the result obtained, since the low end of the range is fixed by the lowest value of the tuning capacity and the associated apparatus connected with it that it can reach. Now it is very easy to remove 1/3 of the inductance and also it is easy to cut the top of the tuning capacity 1/3, but really

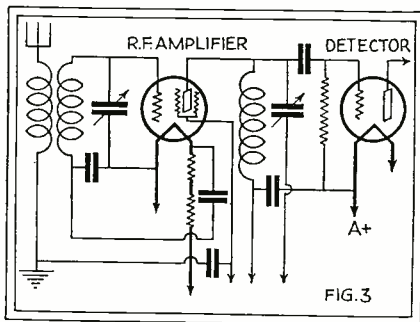

we have removed very little from the capacity condenser when it is at its minimum position. The ordinary tuning condenser has a so-called "zero capacity" of from 11 to 25 mmfd., while the associated wiring and tube will contribute another 20 mmfds. Thoughtful rearranging of the wiring may cut down this 20 mmfds. somewhat; redesign of the condenser will remove some of the "zero capacity," but will not in all probability attain the expected 66 to 200 meter band, much less 20 to 55 meters.

Thus in so simple a matter as the tuning circuits we run into a snag; it may be easily imagined other difficulties will stare us in the face before we are ready to place the short-wave receiver on the air. It will be found that all the queer things that happen in short-wave tuning circuits have sound explanations and seem irregular for the reason that they are new. Like all other things in physical science, queerness generally consists of not having all the facts or lack of understanding.

Selectivity Problems

Most short-wave receivers have exceedingly poor selectivity. The widespread impression that "short waves tune sharply" is without any basis in fact. Usually what is meant is that the receiver,

will tune a station in and out again with a very small movement of the dial. It is not realized that the design is such that meanwhile we have passed over a great many kilocycles, equivalent to a large portion of the dial on a receiver operating in the broadcast band. We would find that with two stations separated by 10 k.c. the tuning would be hopeless. Roughly, selectivity depends on the number of tuned circuits in the radio-frequency portion of the receiver. Since the majority of short-wave receivers employ only one tuned circuit, they have little selectivity, and this is painfully evident when one happens to be near a transmitter of any sort. As soon as short-wave high-powered transmitters multiply somewhat, multistage receivers will have to be operated. Because of the nuisance of making tuned stages run together as well as the troubles encountered in these several stages going into oscillation, we find that tuned radio frequency has not had the attention that it deserved. Thanks to the screen-grid tube, short-wave radio-frequency amplification is now coming in for its share of development, and the radio engineering laboratories are designing receivers employing "tuned impedance" as well as transformer coupling in the radio-frequency end.

In Fig. 1 is shown a circuit in its simplest form which makes use of the 222 type tube. Here the screen-grid tube acts as a coupling agent between the antenna and the detector circuit. The resistor R1, on the order of 10,000 ohms, is in series with the antenna and ground. A radio-frequency choke may be used in place of the resistor if desired. R2 and R3 are filament resistors of 15 ohms and 10 ohms respectively and drop the filament voltages to the required 3.3 volts as well as providing the necessary grid bias for the 222 tube. A coupling tube of this

type fully justifies its use and may be an added attraction to the already built short-wave receiver employing a regenerative detector and audio amplification. The choke is of the 85 millihenry type. C2, which is very necessary for the good of the "B" batteries and tubes, may be .005 mfd. Other values should be tried if "dead spots" appear in the tuning.

Fig. 2 illustrates the 222 tube in the rôle of a real radio-frequency amplifier. With this combination the tuning capacity C1 and the inductance L1 are approximately the same as C2 and L2. In Fig. 2, R2 and R3 are the same as in Fig. 1 and of course serve the same purpose. C3 serves the worthy purpose of tuning the antenna. The condensers C4 are in the order of .01 mfd. and to be satisfactory for isolation purposes should be of the type upon which moisture will have no effect. In Fig. 3 we have primarily the same circuit, with the exception that an antenna coil is employed instead of connecting the antenna through a small variable condenser to the grid of the tube. The use of this antenna coil will afford a greater degree of selectivity. Whether the circuits shown in Figs. 2 or 3 are used is, of course, entirely up to the builder himself (or herself).

Shielding

The use of shielding is becoming more common in short-wave tuners. In some cases it has been adopted as an advertising point and with no regard to the possible advantages which shielding has to offer. This has unfortunately resulted in a rather widespread suspicion of commercialism by prospective builders of any short-wave tuner having shielding. Such

THE NATIONAL SHORT-WAVE TUNER, WITHOUT AUDIO AMPLIFICATION

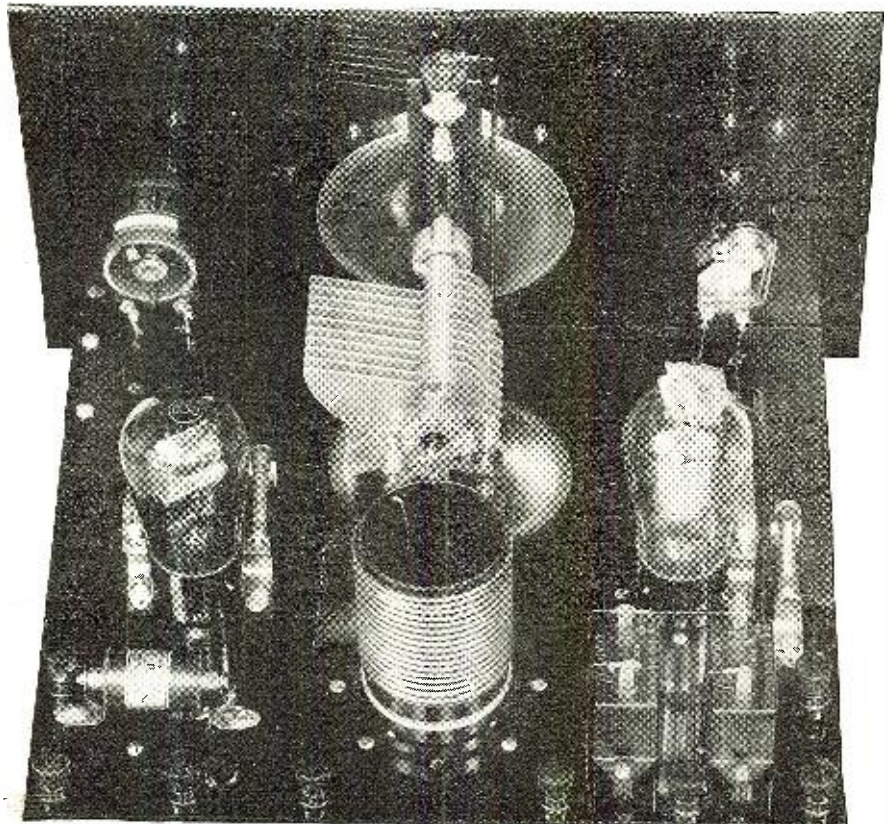

a suspicion is not justified. It is, of course, true that one does not improve a tuner by merely injudiciously armoring it; such a procedure is more than likely to detract from the set's performance. On the other hand, shielding does offer possible gains of a very definite sort, when sensibly used.

The use of shielding for purely shielding purposes should not be confused with the elimination of hand-capacity effects. A tuner with noticeable hand-capacity effects may be made workable simply by the use of a metal panel or metal backing placed behind the panel. The amplification will probably be reduced slightly and the tuning range altered a bit; but even at that it is an improvement, for one is now able to touch the controls without causing a change in tuning. However, in

tenings in the shape of screws or rivets. For copper the joints should, by all means, be soldered. Exceptions must of course be made, since wires are to enter and leave the shield, but the holes for these wires must be as small as possible. As to the lid, it must fit well, preferably flanged. Some thought will often show how all but two or three wires can be kept from entering the box. The ground connection for one can be made by simply using the shield for that purpose. Usually the "ground" also means the negative "A" and here, too, may save the drilling of a hole. Radio-frequency leads as they emerge from the shield naturally are to be regarded as exposed to trouble. Therefore, their line of travel to the next shielded point is to be made as short and as far from other radio-frequency wires

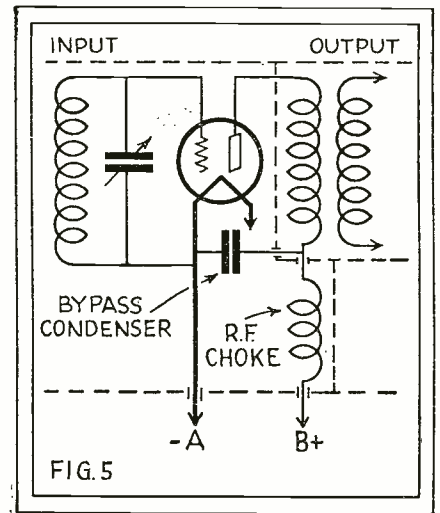

culty is caused by the battery leads than by those leads which we think of as carrying radio-frequency currents. The reason for this is that one is inclined to think of these leads as harmless, whereas they are the reverse. This may be explained as follows:

Suppose that we have a stage of screen-grid amplification with a tuned input and tuned output, as in Fig. 5. The output goes to the next tube and it does not matter what type of tube it is. Now if the tuned input (grid) circuit is not perfectly shielded from the tuned output (coupled to the plate) circuit we will have feedback between the two circuits with resulting oscillation, exactly as if the feedback had been through the tube. This is not wanted and therefore we shield the two tuned circuits from each other by putting them in separate shields. The tube will probably be placed in the can with the grid circuit, and the output circuit will be in the next can which may contain the next tube. Despite these precautions of shielding, this combination will certainly oscillate, unless the circuit

BELOW—A PILOT SHORT-WAVE SET, WITH TWO STAGES OF AUDIO AMPLIFICATION

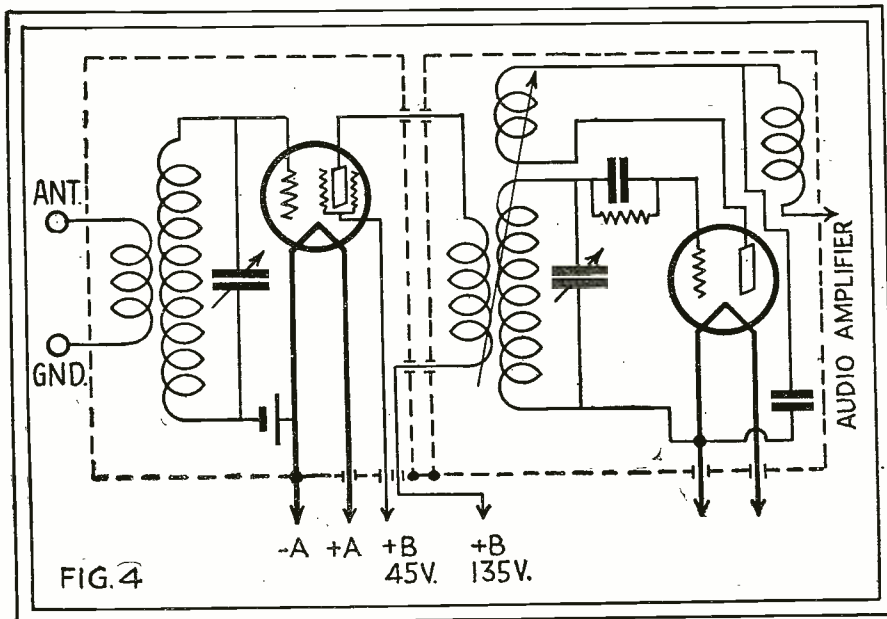

no way does this constitute satisfactory shielding of the tuned circuits. With radio-frequency circuits of either the long or short-wave type, the proper function of shielding is an entirely different one. The prime purpose is to provide completely enclosed metal cans or compartments in which the tuned circuits may be placed, secure from electromagnetic coupling to other adjacent circuits in the receiver. This result cannot be accomplished by a can of very thin sheet metal, since this will neither shield completely nor will its structural strength allow us to use a reasonably sized can. Shields placed near the tuning inductance will make a world of difference—for the worse, or, in other words, the can will alter the L/R ratio of the inductance. Copper and aluminum are the metals generally used for shields. The copper shield may be somewhat thinner than aluminum, due to its lower resistance, but should not be less than .030" or 30 mills.

Many shield builders have failed to appreciate that a solid sheet of metal stops being solid when a slot is made through it. This statement sounds silly, but was purposely made so as to emphasize the unreasonableness of making a copper or aluminum can with corners that let the daylight through. If aluminum is to be used, use 1/2" overlap with frequent fas-

as possible. If possible, place two successive shield sections next to each other so that the wire coming from one promptly enters the other shield. See Fig. 4.

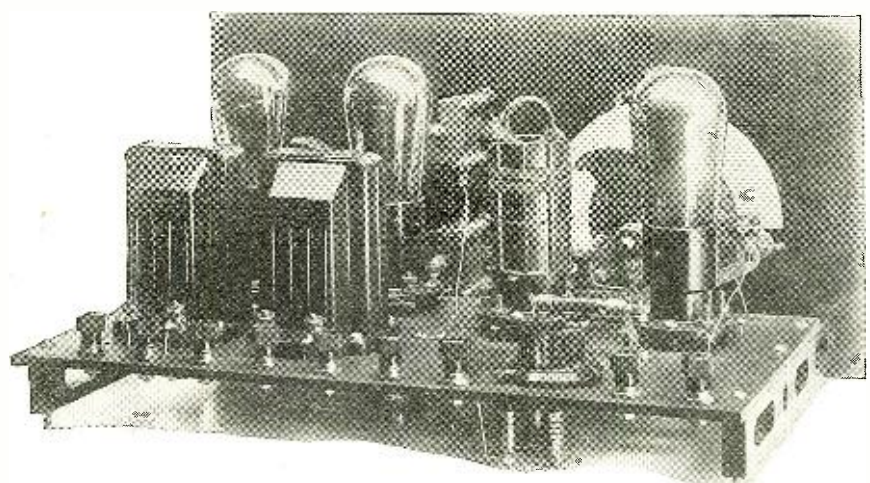

Methods of Filtering

The utmost care has to be exercised with the by-passing of radio-frequency currents in short-wave tuned radio-frequency systems. Probably more diffi-

cult is very inefficient. The reason is that the two tuned circuits are connected by wires which are common to and which lead to the same plate and filament batteries; it is through these leads the currents travel and by virtue of the common coupling

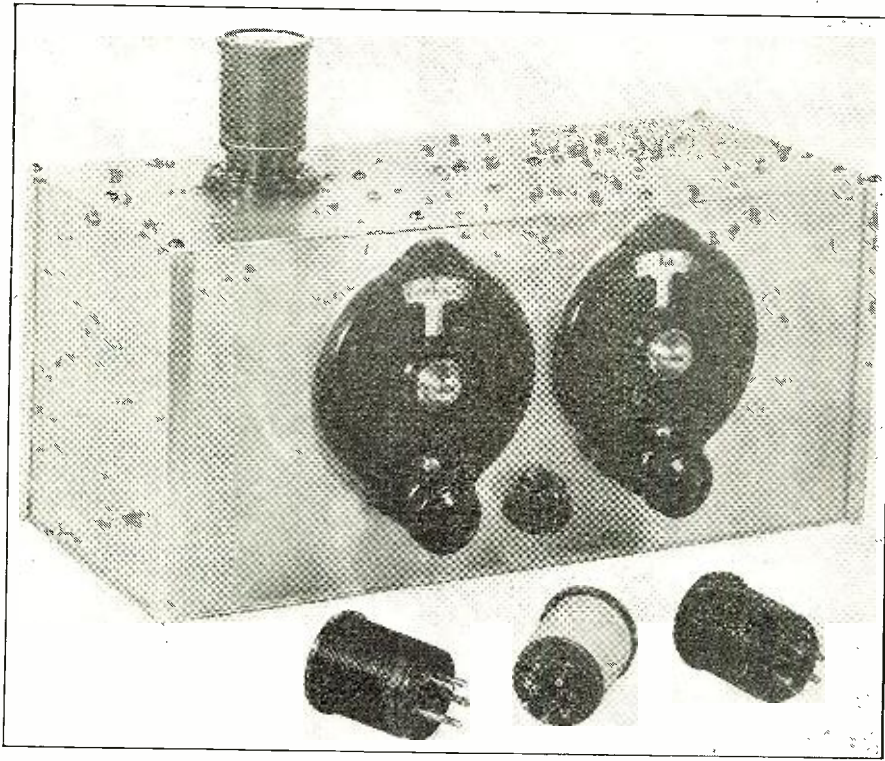

THE SILVER-MARSHALL ROUND-THE-WORLD FOUR S.-W. RECEIVER

an oscillatory condition is created. To eliminate this condition the currents must be prevented from leaving the shielded stages via the leads that supply the "C" bias, plate and filament voltage. This is accomplished by the use of by-pass condensers and radio-frequency chokes, as shown in Fig. 5. The condenser must be of ample capacity, low resistance and correct placement. For general use, a condenser of sufficient capacity is on the order of .1 mfd., although the use of larger capacities is sometimes found necessary. Low resistance refers to "loss" resistance rather than to leakage. It calls for a high grade of dielectric and to be sure on this point one must take the word of a reputable condenser manufacturer. The location of the by-pass condensers is even more important than the other requirements of the condensers. The usual practice of placing them in the base of the set is workable if each one is placed with its terminals right at the point of the coil where the leads (to be shunted) originate.

Where screen-grid tubes are used, it is not always necessary to have each tube in a separate can. In this respect, it is sufficient if the tuned circuits are shielded and the by-passing (and choking, if any) is skillfully employed.

Book Reviews

The Mathematics of Radio

WITHOUT question, John F. Rider has contributed to the radio art through his book, "The Mathematics of Radio" (Radio Treatise Co., Inc., New York, N. Y.), one of the most practical and pleasingly simple texts which we have yet encountered. It undoubtedly will be of inestimable aid to every class of radio man associated with the design, production, sales, service and repair of radio equipment.

Undoubtedly many fellows have, at some time or other, been obliged to refer for information on specific subject to one of the highly technical text-books on fundamental radio theory, only to be completely befuddled by the mass of intricate and complicated formulæ which deals in a general way with the problem in which he is concerned. Such texts unquestionably were intended for the class-room and for the highly trained engineer.

Mr. Rider's treatise is uncommonly refreshing in that it deals with every-day problems which confront those interested in the practical side of radio, in a simple, direct manner productive of immediate results.

Quoting from Mr. Rider's preface, "this treatise is not intended as a text-book of fundamental principles underlying radio. Being concerned with the problems of the practical man and the practical application of radio theory, we

have selected the subjects and treated them in such a manner that they cover the field of interest to the practical man, the radio service man, the professional set-builder, the experimenter and the receiver owner who has the desire to delve into the innards of his radio receiver."

That this field has been amply covered by the treatise in question can only be attested by a first-hand perusal of the book. It is replete with circuit diagrams, informative tables, and simple explanation of mathematical formulæ.

Space permits of listing only a few of the rather complete compilation of items treated, such as: Ohm's Law; Calculation of Resistances; Calculation of Capacity and Inductance; Design of Transformers and Chokes; Utility of Curves and Types of Curves; Multiple Stage Amplifiers; Alternating Current Tubes; Tube Structure; A and B Eliminators. In view of the value of the information it contains, this book is quite reasonably priced at \$2.00 per copy.

* * * *

"Radio Operating—Questions and Answers"

For ship radio operators or those who intend to become such operators, or for those concerned with the operation and functioning of any and all types of commercial transmitter and receiver equip-

ment, Messrs. Arthur R. Nilson and J. L. Hornung have prepared a revised, up-to-date edition of their former book, "Radio Operating—Questions and Answers" (McGraw-Hill Book Company, New York, N. Y.)

The new edition, intended as a companion volume to their text, "Practical Radio Telegraphy," is one that will undoubtedly find much favor with students desiring to become proficient in the radio communication art.

Every conceivable form of question which might suggest itself to the embryo operator is covered quite completely in this new edition. Besides dealing with such subjects as ship and shore equipment, it also treats with such items as the new Radio Laws and Traffic Regulations; The Radio Compass; Broadcasting Transmitters; Amateur Station Operation. In general, every phase of the communication art as related to radio is completely covered by a series of questions and answers so that those contemplating going before the Federal Radio Supervisors for the examination which may (or may not) result in their obtaining the coveted license, may be fore-armed with the correct type of information.

The book contains, beside the questions and answers, worthwhile data in the form of commercial types of transmitters and receivers; photographs of actual equipment and constructional drawings. This book is priced at \$2.00 per copy.

The Trade

Seen at the R. M. A.

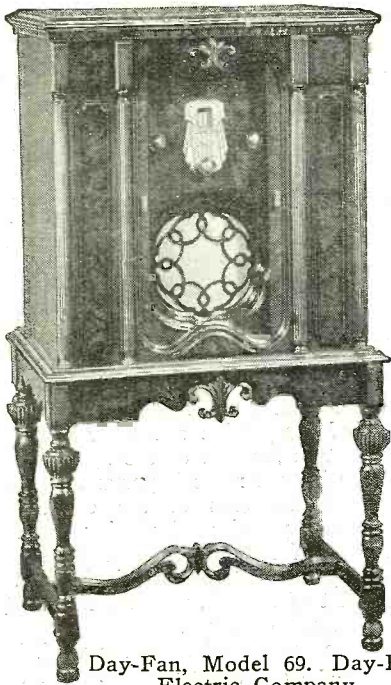

Day-Fan, Model 69. Day-Fan Electric Company

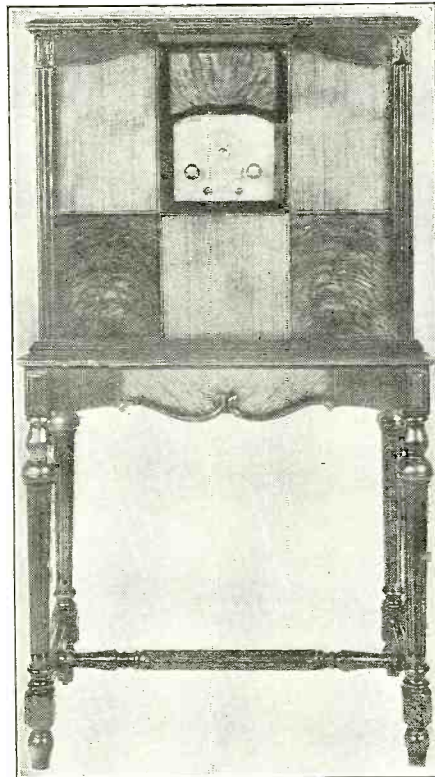

Colonial, Model 32. Colonial Radio Corporation



Victor, Model R-32. Victor Talking Machine Company



Caswell Powertone Pickup. Caswell Mfg. Company

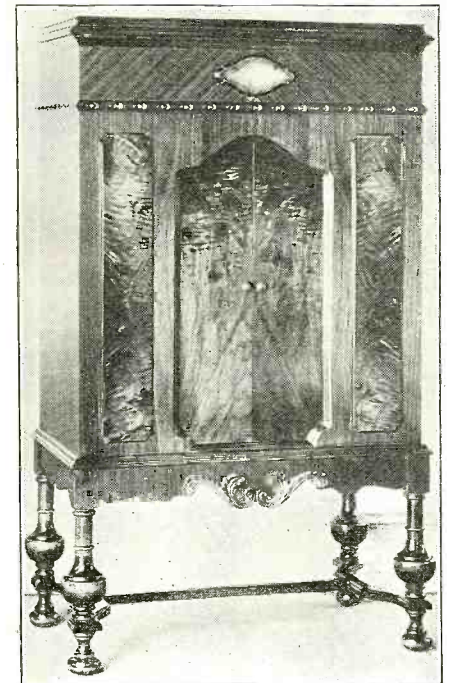

Edison Combination, Model C-4. Thos. A. Edison, Inc.

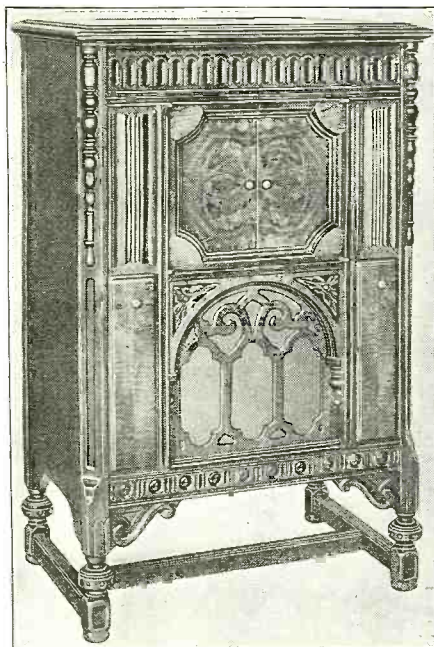

Temple Combination, Model 8-90. Temple Corporation

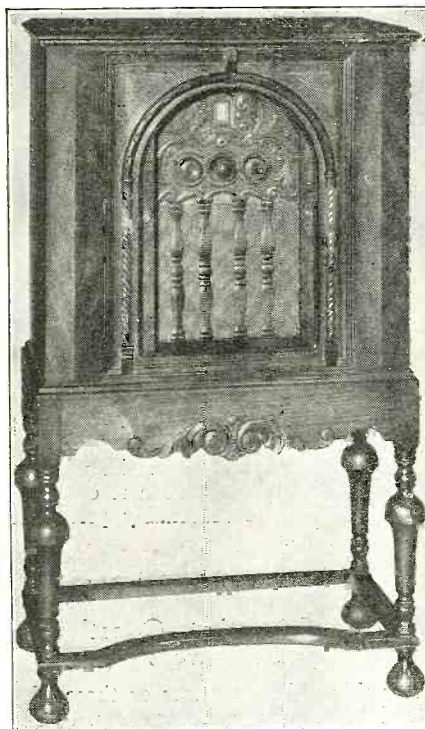

Eveready Console, Model No. 34. National Carbon Company



Utah Dynola a.c. Dynamic Speaker. Utah Radio Products Company

Broadcasts: *Chicago Show*

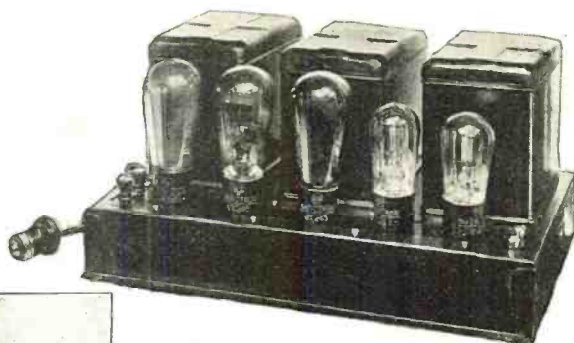

Powerizer, Push-Pull-45 Type.
Radio Receptor Company

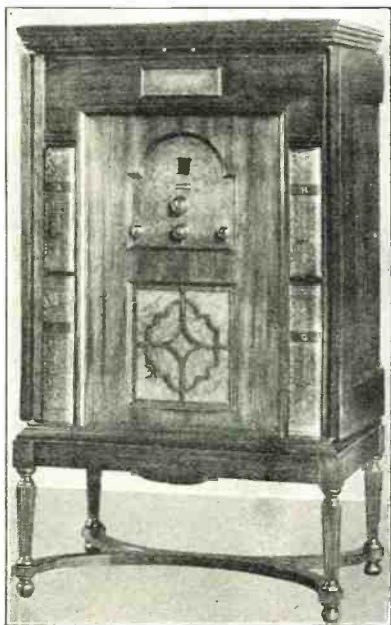

Edison Combination, Model C-2.
Thos. A. Edison, Inc.

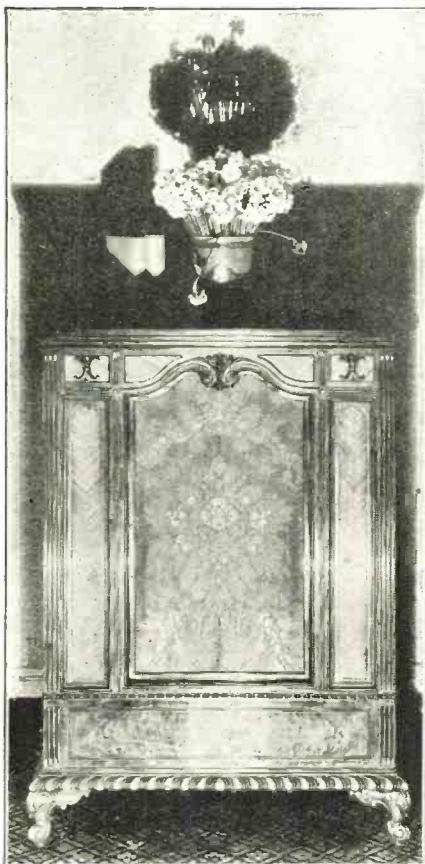

Kolster, Model K-45. Kolster
Radio Corporation

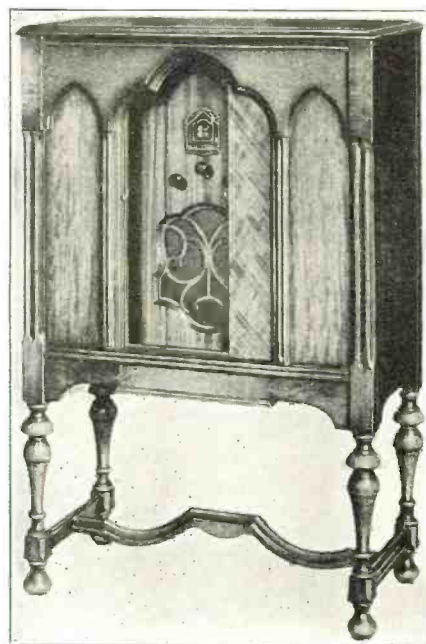

Kellogg, Model 523. Kellogg
Switchboard & Supply Company

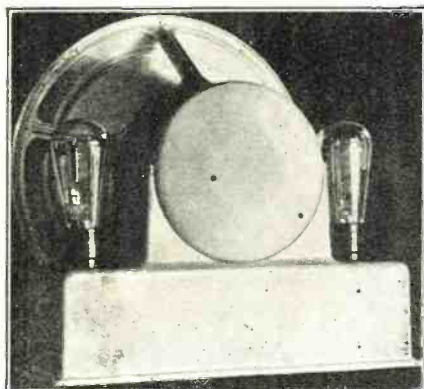

Best Theatre Dynamic Speaker.
Best Manufacturing Company



Fada Combination, Model 77.
F. A. D. Andrea, Inc.

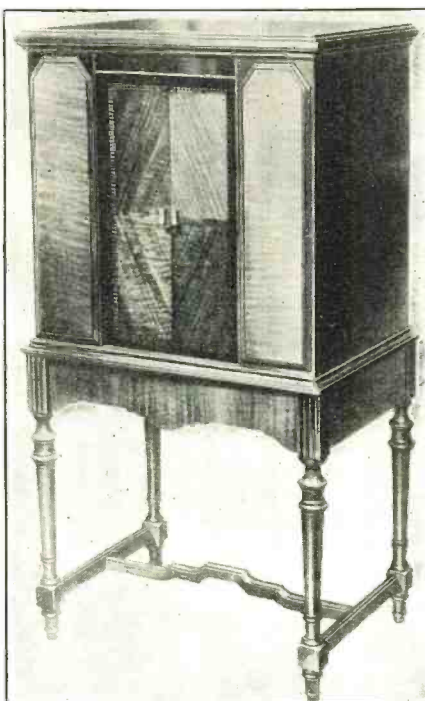

Amrad Serenata. The Amrad
Corporation

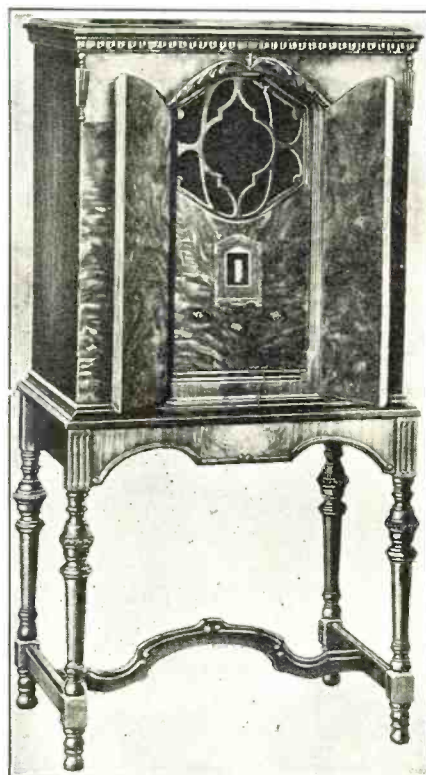

Bremer-Tulley, Model 82. Bremer-
Tulley Manufacturing Company

Seen at the Manufacturers'



Radio Master Cabinet, Model 158.
Radio Master Corporation

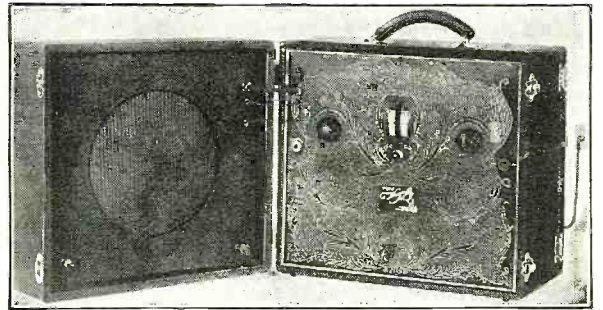

At the right—
Tom Thumb Por-
table. Automatic
Radio Mfg. Co.

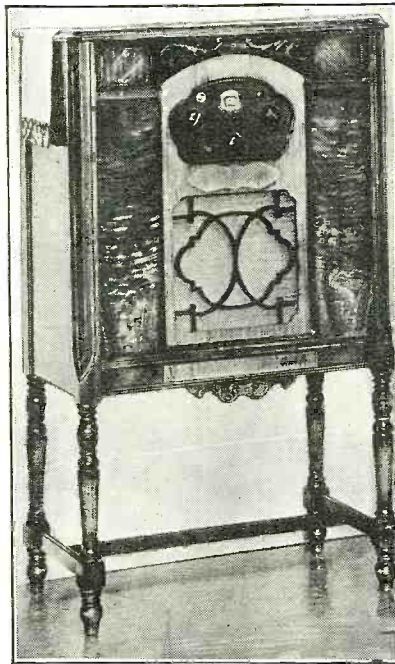

Pooley Cabinet, Model 8500. The
Pooley Company

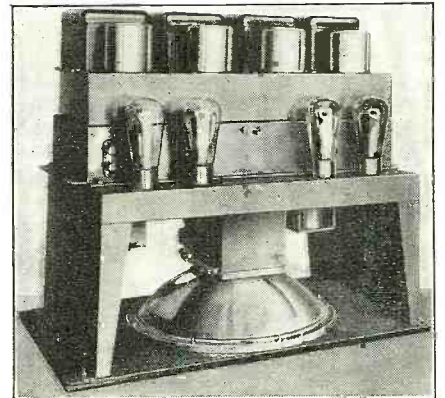

Colonial Model 32 Chassis. Colo-
nial Radio Corporation



Peerless Dynamic Speaker, Model
19-A. United Reproducers Cor-
poration

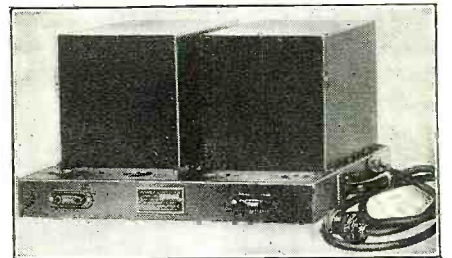

Power Amplifier, Model GA-15.
General Amplifier Company



Aston Cabinet, Model 206. Aston
Cabinet Manufacturers

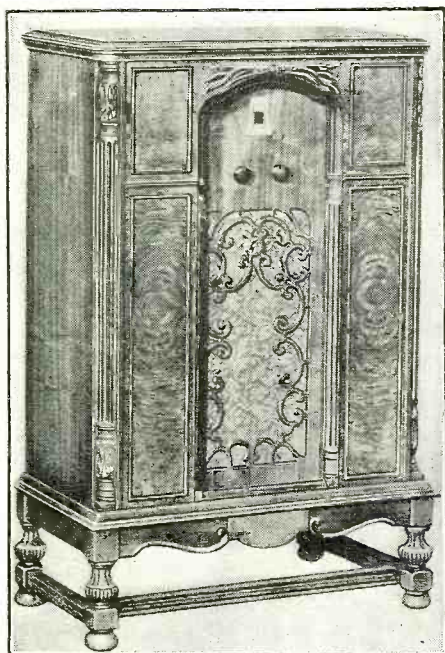

Peerless, Model No. 23. United
Reproducers Corporation

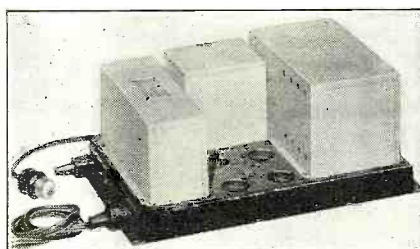

Operadio Power Amplifier. Oper-
adio Manufacturing Company

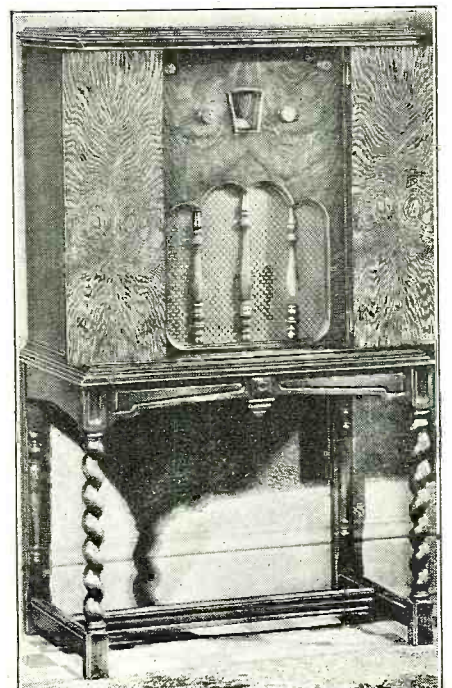

Star-Raider, Model R-20. Conti-
nental Radio Corporation

Show in Chicago

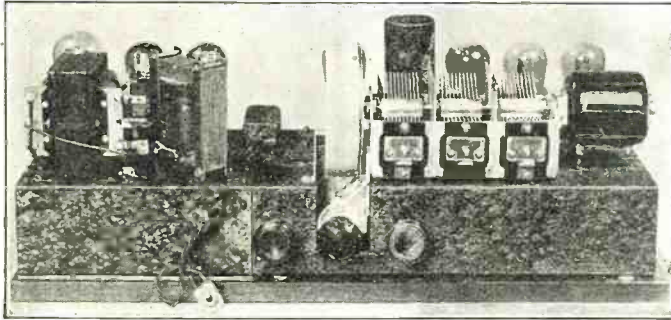

(Left)—Eveready Chassis, Series 30. National Carbon Company

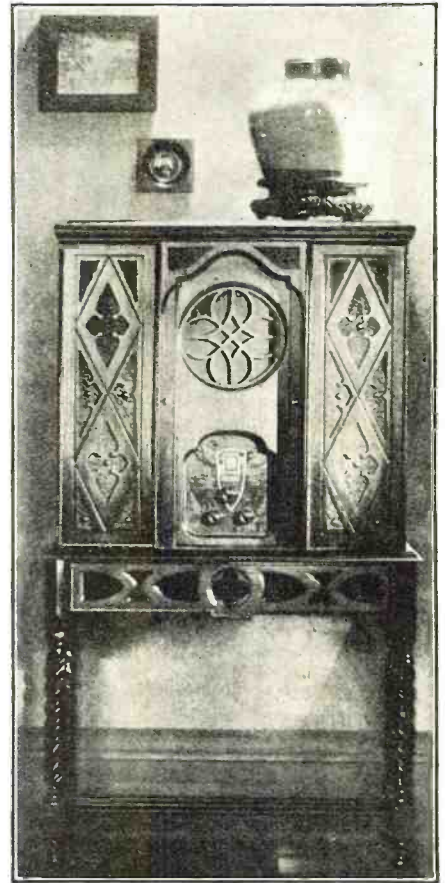

(Right)—Bosch De Luxe High-boy, American Bosch Magneto Corporation

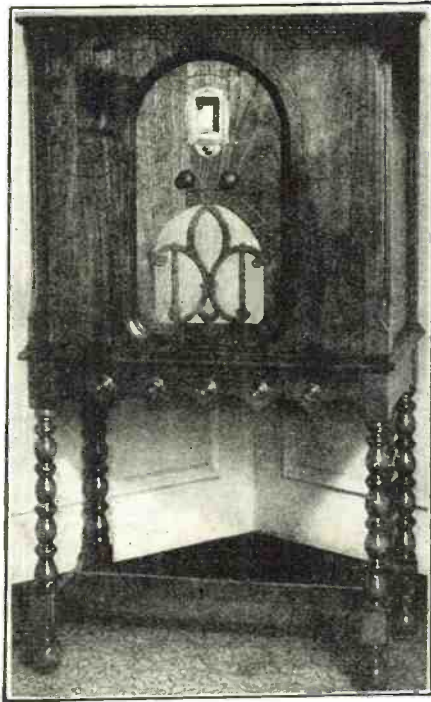

Steinite, Model No. 40. Steinite Radio Company



Temple Dynamic Speaker, Model 2. Temple Corporation



Rola Dynamic Speaker Chassis J-90. The Rola Company

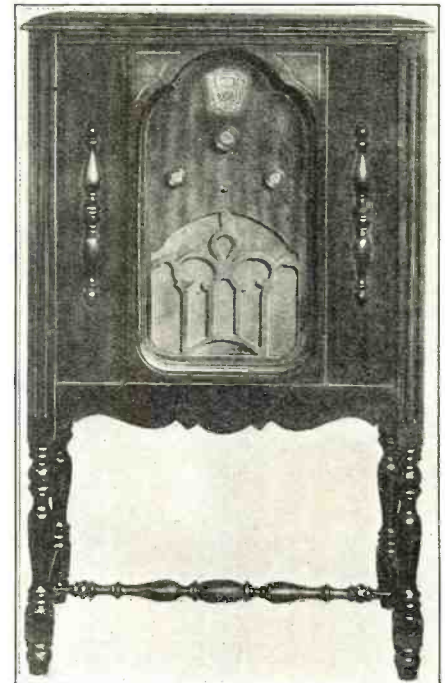

Freed Radio. Freed-Eisemann Radio Corporation



Zenith Combination Model 37-A. Zenith Radio Corporation



Baird Short-Wave Adapter. Short-wave & Television Laboratories, Inc.

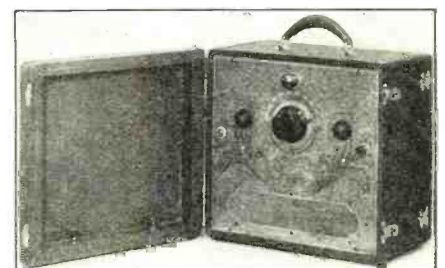

Baird Portaradio. Shortwave & Television Laboratories, Inc.

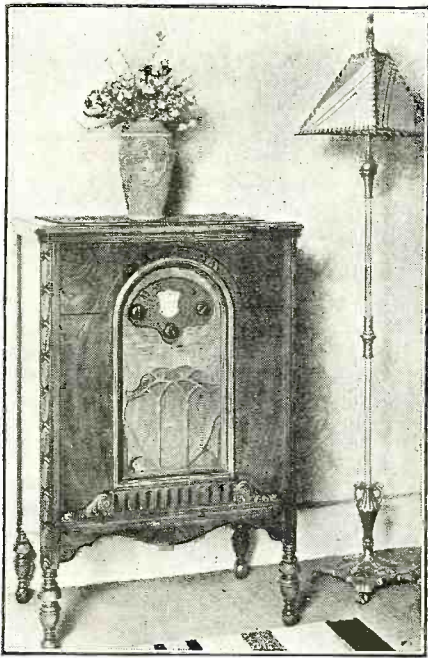

Red Lion Cabinet, Model 55-C.
Red Lion Cabinet Company

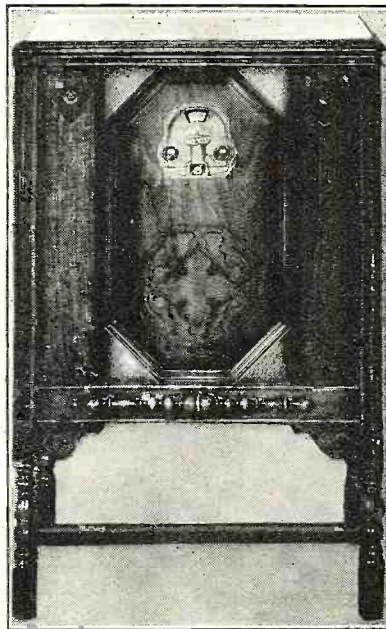

Kennedy Radio Console. Colin B.
Kennedy, Inc.

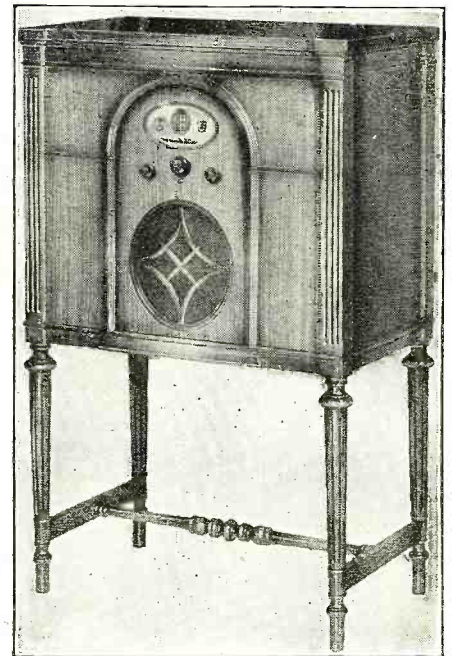

Silver Radio Lowboy. Silver-
Marshall, Inc.

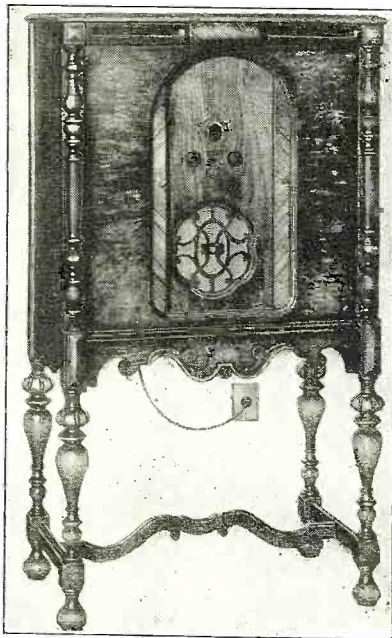

Radiotrope Neutrodyne, Model B.
U. S. Radio & Television Corp.

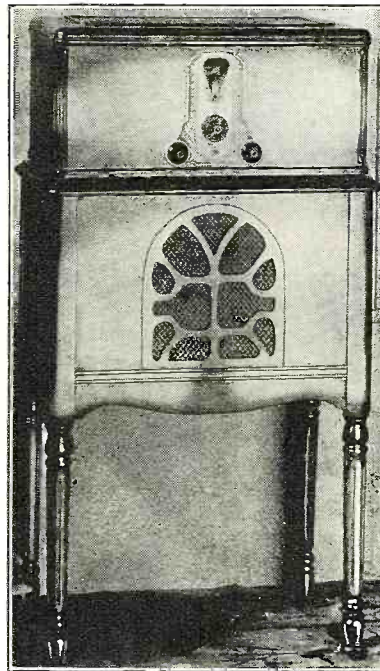

Stewart-Warner Consolette. The
Stewart-Warner Corporation

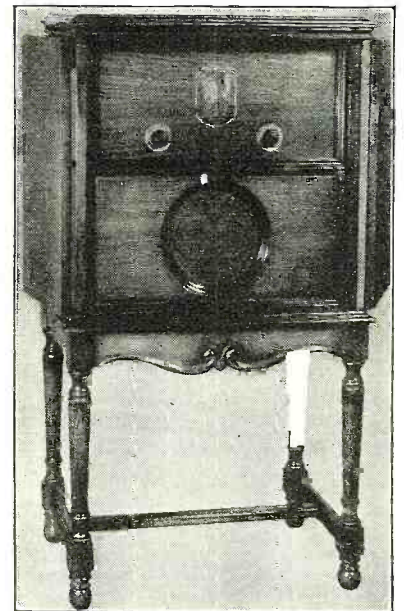

Emerson, Model C. Emerson
Radio Company

New Equipment and Manufacturing Trends

Radiall's Amperite Lin-A-trol

The experience in operating radio receivers from the line circuits during the past year has clearly demonstrated the need for line voltage regulation. Alternating current tubes are so designed that a variation of 10% will have practically no effect upon its operation or life. In other words, it is really of no advantage to regulate the voltage to less than 10% or plus or minus 5% since such variation has no effect, but greater variations materially affect both the operation of the set and life of the tubes. The "B" and "C" voltage should also be kept

Fig. 1

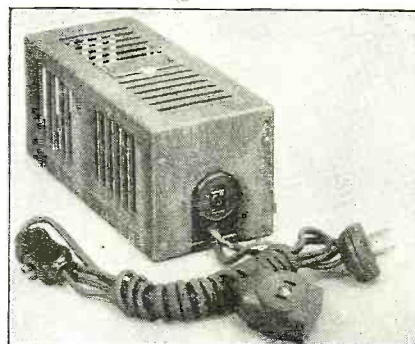

to a variation not greater than 10%. The voltages of power lines, however, vary from 95 to 125 volts. This is a variation of approximately 30%, and sometimes slightly greater variations are experienced. Such variations in voltage are usually due to the change in load on the power house or circuits feeding the house in which the receiver is being operated. The use of a flatiron or toaster will sometimes drop the voltage in a particular circuit 10 volts. A variation of 95 to 125 volts is much too great for the healthy operation of any receiver. The requirements of an efficient regulator for receivers are: 1—It must keep

the voltage on the receiver to within 10% or plus or minus 5%. 2—It must not consume too much power. 3—It is desirable that it be as compact as possible.

The Amperite voltage regulator (manufactured by Radiall Company, New York, N. Y.) operates on the thermo-electric principle. That is, its resistance varies very rapidly with small variations from any pre-determined current. The voltage across the Amerpite Lin-A-trol varies from 20 to 40 volts or 100% with a 10% increase in current. As a result of this singular property of the Amperite to vary very rapidly in current we are able to obtain a regulation on the tube filaments of a receiver.

The Amperite Lin-A-trol consists of an Amperite voltage regulator and an auto-transformer. This combination permits the use of Amperite without any changes in the receiver. When a receiver is built to include Amperite no auto-transformer is necessary. Amperite not only cuts the voltage down when it is high, but raises the voltage when it is low.

The auto-transformer is designed as follows: A typical receiver using 4 UX226, 1 UX171A and 1 UX227 and 1 UX280 tube ordinarily requires 0.45 amperes in the primary of the receiver at 110 volts. When the line voltage is 95 volts the Amperite will have a 20-volt drop across it. The transformer will therefore be required to have a 95 minus 20, or 75-volt primary. An auto-transformer of this type has an efficiency greater than 95%. In order to have the same wattage in the primary as at 110 volts, the current in the 75-volt primary will have to be $0.45 \times 110/75$ or approximately 0.6 amperes. The Amperite for this receiver will pass 0.6 amperes and vary from 20 to 40 volts. We number this Amperite 6-20. An Amperite that will pass 0.7 amperes and has a drop of 20 volts when the line voltage is 95 is called 7-20, etc.

The second requirement of an efficient regulator is that it should not consume too much power. Amperite 6-20 consumes on the average 0.6 amperes x 30 volts or 18 watts which is extremely low.

The third requirement is that the regulator should be compact. When the Amperite is used in a set which is especially built for it, all that is necessary is the Amperite itself. The size of the latter is $1\frac{3}{4}$ " diameter and 3" high which is smaller than a standard a.c. tube. When it is necessary to use the Amperite in conjunction with an auto-transformer, as in the Amperite Lin-A-trol, the space necessary is approximately 4 x 4 x 6 inches. This you will note makes an extremely compact unit.

The Amperite Lin-A-trol therefore consists of an auto-transformer and Amperite which controls the voltage in the receiver to within plus or minus 5%, consumes approximately 20 watts and is extremely compact.

Fig. 2



A Plug Aerial

For sharper tuning and static reduction the Consolidated Wire and Associated Corporations of Chicago has placed on the market the "Plugairial." (Fig. 2.) This neat piece of apparatus is of genuine bakelite, moulded in three parts, and is so designed that it takes the place of the electrical attachment plug. The antenna post of the receiver is attached to the binding post on the end of the "Plugairial." Two outlets are provided on the side of this plug for the use of lamps, etc. The unique feature of this plug is that, after inserting in the lamp socket, the head of the plug may be reversed for better reception by simply pulling out and turning through 180 degrees and reinserting it; this of course without disturbing any appliances which may have been attached to the mid-section of the plug.

Jensen Concert Dynamic Speaker

This new dynamic unit completes the Jensen line, which now consists of three models, the Standard with 8-inch cone, the new Concert with 10-inch cone and the Auditorium model with a 12-inch

Fig. 3

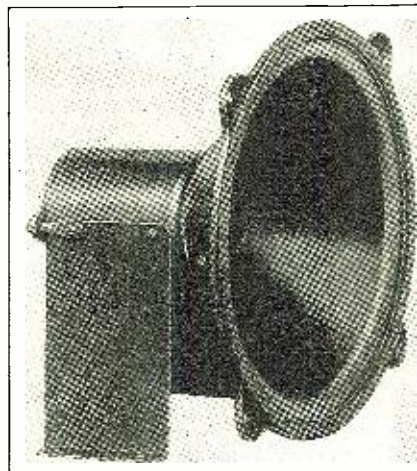

cone. (Figs. 3 and 4.) The new Concert dynamic embodies a number of innovations as far as dynamic speaker design is concerned. Through the employment of an especially prepared and treated material in the cone and the use of a new kind of wire drawn especially for

Fig. 4

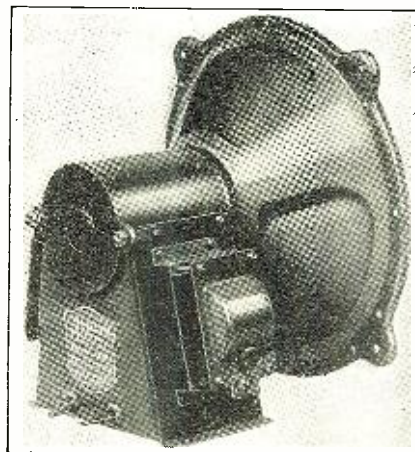

Jensen for winding on the movable coil, great rigidity and strength are maintained but giving at the same time extraordinary lightness and freedom of motion in the actual sound-reproducing mechanism.

The entire range of voice and musical frequencies is reproduced with the same degree of brilliance. The bass notes (as low as 30 cycles) are soft and musical, with an absolute elimination of harshness or the barreled effect which was possibly a just criticism of earlier types of dynamic speakers. The new Jensen Concern Dynamic is built in four types, for operation from 110-volt a.c., 110-volt d.c., 220-volt d.c. and 6-volt d.c. The Concert Dynamic is also offered in the Jensen Imperial Cabinet; this cabinet was announced earlier in the year.

Pacent's New Pick-up

Fortunately for all interested in better reproduction of records electrically through the radio set, engineers working on improved pick-up design have fully appreciated their problem. Three years ago the first pick-ups were made available to the general public at popular prices. Gradually improvements in design went forward, engineers and laboratory men realizing that pick-up design must keep pace, or better, keep ahead of amplifier and speaker improvements.

In the past twelve months engineers and laboratory men have made particularly noteworthy advances in phonograph pick-up design. Basically, the principles used remain the same, but the perfection attained in the latest models has been accomplished by attention to details, highly important, though seemingly small design improvements. The new series 106 Pacent Super Phonovox furnishes a fine example of what has been done to keep electrical pick-up design fully abreast of power amplifier and speaker design. The new models are the result of a year's painstaking and exact research and development work with the electrically cut

Fig. 5

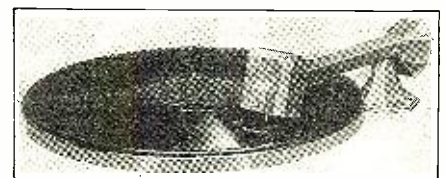

type of record and the most efficient of modern amplifying equipment. (Fig. 5.)

The first consideration to Pacent engineers working in the laboratory on the design of most efficient pick-up to meet present-day requirements was the record itself. Everyone knows what a record looks like, but probably very few people realize the wonderful range of music recorded in the electrically cut type of record. There are low notes down in the range of 100 to 350 cycles. There is the medium range from 900 to 2,500 cycles; finally, there is the high end of the scale from about 2,600 to 5,000 cycles and upwards. To reproduce a record electrically and most efficiently through a phonograph pick-up, the entire range covered by the modern amplifier must be tracked and

passed on to the amplifier in undistorted form.

Engineers working on the new Super Phonovox Series first considered ways and means of bringing out the full bass so welcome to listeners. After extended experimentation, a new principle known as the variable fulcrum was developed which gave them a worth-while increase in frequency range. By this new system, the fulcrum of the armature system does not remain fixed but rather has a certain amount of free play to move crosswise in the record groove, with a lateral motion. Largely due to this new feature in pick-up design, the latest type Super Phonovox is claimed to have the remarkable frequency range from 40 to 8000 cycles, a range considerably greater than that covered by any amplifier.

One of the few criticisms of the phonograph pick-up playing records through radio sets has been bothersome needle scratch. Engineers have worked long hours to lessen the scratch of the needle on the record. The answer to the problem was found during the last year in lessening the natural period of resonance of the armature system and of the pick-up unit as a whole.

Today in the latest type Super Phonovox, needle scratch may be considered a negligible factor.

Engineers working on the design of the new pick-up appreciated the possibilities of reproducing the full bass of the modern electrically recorded record. The secret of bringing out the low notes was discovered after experimentation with many types and styles of counterweighting of tone arms. In final form the pick-up which brings out so remarkably bass music employs counterweighting of special design to bring into play the inertia of the tone arm, giving an extraordinary degree of tracking on the low end of the scale.

The improved type pick-up designed to more than meet demands of 1929 amplifiers and speaker equipment appears externally to be little different from the preceding type. The improvements and advances in design are mostly contained inside the pick-up unit proper, a simple stamped metal case less than two inches square. In this case is the special cobalt steel magnet, the heart of the pick-up system, the armature, and the variable fulcrum which has been found to contribute so much to better rendition of music and speech through the improved audio amplifier of today. The tone arm, of course, plays an important rôle in applying correct weight to the record and in giving complete, exact tracking throughout the run of the record.

International Resistances

The International Resistance Company of Philadelphia announces an interesting development in the form of resistors which are to be supplied to the manufacturing trade as well as to jobbers and



Fig. 6

service stations for use in connection with replacements of resistors in power packs and alternating-current receivers. (Fig. 6.)

The resistance unit is known as their Durham type MF4-2; a very ruggedly made unit, the tinned wire pigtail leads being simultaneously moulded with the end of the unit. The whole provides a resistor that is practically indestructible. Each of the resistors go through an operation which is unique, consisting of the "flashing" of the resistance unit at twice its normal rating; this "flash" load is continued for five minutes. A close degree of accuracy is maintained with all the units, as well as a very low temperature coefficient.

These metallized resistors are supplied in all ranges from 250 to 10,000,000 ohms.

A space-saving "Midget Resistor" is another new product of the International Resistance Company. This resistor is very similar to the type MF4-2 and is known as the Durham type MF4-½. On account of its very compact size, the unit fits in extremely well with the present-day receiver and is well adapted for use with the 222 screen-grid type tubes. The MF4-½ resistors are supplied from 250 to 5,000,000 ohms.

New Pilot Apparatus

A new variable resistor of the compression type, with the resistance range from 40 to about 10,000,000 ohms, has been developed by the Pilot Electric Mfg. Co. of Brooklyn, N. Y. (Fig. 7.) Its wide resistance range and also the ability to handle 20 watts of power make it useful for many purposes in radio receivers. The resistor is absolutely non-inductive and maintains its resistance value. The change from minimum to maximum resistance is made with four turns of the knob. The resistance material is a special non-packing compound contained in a solid piece of brass. The outside of the case reminds one of an airplane cylinder with its air-cooling flanges, which will dissipate any heat that may be generated

Fig. 7

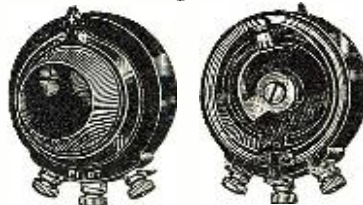

while the resistor is in operation. The new resistor bears the trade name of "Resistograd" and will withstand voltages as high as 500 volts without internal sparking. The Resistograd is 2 7/16" long over all, 1 7/16" in diameter and mounts in a single hole. A number of uses may be found for the unit, such as voltage dividers in "B" power packs, oscillation control in r.f. circuits, volume control in the antenna or audio portion of the receiver, and as a regeneration control shunted across the tickler or in series with the "B" lead to the detector plate. It may also be used to advantage in controlling the local exciting current through a neon-gas television lamp.

Pilot's other new product is known as the "Volumgrad," and is made in four resistance ranges, namely, 0-50,000 ohms, 0-100,000 ohms, 0-200,000 ohms and 0-500,000 ohms. With a Volumgrad of the proper size connected in any one of several places in a receiver, the volume can be adjusted from zero to maximum with only one turn of the knob. The instrument consists of a one-piece moulded case of genuine black bakelite, 2 inches in diameter and 23/32 of an inch thick. The resistance element is a strip of non-hygroscopic material impregnated with a special chemical preparation. It is coiled inside the case, contact to its surface being made by a flexible phosphor-bronze ring slightly smaller in diameter than the resistance strip itself. A button attached to a rotating arm presses a small section of the ring against the strip, making a good electrical connection with it. This unusual arrangement relieves the resistance strip of the frictional wear of the contact arm. The thin phosphor-bronze ring is made to press down lightly on the strip, and does not tend to rub off the surface of the latter. The overall resistance of the strip therefore remains unchanged, and is not affected by constant rotation of the knob. Connections from the ends of the strips and from the contact spring are brought out to binding posts on the periphery of the case. The device may be used either as a potentiometer or as a straight variable resistor. The instrument may be used on metal panels as the brass shaft is insulated from the contact spring it controls. The back of the case is covered with a dust-proof transparent disc of non-combustible material.

The Volumgrad will safely dissipate .125 watt. This power capacity is more than adequate for a volume control device, which is called on to handle currents of only small value. The Volumgrad may be used in some of the following ways: As an antenna potentiometer, controlling the voltage applied to the screening elements of screen-grid tubes; across the secondary of the first audio transformer; as a variable grid leak in capacity-coupled audio amplifiers and as a regeneration control, for this purpose being connected across the tickler coil.



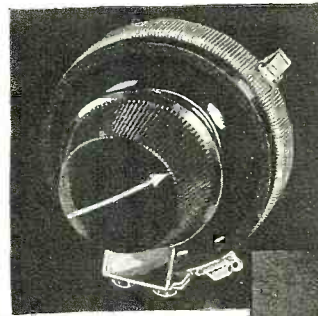

An aeroplane view of the Celoron plant at Bridgeport, Pa.

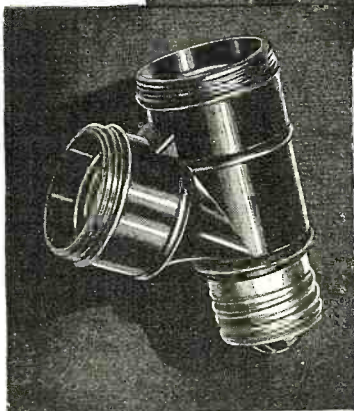
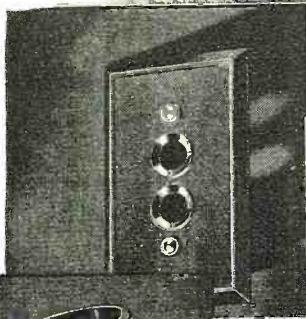
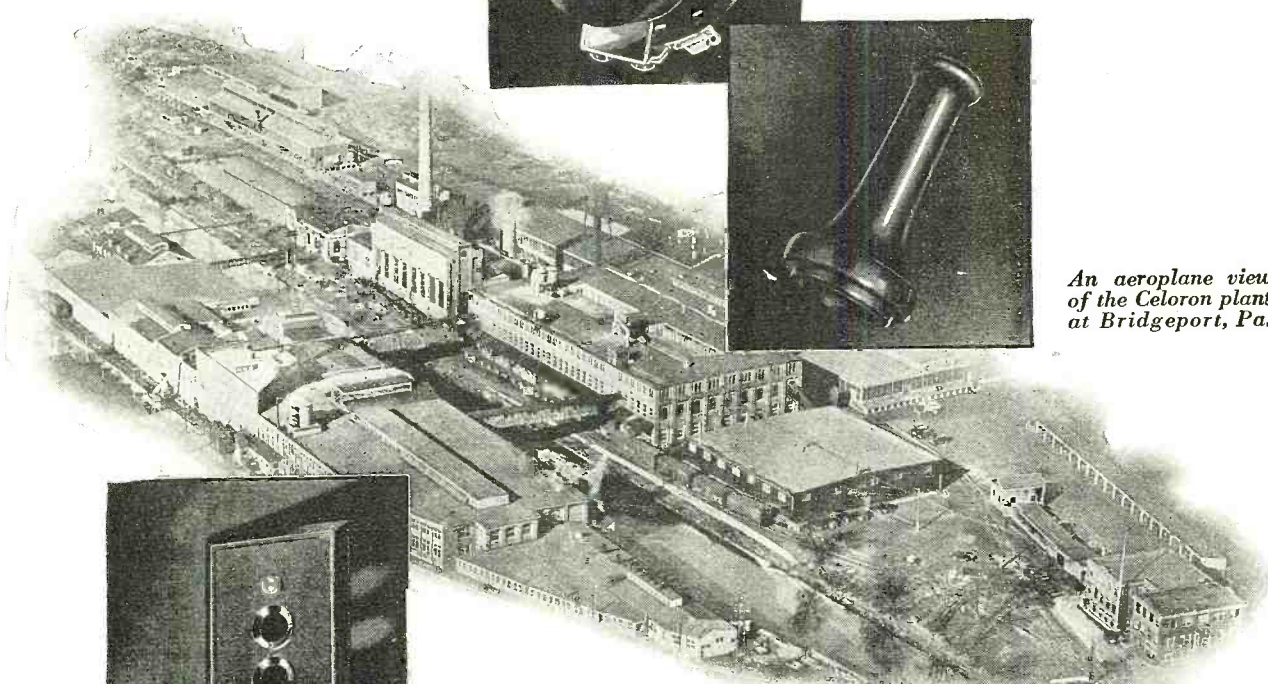

More to sell than just another Molding Powder

When the oldest and largest producers of laminated technical materials in the world developed and adopted a new synthetic resin for the further improvement of their products, you may be certain that this new resin is a decided forward step in the industry.

When every stage of the production of Celoron Molding Powders, now offered to the trade, is under the exacting supervision of the same laboratory that perfected Celoron Resins, you can be sure that the production quality will

remain consistent with the original achievement.

When the Celoron Company with all its enormous resources stands behind every ounce of material that leaves the Celoron plant, you are buying something more than "Just another molding powder." You are buying guaranteed satisfaction — the assurance of your customers' continued good will.

THE CELORON COMPANY
BRIDGEPORT - - PENNSYLVANIA
In Canada: 350 Eastern Avenue, Toronto



Celoron Products

Celoron Molding Powders; Impregnated Fabric and Paper for Molding; Synthetic Resins, Varnishes and Cements; Laminated Celoron sheets, rods and tubes for radio, electrical and industrial purposes; Celoron Silent Gears.



CELORON MOLDING PRODUCTS

EXCELLO Radio Consoles

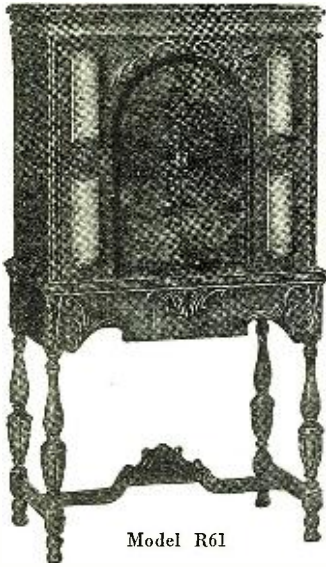

Model R61

A beautiful Walnut Cabinet with sliding doors of matched Butt Walnut and selected Japanese Ash sidepanel overlays. Accommodates Buckingham, Crosley, Atwater Kent, Fada, Sparton and all standard receivers. Ample space for Receiver, Speaker, etc.

Write today for Free illustrated folder of all new styles, including Phono-Radio Combination Consoles.

EXCELLO PRODUCTS CORPORATION
4832 West 16th St., Cicero, Illinois

SHORT WAVES

without the
expense of
a new set!

The Submariner



WILL CONVERT YOUR RADIO SET INTO
AN EFFICIENT SHORT-WAVE RECEIVER

Simply remove a tube from the set and place it in the "Submariner," then insert plug from "Submariner" in the socket from which tube was taken, attach aerial and ground to clips of "Submariner." Write for our money-back guarantee. Enthusiastic owners have written us from all parts of the world. Stations 8,000 miles away have been received. Vernier dial 32 to 1 ratio. Users are getting foreign stations the year around. There is very little static and short waves carry a much greater distance.

FOUR MODELS

20 to 65 meters for battery tubes, \$15.00. For all electric, \$17.50. Interchangeable coil model, 10 to 160 meters, \$22.50, for A.C. or D.C. receiver. No. 4 coil, 160 to 340 meters, \$2.00 additional. In ordering, be sure and state name of set and the number on each tube. Ask your dealer for one. If he does not carry them, he will get one for you.

If you are unable to get one locally, it will be sent postpaid upon receipt of money order or certified check. Sent C.O.D. only if \$1.00 accompanies order. This is to insure carrying charges. Price in Canada and some other foreign countries, 60c. additional. Cannot be sent C.O.D. outside U. S. ORDER TO-DAY.

J-M-P MANUFACTURING CO., Inc.
3413 Fond du Lac Ave. Milwaukee, Wis., U. S. A.

Exide

RADIO BATTERIES

Manufactured by
THE ELECTRIC STORAGE BATTERY CO.
Philadelphia

Communication Securities

The Remarkable Growth of Electrical Communication Throughout the World Has Made the Securities of Wire and Radio Companies Extremely Valuable

By ALFRED M. CADDELL

CONVERSATION, it seems, has become one of the major businesses of the world; that is, the kind of conversation that people pay to engage in. And supplementing conversation are electrical facilities extending to the four corners of the earth to carry on communication by code via cable and radio. On land and sea and in the air, man may, or soon will be able to, communicate with his fellow man anywhere, everywhere, almost instantly. And the achievements of today are but an indication of what is coming tomorrow. For the electrical transmission of sight is not now the impossibility it was considered years ago.

Only recently has two-way telephonic communication between aircraft and the ground been satisfactorily established. Within the last few weeks the first steps were taken to establish telephonic communication between ships at sea and sta-

tions with their associated wire services on land. Passengers on a speeding Canadian express train have also recently engaged in conversation with their homes or distant offices. And with beam radio and facsimile radio, and television and home reception of synchronized pictures and sound; the transmission of power or the radio control of power to govern transportation on the land, sea and through the air, and with many other discoveries most certainly to be developed into actualities in the limitless future, who today can be limited in his perspective when viewing the immensity of the electrical communications field?

In a St. Louis home, or a Cleveland home, or a New York City apartment, Mrs. Alberta Jones, let us say, desires to speak with Mr. Albert Jones in stateroom A-127 of the *Mauretania*, which is speeding toward Europe on the high seas. Picking up her telephone receiver, she puts in the call, which is routed by telephone traffic operators to the radio-telephone station, where the call is flung far out over the ocean expanses to the ship at sea. The ship phone operator gets the call, rings stateroom No. A-127, Mr. Jones gets on the wire and the conversation begins. The telephone connections, relays and all the workings of the system are so technically perfected that the realistic conversation for a time challenges the credulity of the conversationalists.

On another occasion, perhaps, Mr. Jones is speeding westward on a train that left New York at 2:45 P. M. Tuesday. Or he is somewhere in flight between St. Louis and Frisco. Perhaps he wants to converse with Mr. Smith in the home office in New York. He picks up the receiver in the plane or train and hears the familiar "Number, please?" of the operator at the nearest land radio station. "I want to talk to Mr. Smith at Worth 0000, New York," he says. "All right, we'll call you," replies Central, who thereupon proceeds to route the call over the long-distance land wires.

Futuristic, you say? Not when it is recalled that today via the land wire and trans-oceanic radio telephone service a man may sit in his office or home anywhere in the nation and talk to any other person who has a telephone in the British Isles, France, Germany, Sweden and other European countries. The only limiting factor in the extension of plane, train or ship service is the scarcity of wavelengths by which to conduct operations. But, as with land lines, soon we may have multiplex or other ingenious facilities for more scientifically apportioning the use of the various radio waves.

Years back, the telegraph and the telephone had to fight their way into public favor as regards both patronage and finances with which to carry on develop-

REALIZING that the present and ever-increasing distribution of securities is a subject in which millions of people in America and throughout the world are deeply interested, the editorial director of RADIO NEWS has decided to include meritorious articles on this subject of finance in this and subsequent issues.

The accompanying article tells the story of the rise of the great communication companies and touches upon various classes of communication securities. It will be followed with articles setting forth every phase of the investment structure, in which articles the safety of investments will constantly be stressed.

As an added service to readers of RADIO NEWS, authoritative information regarding any security will be published in these columns and also supplied to inquirers. Every letter of inquiry should contain the name and address of the writer and a two-cent stamp (preferably a stamped, self-addressed envelope) for reply.

Address: The Financial Editor, RADIO NEWS, 381 Fourth Avenue, New York, N. Y.

ment work. Less than ten years ago some folks labeled radio broadcasting "a fad that will soon die out." But today everyone is familiar with the remarkable development of this phase of electrical communication. Profiting from the experiences of the past and with better statistics available of the possibilities of growth, thousands of investors have now pinned their faith on the future of electrical communication; either in the securities of companies manufacturing electrical equipment and devices or in the companies conducting various branches of the operating services.

From the standpoint of investments, the following classifications may serve as a background for the analysis of securities:

1. The manufacturing of electrical apparatus, including radio sets and parts, television sets, allied electrical devices, facsimile apparatus, etc., etc., for (a) commercial communication purposes; (b) sale to the public for home use.

2. Operating companies in the wire telegraph, cable, radio telegraph and telephone, wire telephone and allied lines.

(Continued on page 186)

The S. W. Four

(Continued from page 114)

this control properly only a small amount of actual experience is needed to master its sensitiveness.

COMPLETE PARTS LIST

- 1 S.-W.-Four foundation unit, comprising:
- 3 Alcoa shield cans, drilled;
- 3 bakelite sub-bases, drilled;
- brass posts for coil sockets, hardware, binding posts, pin plugs and jacks;
- 5 Aerovox fixed condensers, C3, C4, C5, C7, C9; .006 mfd.;
- 1 Aerovox fixed condenser, C6, .0001 mfd.;
- 1 Aerovox fixed condenser, C8, .002 mfd.;
- R1, Yaxley fixed resistance, 5 ohms;
- R2, Yaxley fixed resistance, 10 ohms;
- R3, Aerovox grid leak, 3 meg.;
- R4, Carter fixed resistance, 4 ohms;
- R6, Carter fixed resistance, 2 ohms;
- R7, Aerovox grid resistor, 100,00 ohms;

ADDITIONAL PARTS REQUIRED

- C1, C2, Cardwell taper-plate, variable condensers, type 167-E, .00015 mfd.;
- R5, Carter Hi-ohm variable resistance, 100,000 ohms;
- T1, T2, Amertran audio transformers, type AF-8;
- L1, L2, Eight S. W. Four plug-in coils (2 for each wave band);
- V1, UX222 tube; V2, 112A tube; V3, 201A tube; V4, 112A or 171A tube;
- Two National Dials, type B;
- Four Benjamin sockets;
- Two De Jur 5-prong sockets (for coils);
- One Yaxley Battery Switch, No. 10.

Their Genuine Goodness Is Plain to All Who Have Tried Them

BACK of every Electrad product is a world-wide reputation—a reputation won through superior quality and service, plus right prices.

Whether your radio problem is one of choosing proper resistances for your eliminator or power-pack—or the control of tone and volume in your receiver, you can pin your faith to Electrads.

Electrad specializes in voltage controls for every radio purpose, including Television.

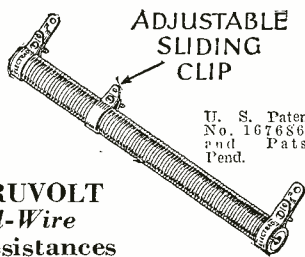

ADJUSTABLE SLIDING CLIP

U. S. Patent No. 1676869 and Pats. Pend.

TRUVOLT All-Wire Resistances

Distinctive air-cooled open winding provides unusual ventilation and compactness. Voltages are accurate and stable. Sliding clip, an exclusive Electrad feature, provides accurate setting at desired value. 22 stock sizes.

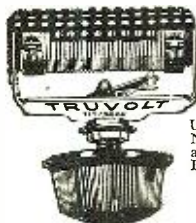

U. S. Patent No. 1676869 and Pats. Pend.

TRUVOLT VARIABLES

Simplify Eliminator construction by easy, stepless variation of voltage. The contact arm glides endwise over the resistance wire. This gives unusually fine regulation and lessens wear. One-hole mounting. 22 stock sizes.



U. S. Pats. 1034103—1034104 and Pats. Pend.



SUPER-TONATROL

A new Electrad development for controlling volume in high-powered receivers. Practically all-metal construction gives unusual radiation. Easily dissipates five watts. Resistance element fused to enameled metal base. Pure silver floating contact gives astonishing smoothness and service that will outwear the average receiver. \$2.40 each.

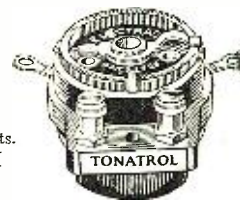

U. S. Pats. 1533658—1034103—1034104.

TONATROL LINE

Electrad wire-wound Tonatrols are the best of their type for regulating volume and tone in most receivers. Smooth action, long wear. A really fine precision instrument. With or without filament switch attached. \$1.50 to \$3.00.

ELECTRAD, INC., Dept. RN8
175 Varick Street, New York
Send me literature on—TRUVOLT Resistances—TONATROL Volume Controls—Super-TONATROL.

Name.....
Address.....

ELECTRAD INC.

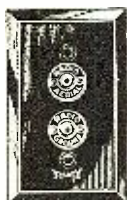

Wire Your Home for Radio

For every radio need, in brushed brass or Bakelite. Fit standard electrical switch or outlet box. Single plates and in gang in many combinations.

- No. 135—For Loud Speaker.....\$1.00
- No. 136—For Aerial and Ground.... 1.00
- No. 137—For Battery Connections... 2.50
- No. 138—For A C Connections..... 1.00

(Bakelite, 25c additional per plate)
YAXLEY MFG. CO.
Dept. N. 9 So. Clinton Street, Chicago, Ill.

SET BUILDERS Get this Book



Barawik, the first and oldest radio specialty house, offers you unusual service this year. Bigger stocks, quicker shipments, lower prices. Deal with an old established, reliable house. Get honest goods, honest service, honest prices. **Barawik** service makes you more money. Send now for big new Catalog showing lowest wholesale prices.

BARAWIK CO. CHICAGO, U. S. A.

28-C Canal Sta.,
Mail This Coupon Now for Free Radio Guide

Name.....
Address.....

What Are the Facts About Television?

(Continued from page 127)



JULES VERNE'S TOMBSTONE AT AMIENS PORTRAYING HIS IMMORTALITY

Jules Verne Comes Back to Life!

A MAGIC name—Jules Verne! A name that has brought untold joy to untold millions.

Who can fail to remember his famous novels, "Twenty Thousand Leagues Under the Sea," "From the Earth to the Moon," "To the Center of the Earth," and other equally imaginative triumphs of this world-renowned novelist? Few writers have ever equalled Jules Verne's vivid imagination, and still fewer have been able to paint these pictures of the mind so brilliantly in printed words.

And now Jules Verne comes back to life! Comes back with stories that increase your pulse and make your heart pound. For in **AMAZING STORIES**, the magazine of scientific fiction, the famous school of authors who have followed in Jules Verne's footsteps now offer you the fertile fruits of their imagination. In their colorful minds, the inventions and discoveries still to come are already here. They write of a voyage to Venus, that silvery star seen so often in the evening sky; of correspondence with a mythical people on Mars; of radio messages from still more distant planets; of giant insects and of people who have huge heads and no bodies; of the things a man might well see and hear a thousand years from now!

It's a thrill you've never had! For it deals with the Future, and the things your children's children may some day actually experience and enjoy.

Get the next 6 Big Issues of **AMAZING STORIES** delivered to your home by the postman. Read with a relish these profusely illustrated stories of a weird, but not impossible, future.

As a special inducement we offer all 6 Big Issues for a single \$1. (The news-stand price is \$1.50). And if you are not convinced **AMAZING STORIES** is worth twice the price, after reading the first issue, we will let you keep it **FREE**, and send your dollar back.

Sit down right now and fill out the coupon below. It is your insurance against dull evenings from now on!

Simply Clip and Mail Coupon

AMAZING STORIES,
Dept. 2408S, 381 Fourth Ave.,
New York, N. Y.

Gentlemen:
I enclose \$1, for which send me your next 6 issues of **AMAZING STORIES**.

Name.....

Street.....

City..... State.....

If the drum is increased to 10½ in. diameter and turned six times per picture, the picture is 4 in. square; magnified, it appears about 10 in. square, and 12 to 15 people can watch it.

The light intensity is the intensity of the tiny cathode source, which, because it is so small, requires but little current for a definite light intensity and a given size picture, the picture generated by the outer ends of the quartz rods being a virtual magnification of the light source.

The light source need be but little larger than the elementary area of the picture, for the arcuate movement of the outer end of each quartz rod through

stand still. If he does not see a picture, the speed is not correct, and he turns the adjusting screw until he has a picture in frame. Synchronism in radiomovies is much more simply attained than in still pictures. We also have automatic synchronizers, but they are no part of this drum description.

Looking to the possibility of future development in this art, may I again cite for consideration the impeding fundamental in this method of picture production, namely, that each elementary area is lighted, if and when it is lighted, only 1/2304th part of the whole time.

Obviously, therefore, in the case of the

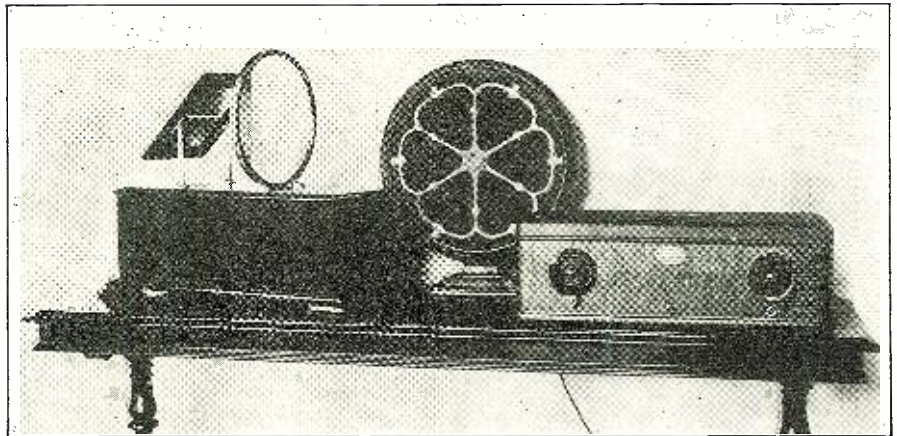

ILLUSTRATION SHOWING RELATIVE SIZE OF JENKINS RADIOVISOR AND A STANDARD RADIO SET

which the light is flowing is comparable to the movement over the picture area of this small light source itself.

An increase in the size of the picture does not, therefore, require an increase in the light source, namely, the size of the cathode, but only a lengthening of the quartz rods; for the width of the picture is determined by the length of the arc of the angle subtended by radially-adjacent quartz rods; and the height of the picture by the number of parallel lines, each the locus of the outer end of a quartz rod from which the light emerges undimmed by its distance from the source in the hub of the drum.

The motor we most use to turn the drum is just a 60-cycle synchronous motor, for there are more homes in the a.c. district of cities than in the d.c. district. Even the slight frequency differences in the 60-cycle current of separate cities often gives little trouble in the 1/15th of a second that it takes to complete each picture of the composite movie story. We have tried synchronous motor transmission and reception between Chicago and Washington successfully, and also between Washington and New York. Radiovisors for use in d.c. districts are fitted with a d.c. motor with an adjustable friction-control with quite acceptable success. Someone adjusts the drum speed as he watches the picture. If he sees a picture at all the receiver is in approximate synchronism with the transmitter; a little further adjustment makes the picture

single plate cathode neon lamp scanned by a disk, the current required is at least twenty-five hundred times more than it need be if it were possible to apply all the light to each elementary area in succession.

It will readily be seen that my drum method is a step in this direction. And while we have made a great gain in the multiple-target-lamp-quartz-rod combination, we are still a long way from my ideal.

And please let me remind you also that the apparent intensity of illumination of the whole picture is the intensity of the light coming to the eye from a single elementary area, divided by the elementary time fraction, which is also equal to the number of elementary areas, namely, 2304. That is why the picture seems so dully lighted when the machine is running, though the scanning spot is very bright when the machine stops.

Multiplying this light reduction by the fractional inefficiency of the current, it will be seen that the total current-light efficiency on the eye in the scanning-disk method is less than 1/50,000th of one per cent.

Doubtless, this discouraging handicap is one of the factors which has delayed the art so long in coming into useful service.

But I am confident the solution is possible. For example, I am attacking the problem in still another way, namely, by substituting persistence of light for persistence of vision.

This new principle is incorporated in a receiver now building, in which the light of each elementary area persists for an appreciable time, say, 1/10th of a second after the exciting current has passed on.

Actual tests of the fundamental mechanisms involved have convinced us that we shall have more light available than is now employed for illuminating present picture-theatre screens. And the light is white light, not neon pink; and fortunately the light source is readily available in the open market.

This same principle applied to picture transmission, namely, the substitution of persistent for transient elementary area illumination, will be an important contribution toward bringing into the home the long-promised radiovision reception of inaugural ceremonies, baseball games, flower festivals, mardi-gras, and baby parades.

The War Correspondent Takes to the Air

(Continued from page 139)

non-combat aircraft. While we could make out the ground fairly well at one thousand feet, visibility on a level of the plane was next to nothing. We realized this when three pursuit planes suddenly zoomed out of the mist, and missed us only by skillful banking on the part of their pilots. With this visibility, anything coming head-on would hit us in the split fraction of a second it would require to cover the few hundred feet of visibility. So we signed off, and returned to the airport.

Sunday, May 27th: Armistice declared!

The Analogy Between Radio and the Talking Pictures

(Continued from page 135)

space, then added telephony to his art, next mastered the subtleties of acoustics, and finally threw all his acquirements into the pot with the equally precious contributions of the bright boys of the movies. Yet, as we have seen, the inevitable steps in the development are clearly traceable, and the amplifiers have not changed so much in the last five years.

Putting the Portables Through Their Paces

(Continued from page 131)

were no pronounced hills and no trees; the mystery was apparently due to some freak of ground conductivity, in spite of the fact that we used counterpoises instead of conductive grounds.

But if things are not understood, so much more are they a challenge to the inquisitive mind. The greatest scientific joy is in treading a pathway not beaten too level by the feet of countless predecessors; in finding perhaps some few grains, however trifling, of universal truth.

It's Here! the Tuned Underground Aerial for Better Reception

Here's great news! For the same cost as an ordinary overhead aerial you can now enjoy greatly improved reception and be through once and for all with the old-fashioned, inconvenient, noise-gathering roof aerial. There has been such a great demand for an improved underground aerial that for over a year we have kept engineers busy designing, testing and perfecting a satisfactory device. The result is the new amazing SUB-TONE. It is designed to decrease static and noise, get finer selectivity and give true radio enjoyment, by virtue of Tuning the underground aerial to the radio circuit.

With an untuned aerial, frequently the sensitivity of the set is not great enough to give the broadcast signal a predominating strength over the existing noise level. As a result, static predominates and the set is unable to get the desired broadcasts.

With Sub-Tone, the aerial is tuned to the broadcast being received. This allows the broadcast signal to have greater strength than the static and noise. Finer selectivity is allowed and reception is clearer and more enjoyable.

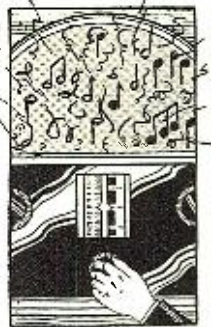

It's So Simple a Child Could Install It!

Takes but a few minutes. Just dig a small hole and place the aerial in it. Sub-Tone is also equipped with a scientific ground plate, so that you can take care of antenna and ground in one simple operation. The lead-in wires are brought to the set—the aerial wire connecting first to a binding post on the Tuner, a small, compact device that can be placed in the radio cabinet or any convenient place near it. Your aerial is out of sight and protected from lightning, soot, wind and interference. You avoid many aerial troubles with the use of Sub-Tone.



Sub-Tone Works on A.C. or D.C. Sets or Sets Operated with Batteries or Battery Eliminators

The purpose of Sub-Tone, the marvelous new Underground Aerial, is to bring in the radio broadcasts you want to hear, clear and without interruption, and with the greatest possible convenience.

Try SUB-TONE On Your Own Set FREE!

You don't need to take our word for the merits of Sub-Tone—we want you to try it and prove to yourself what tests and reports from users have already proved to us. Put in a Sub-Tone entirely at our risk. Just hear the difference and judge for yourself! If you aren't delighted with the improvement, the trial doesn't cost you a cent. Send for all the startling information on Sub-Tone. You've a surprise waiting for you. Write today!

BETTER RADIO PRODUCTS

141 W. Austin Ave., Dept. 827-L.T., Chicago, Ill.

BETTER RADIO PRODUCTS, 141 W. Austin Ave., Dept. 827-L.T., Chicago, Ill.

Rush details and proof on Sub-Tone, the new Tuned Underground Aerial, and how I can test it free.

Name.....
Address.....
City..... State.....

Prevents Current Wobble

Install Amperite for every tube and smooth out "A" current wobble that ruins reception. Amperite adjusts itself to the exact need of each tube. A type for every tube—A.C. or D.C.

\$1.10 with mounting (in U.S.A.) at all dealers.

Radiall Company
50 FRANKLIN ST., NEW YORK

FREE "Amperite Blue Book" of modern circuits and valuable construction data. Write Dept. RN-8

AMPERITE
REG. U.S. PAT. OFF.
The "SELF-ADJUSTING" Rheostat

SET BUILDERS
Get this Book

LATEST RADIO GUIDE FREE

Barawik, the first and oldest radio specialty house, offers you unusual service this year. Bigger stocks, quicker shipments, lower prices. Deal with an old established, reliable house. Get honest goods, honest service, honest prices. Barawik service makes you more money. Send now for big new Catalog showing lowest wholesale prices.

BARAWIK CO. CHICAGO, U.S.A.
28-B Canal Sta.

Mail This Coupon Now for Free Radio Guide

Name.....
Address.....

The Theory and Design of Band-Pass Filters

(Continued from page 141)

NEW
NORDEN-HAUCK
MODELS
ARE
NOW READY
 Super Electrophonic
 Shielded Super-10
 Super Dynamic Speakers
 Power Packs
 Short-Wave Apparatus
 Etc.

Write Today for New Literature

NORDEN-HAUCK, INC.
 Engineers
 Marine Building
 Philadelphia, Pa.

in operation; the condition that the band pass is greater on the higher frequencies (lower wavelengths) than on the lower frequencies (higher wavelengths). We made mention of inductive reactance in an earlier paragraph and this term is naturally applicable to the mutual inductance M . Increasing the coupling reactance is the equivalent of increasing the value of inductance, which in turn is the equivalent of increasing the coupling. With a fixed value of inductance and a variable frequency, we find conditions similar to a fixed frequency and a variable inductance, since reactance is a function of frequency. Hence, the state of increased band pass as the frequency is increased, since the coupling reactance in-

than the resonant frequency, the reactance rises to very high values, perhaps infinity, and this would belie the flat top or the approximation of the flat top secured in the band pass filter. One would naturally expect a sharp dip between the two resonant peaks when the mutual reactance is present and causes the two peaks. The sharp dips, however, are eliminated by the resistance of the circuit, which makes impossible zero reactance at resonance and infinite reactance at other values of frequency. Hence the flat top, or approximation thereof. With respect to the width of the band pass, the governing factor is the design of the mutual inductance or reactance with respect to the number of turns comprising the winding. It is also important that the coupling be-

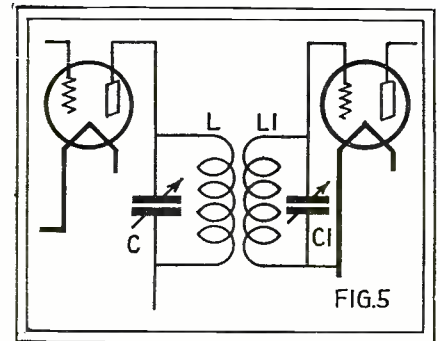
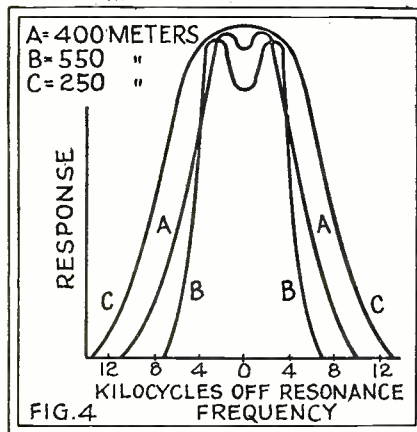

6 Ft. LONG

FREE!

Boys! Here's the great Navy model Airship. Large 6-foot air bag with inflators, parachute with automatic release and complete instructions for flying. Will fly for miles at height of 1000 feet. Great chance to study aerial navigation. Send name and we'll send 6 of our new art pictures to dispose of on special 25c offer. Send the \$1.50 you collect and as a reward for this service we will send this wonderful Airship with full instructions free.

C. M. THOMAS, 337 W. Madison St., 8-K-22, Chicago

LEARN TELEGRAPHY WITH TELEPLEX

Be an expert Morse or Continental code operator! **BIG PAY** — TRAVEL — FUN — ADVENTURE. After a few short weeks of practical study with Teleplex you will be an expert operator. This amazing instrument teaches you right in your own home. Works like a phonograph. No knowledge needed—beginners learn at once! **NOT A SCHOOL. Free 10 days' trial.** Write for **FREE** booklet H-11.

TELEPLEX CO., 72 Cortlandt Street, New York City

Send for WESTERN RADIO
New 1929 Catalog

LATEST and FINEST nationally known A.C. sets, consoles, cabinets, speakers and accessories at **LOWEST PRICES.** Catalog sent **FREE** on request.

WESTERN RADIO MFG. CO.
 128 W. Lake Street, Dept. RN-8, Chicago

AERO-CALL
 Factory - Built, Short-Wave Converter, Filtered, Shielded. Plugs Into Any Radio Set. Two Models. A.C. and D.C., \$25.00.
 Write for literature

AERO PRODUCTS, Inc.
 Dept. 189, Chicago, Ill.

4611 E. Ravenswood Ave.,

creases as the frequency is increased, and is the equivalent of closer coupling between the two circuits. The reverse is naturally true as the frequency is decreased or as the unit is adjusted for operation on a wavelength higher than the 400-meter standard. As the frequency is lowered (the wavelength increased) the coupling reactance decreases and the points of resonance move closer together and the width of the band pass is reduced. See Fig. 4, A, B, C.

We made mention that the value of coupling or coupling reactance governs the band width. If the coupling is of such nature that the circuits are independent of each other and tune to the same wavelength, the reactance of the total selector circuit will naturally be zero, since $XL = XC$ and their effects oppose each other. At frequencies other

tween the two circuits be via the mutual inductance and not inductive coupling between the coils themselves.

Mention of the latter arrangement reminds the writer that it is in use in a commercial receiver. Here, the mutual inductance is not a physical inductance consisting of a certain number of turns, but definite fixed coupling between the primary and secondary windings of a double tuned transformer; i.e., a transformer employing a tuned primary and a tuned secondary as in Fig. 5. This system is employed with screen-grid tubes. The coupling is fixed at a predetermined value, arranged for a definite band pass at a certain frequency or wavelength. In this arrangement, as in the conventional band pass system, the mutual reactance represented by the coupling between the two coils increases as the frequency is increased and the width of the band pass increases.

IN a few short years radio broadcasting has become not only a major source of entertainment and information for forty millions of radio listeners in the United States, but it has also reached industrial proportions of the front rank. For between radio manufacturers, radio distributors and radio broadcasters, the new art now represents a plant investment of nearly a quarter of a billion dollars, with an annual payroll approaching the same amount.

The broadcasting stations alone total \$25,000,000 in plant equipment. A modern 5 k.w. station, for example, costs \$150,000 to install, and a 50 k.w. station involves \$250,000 to \$350,000 in investment. At least seventy-five hundred

people are employed in the country's broadcasting operations alone, representing an annual payroll of \$15,000,000.

Invested in the manufacture and distribution of radio sets, reproducers, tubes, and accessories, there is now a total of about \$210,000,000, according to careful estimates based upon studies of individual manufacturers' figures. These factories and distributing plants employ altogether 100,000 persons, who receive \$200,000,000 annually in salaries and wages.

The industry's total annual payroll is thus \$215,000,000, or a daily payment of two-thirds of a million dollars.—O. H. Caldwell, before the Connecticut Chamber of Commerce.

IN THE AUGUST ISSUE OF
AMAZING STORIES

BARTON'S ISLAND, by Harl Vincent. In his previous story, "The Seventh Generation," Mr. Vincent just gave us an inkling of what he was capable of doing with a theme dealing with the future. He bases his ideas of the future on present political and scientific trends and draws a realistic picture of what may come.

OUT OF THE VOID, by Leslie F. Stone. A serial in two parts (Part 1). With such inventions as perm-alloy and the strides which are made in the field of aviation, we can look with less cynicism on the possibilities of interstellar flyers. The description of such a ship in this story is excellent and the trips and adventures had on this space-flyer are extremely fascinating.

THE ETERNAL PROFESSORS, by David H. Keller, M.D. Just because one member or one part of the body becomes incapacitated through disease doesn't seem sufficient reason for the complete elimination of the entire body. Some things have been written on the subject before, but Dr. Keller, in his well-known manner, strikes the subject definitely and with much understanding.

THE DIMENSION SEGREGATOR, by J. Harold Click. Much has been written about the mysterious fourth dimension, but it remains more, rather than less, mysterious. This new author's idea about it is incontestably good. In order to learn about the fourth dimension, it is necessary to know more about the second dimension. Logically it must be so. It is a good idea unusually well handled in every way.

THE WAND OF CREATION, by Stanton A. Coblenz. Synthetic life might some day become an established matter—so much experimenting is being done in that field now. How desirable successful experiments in this field would prove is another matter. And an interesting version of one dangerous possibility is excellently written into this story.

THE GRIM INHERITANCE, by Carl Clausen. It is almost appalling when you consider the deleterious effect a minute defective ductless gland can have on the well-being and health of an individual. The endocrine gland is particularly interesting and the author of this story has aptly used it in a scientific detective story of definite merit. Crowded out of the July issue.



The Very
Meter
You Want
Most!

Take Your Choice
of 9 Instruments!

YOU finish building a set or power pack. You want to test it for voltage and current. You need some particular meter to make the test complete. Always the necessity for that meter, like recurring hunger! What wouldn't you give to have that meter here, NOW! No more need to endure such irritating deprivation. You are hereby given your choice of any one of nine different meters free! Please use the coupon.

CHOOSE ONE OF THESE NINE METERS!

- | | | |
|---|--|---|
| <input type="checkbox"/> 0-6 Voltmeter D.C. No. 326 | <input type="checkbox"/> 0-10 Amperes D.C. No. 338 | <input type="checkbox"/> 0-100 Milliamp. D.C. No. 390 |
| <input type="checkbox"/> 0-50 Voltmeter D.C. No. 337 | <input type="checkbox"/> 0-25 Milliamp. D.C. No. 325 | <input type="checkbox"/> 0-300 Milliamp. D.C. No. 399 |
| <input type="checkbox"/> 6-Vt Chge Tester D.C. No. 23 | <input type="checkbox"/> 0-50 Milliamp. D.C. No. 350 | <input type="checkbox"/> 0-400 Milliamp. D.C. No. 394 |

Put a cross in the square next to the meter you desire, and fill out and return coupon below.
All meters except No. 23 are panel mount types; size of hole, 2 5/64"

WHAT RADIO COMPANIONSHIP DO YOU ENJOY?

ARE you meeting weekly the best minds of radio? Do you keep abreast of all the new circuits, the intimate details on perfecting existing sets, and get the inside track on sensitivity, distance reception, tonal quality, and how to achieve them? Do you keep fully abreast of the news of radio, technical and non-technical? If not, here is your chance to enjoy the writings of Dr. Lee De Forest, McMurdo Silver, J. E. Anderson, Herman Bernard and a host of other radio engineers who contribute their knowledge to you through the medium of Radio World, the first and only illustrated national radio weekly (eighth year).

You will find Radio World specializes in most intimate revelations of the ins and outs of the best circuits, with technical accuracy second to none. Enjoy the weekly companionship of Radio World's famous contributors, and glean the news of radio, from the four quarters of the earth.

Short waves? Radio World will tell you all about them. Extremely sensitive broadcast receivers? Their construction and operation are fully discussed with confident regularity. Power supplies—push-pull or otherwise? AC receivers? Screen grid tubes? Large receivers that give a super-abundance of performance—small, economical receivers that give performance out of all comparison to their size? Automatic volume controls? Band-pass filters? New tubes? Are you interested in these? Then you're interested in Radio World. Send \$1 now for 8 weeks subscription, one copy a week (regularly \$1.20) and meter you select will be sent FREE!

RADIO WORLD, 145 W. 45th St., N. Y. C.
Published Weekly—All Newsstands—15c copy—
\$1.50, 3 months—\$3, 6 months—\$6 a year.

RADIO WORLD
145 West 45th Street, New York City
Just East of Broadway

Enclosed please find \$1 for which send me Radio World for eight weeks (one copy each week), and also send me FREE, at once, the one meter checked below.

- | | | |
|----------------------------------|----------------------------------|----------------------------------|
| <input type="checkbox"/> No. 326 | <input type="checkbox"/> No. 338 | <input type="checkbox"/> No. 390 |
| <input type="checkbox"/> No. 337 | <input type="checkbox"/> No. 325 | <input type="checkbox"/> No. 399 |
| <input type="checkbox"/> No. 23 | <input type="checkbox"/> No. 350 | <input type="checkbox"/> No. 394 |

Name

Street Address

City State

5-DAY MONEY-BACK GUARANTEE

End a Hard Day
With a Laugh

See what you can do with this fascinating new game—called "Cookoo Nuts." It will take your mind off the troubles of a hard day—you can play it alone or with friends. Price only 25c.

Everybody knows C. M. Payne, the famous cartoonist and originator of S'MATTER POP. Here is a book full of comics, selected for its ability to provide a chuckle a page. 50 funny comic strips all in a single copy—wonderful to show the kiddies. Price only 25c.

"COOKOO NUTS" "S'MATTER POP"

Write Dept. 2408i
Experimenter Publications, Inc. 381 Fourth Ave., New York

Canada's New Automatic Radio Beacons for Marine Service

By JAMES MONTAGNES



This HAMMARLUND Drum Dial

Will Add Lustre
to Your Receiver

Not only beautiful, but beautifully made. Embossed bronze escutcheon, illuminated scale and a mechanism that delights with smooth operation, free from lost play. The control knob (black or walnut) can be placed in any position on the panel. Your dealer sells it—\$4.00 each.

Write Dept. RN8 for
Complete Description

HAMMARLUND MFG. CO.
424-438 W. 33rd St., New York

For Better Radio
Hammarlund
PRECISION
PRODUCTS

The Master Magician Now Exposes the Secrets of Magic

At some time during your life you probably touched the borders of what you thought was real magic. Now you can learn the secret forces which acted to give you that queer spine rippling sensation.

Here, within the 116 pages of this authoritative book, Houdini, the World Famous Magician, explains, with words and pictures, most of the unusual things that people see at spiritualistic meetings on the stage and elsewhere.

Amaze Your Friends with These Feats of Wizardry

It is a book as instructive as it is interesting. Many of the tricks exposed you can also do to mystify your friends. The book is the large 9 by 12-inch size, printed on fine English finish stock with two-color cover.

And the Price Is Only 50c

We don't know of any book anywhere that can be compared with it at five times the price! Send for it today!

Write

Experimenter Publications, Inc.
Dept. 2408b
381 Fourth Ave., New York, N. Y.

IN the wireless room of the England-bound *Duchess of York* four men sat listening attentively to groups of dots and dashes which poured out of the loud speaker on the shelf. They had been sitting there for quite a while, waiting for these high-pitched notes to come out of the air. The group comprised four men of different callings in life, yet each with the same interest in those signals. They did not sit back in their chairs as the notes came in, they leaned forward a little as if to hear them better that way. And through the mind of each raced simultaneously a picture of the place of origin of those signals.

Some months previous to this scene a number of big packing cases had left the government radio test room at Ottawa. Their destination was a lighthouse on a small island off the coast of Nova Scotia; one of the many rocks in the ocean, known as Seal Island, near that ever dangerous Cape Sable. An engineer had sped eastward from Ottawa at the same time, had superintended the unloading of those cases, had gone in the small boat with them and had seen to their safe arrival on the small rocky obstruction in the water which was called an island.

A man had come down the small beach

to greet him, from the lighthouse which was visible for quite a distance out at sea. Together they had helped the sailors bring the cases to the lighthouse and into a room on the lower floor.

A few days later the lighthouse keeper had heard the first of those groups of dots and dashes to which the four men on the *Duchess of York* listened some months later. He had marvelled at them, for no human hand had fashioned them. To him, the whole thing was much too complicated. He was told by the engineer from Ottawa that all he had to do to keep those dots and dashes going into the air, was to put water in the radiator of an ordinary motor car engine, fill its tank with gasoline whenever it ran low, and wind a clock once a week. That was all. In case he should hear a bell ring in the machine, he was to open a door, take out one of the four radio tubes (the one that did not light) and replace it with a spare. Then the dots and dashes would go on again.

Now, these four men at sea were listening to the dots and dashes sent out by the machine in a room of this lighthouse. One of them was a deputy minister in the Canadian government, another the man in charge of radio for the Dominion, the third one of the chief radio engineers of the Canadian government and the fourth was the radio operator of the ship.

They were listening to the first of eighteen automatic beacons which the Canadian government is installing along the Atlantic and Pacific coasts and the Great Lakes this year. They were bound for the Conference on Safety of Life at Sea, being held in London, England, and from

THE DUPLICATE AUTOMATIC RADIO BEACONS WHICH ARE BEING INSTALLED AT EIGHTEEN LIGHTHOUSE STATIONS IN CANADA, ALONG THE ATLANTIC, GREAT LAKES AND PACIFIC COASTS. THE CENTRAL PANEL IS TO SWITCH FROM ONE TRANSMITTER TO THE OTHER, EACH SET BEING ENTIRELY INDEPENDENT OF THE OTHER, THE DUPLICATE SYSTEM BEING USED IN CASE OF EMERGENCY OR BREAKDOWN

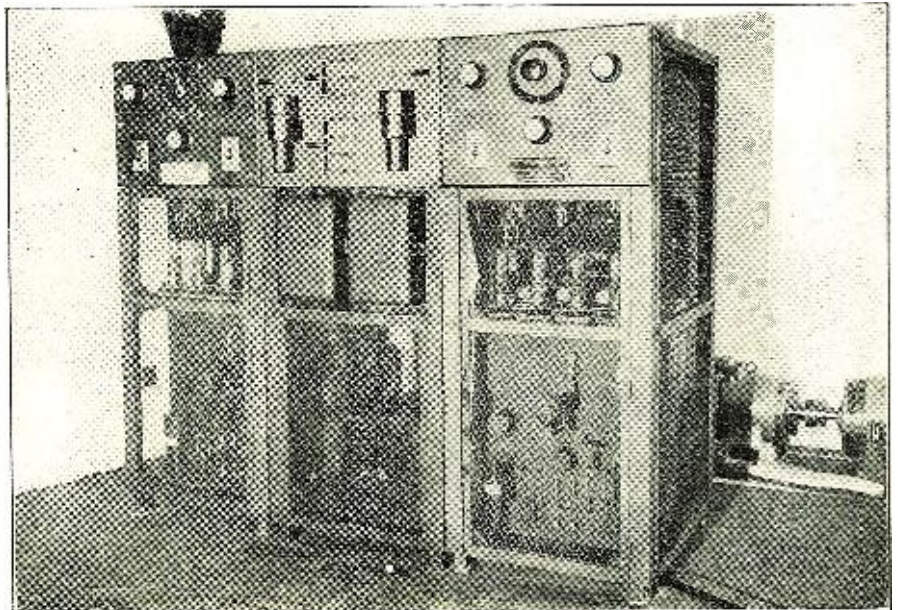

the loud speaker came evidence of the latest device installed by Canada for the safety of shipping off her coasts.

This newest of apparatus consists of a duplicate automatic radio transmitter, emitting a set code signal by which a radio operator can ascertain his whereabouts. Duplicate apparatus is used in case of a breakdown. Then, it is but necessary for the lighthouse keeper to throw a switch, which puts the other set on the air.

Each of the beacons will have a call letter, its code signal. The call will consist of three letters, the first two being VG, denoting a Canadian beacon, and the third will tell which beacon. When a radio operator hears one of these signals he can be sure that he is near some dangerous location. If his ship carries direction-finding apparatus he can locate the position of the ship by the direction in which the signal is the loudest, and can check his exact position by use of a second known radio station's location.

The automatic radio beacons are installed to fill a long felt need. They do away with a special operator, for they are so designed that about the only thing that can go wrong with them is a radio tube burning out. The duplicate set takes care of any other defect, for the lighthouse keeper is warned, by a bell ringing in the apparatus, if anything goes wrong, as well as by the visible means of a small neon lamp which sets on top of the transmitter and blinks the dots and dashes that go forth from the transmitter.

The operation is entirely controlled by a clock. Special electric contacts on the clock close the circuit, for the engine to start as the hands reach the set time. When the engine is properly running, electric contacts on the power panel of the transmitter close and start up the motor-generator which supplies the current for the transmitter; the tubes light up, and within one minute and forty-five seconds from the time that the clock closed contact the signals are on the air. They continue for one minute, just sending out the call, such as VGZ, VGZ, VGZ, for a full minute. Then a two-minute pause follows; the signals go on again; another two-minute pause. Then the carrier note which goes out on the air is shut off, as the second contact on the clock closes the circuit. Once an hour, twenty-four times a day, 365 days in the year, that automatic procedure goes on. Only in fog will the transmitter function continuously, twenty-four hours a day.

Radio operators on all liners and steamers which ply the oceans and lakes will be able to pick up these radio points. The beacons operate on 1000 meters, are powered with four fifty-watt radio tubes, and have a positive range of 75 miles, while their signals have been heard loud enough for direction finding work up to twice that distance. They are operated for the good of all, for the safety of life at sea. There will be seven on the Atlantic coast, from the top of Newfoundland to the mouth of the St. Lawrence River; another six will be placed on the Canadian side of the Great Lakes; and four are arranged for the British Columbia coast. They form another link in the vast chain of stations operated by the Canadian government for the aid of navigation.

EXTRAORDINARY VALUE!
K O L S T E R
Electro Dynamic Reproducer
 Combined with 210 Power Amplifier and "B" Supply Unit



This famous genuine Kolster K-5, AC Electro-Dynamic Reproducer is complete with a 210 Power Amplifier and "B" Supply Unit all self-contained on a steel frame. This real fine matched rugged Unit weighs 45 lbs. without the Cabinet. The Cabinet itself is Pencil-Striped Walnut, beautifully designed with Cathedral grille.

If desired, the 210 Power Amplifier will also supply 22, 67 and 90 volts "B" current, sufficient for any set using up to 8 tubes. An automatic voltage regulator tube, UX-874, maintains the "B" voltage silent and steady.

This Electro-Dynamic Reproducer can be used with any battery or AC set, replacing the last audio stage, or be used with all tubes of the set. Wherever used it will bring out every shading and range of tone; every note is reproduced with utmost faithfulness, pure and undistorted. It will modernize any radio receiver.

Uses 1—UX-210, 2—UX-281 and 1—UX-874 tubes.

A 20-ft. cable is included with each instrument. Operates direct from 50-60 cycle, 110-120 volt AC current.

Brand new in original factory cases and guaranteed. Every Reproducer is serial-numbered and has factory guarantee tag enclosed.

List Price \$175.00
 (without tubes)

Never before \$49.50

AMERICAN SALES CO., 19-21 Warren Street, New York City

"How to Make It"



For the Man Who Likes to Build Things Himself

SO often a little knowledge will do the trick—and here's the book that will tell you how to do it.

"How to Make It" is a veritable treasure-house of information for the man who has the urge to learn to do things for himself. In it you will find full instructions for making over a hundred helpful and unusual things. For example, it includes full details for the grinding of a mirror and the making of a telescope; for building a model tug-boat, a deaf-phone that is of real benefit, a small lathe, a telegraphone, an enlarging machine, and numerous other articles that bring joy to many families.

A copy of "How to Make It" costs only a quarter. Simply clip and mail the coupon below with 25c in stamps or coin to the Experimenter Publications, Inc., 381 Fourth Avenue, New York, N. Y.

Clip and Mail Coupon

ONLY
25c
 COMPLETE

EXPERIMENTER PUBLICATIONS, INC.
 Dept. 2408L, 381 Fourth Avenue, New York

Gentlemen:
 I enclose 25c. for which please send me your book, "How to Make It."

Name.....

Address.....

City.....State.....

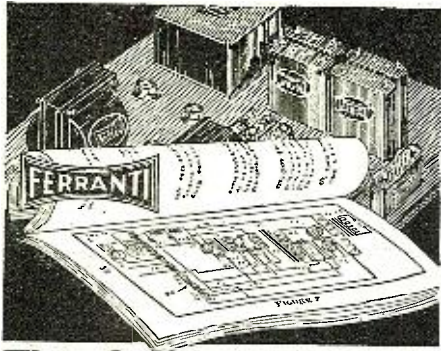

This Great New Book tells you how to build MARVELOUS POWER AMPLIFIERS

HERE'S the latest, greatest and most helpful Book on POWER AMPLIFIERS, Audio Amplification, and Adaptation of Dynamic Speakers. Contains diagrams with components for building 10 hookups, including UX 245 and UX 250 Push Pull Power Amplifiers . . . powerful, realistic amplifiers which will outperform any you ever heard. Endorsed by leading technical writers, professional builders, musicians and others. Send Coupon today.

FERRANTI, Inc.

130 W. 42nd St. Desk 58 New York City

FERRANTI, Inc.,
130 W. 42nd St., Desk 58, New York, N.Y.

Gentlemen: Enclosed find 15¢ coin, for which send me Ferranti POWER AMPLIFIER Instruction Book, post-paid. Money to be refunded if I ask it.

Name.....
Address.....
City..... State.....

ELECTRIFY YOUR RADIO FOR ONLY \$6.85 COMPLETE

Why discard your present good set when you can electrify it for only \$6.85, and banish the annoyance and expense of buying new "B" batteries?



OVER 100,000 TOWNSEND "B" POWER UNITS IN USE
Hooked up in a few minutes. Use same tubes—no changes. You'll be amazed at the improvement in reception and distance getting. Send name and address today for full details, proof and Free Trial Offer.

TOWNSEND LABORATORIES,
725 Townsend St., Chicago, Ill.
Please send me full information on the Townsend "B" Power and Free Trial Offer.

Name.....
Address.....
City..... State.....

ELECTRIC OR BATTERY
3 yr. guarantee
AC-8
\$40.99

Ultra 8
Lighted dial
\$32.29

Radio's most amazing bargain direct from big, old, reliable maker. Don't buy unless 30 days use proves entire outfit unbeatable at 2 to 3 times the price, for tone, selectivity, distance, volume.

Free Catalog and BIG SPECIAL OFFER

MIDWEST RADIO CORPORATION
9th Successful Year
404-UA Miraco Bldg., Cincinnati, O.

TRY IT 30 DAYS FREE BEFORE YOU BUY

Factory to you. Save 50% on latest AC Electric or Battery Radio. Free return privilege.

Big choice of cabinets

BIG DISCOUNT to User Agents

Write for our latest Catalog "B-10," showing big savings in everything for Radio

ALLIED RADIO CORPORATION
711 W. Lake Street Chicago, Ill.

The Use of Electrolytic Condensers in "B" Power Supply Devices

BY R. U. CLARK, 3rd

COMMERCIAL power pack "B" filters in general have changed but very little of late, although a gradual reduction of the size of ordinary types of condensers incorporated therein has taken place in an effort to reduce cost.

Recently electrolytic condensers have become exceedingly popular for use in "B" filter circuits and with the advent of such radically new and low-cost filters as are considered here great impetus has been given to the use of this type of condenser.

In spite of the fact that the filters under consideration are probably the cheapest to produce of most any type offered the public to date the hum level is usually lower than the average and the safety factor greater than many filters which have been offered to date. This is a pretty broad statement, but perusal of the design data submitted here and the oscillograms showing the voltages incurred in the use of such filters will convince the sceptic.

The biggest problem met with by manufacturers in the design of "B" filters is in producing a network that is nearly universal in its application to all radio sets. To do this and still keep production cost down is a very difficult matter. This is due to the fact that various load and by-pass requirements act to completely unbalance the average filter in many cases unless a system is very flexible or can be readily made so, as in the system shown here.

that are wound with dark annealed iron core wire, the main choke being wound with about No. 26 (steel wire gauge) and the voltage divider choke with wire in the neighborhood of No. 30 gauge. This wire is sometimes specified as non-magnetic iron, as it does not retain magnetization as ordinary iron and steel do. These coils can contain about 8,000 to 10,000 turns each and may be mounted in small soft iron cylindrical cans with a

FIG. 2

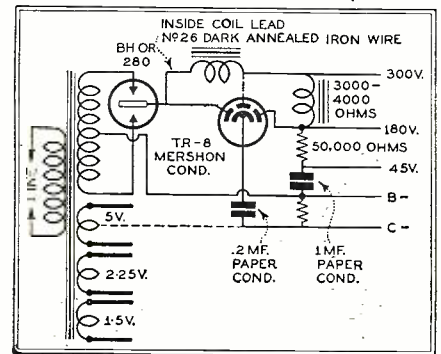

FIG. 1

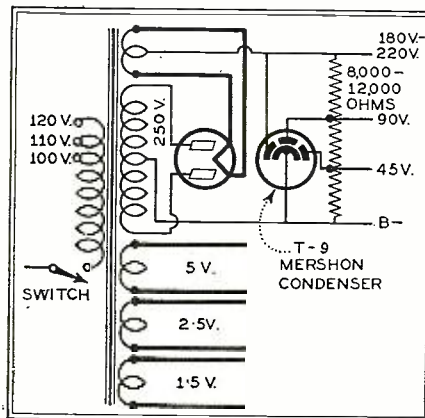

Fig. 1 depicts a basic high-capacity filter consisting simply of a three-section Mershon condenser connected to a resistor of about ten to fifteen thousand ohms to form the voltage divider, this resistor being shunted across the output of the tube. Such a filter is suitable for the 171 and 245 type of power tube where push-pull power tubes are employed.

Fig. 2 shows a high grade type of filter using a triple condenser of 8 mfd. per section in conjunction with choke coils

soft iron bolt as the center core, the diameter of the core being about three-eighths to one-half inch. Coils can be wound by anyone on an ordinary revolving spindle, each layer being separated by waxed paper. The insulation between turns is formed by the iron oxide which is present on the surface of the wire.

The circuit shown in Fig. 2 will supply two "B" voltages of say 300 and 160 at 60 and 30 mls respectively, and used on a six-tube set with a very high-grade audio channel has, in tests, given an a.c. ripple reading of only 1/10 of a volt, which cannot be heard in the ordinary well-made magnetic type of loud speaker.

Working with the fundamental circuit of Fig. 2 it is possible by the addition of small paper condensers at certain points to construct a system which, if properly handled, becomes nearly universal in the sense that the assembly of parts shown may, by minor shifts, be made to work properly in most all cases, changes being readily made without adding materially to the cost or altering the construction.

In explanation of the filter shown in Fig. 3, which supplies 300 volts for power tube plates and grid biasing and 160 to 180 volts for r.f. and a.f. taps and for the detector when plate rectification is used, it might be mentioned that the values of resistors may run about as shown on the appended drawing, and the voltage per side on the high-voltage winding of the transformer used may be about 350 volts r.m.s.

The two last-mentioned filters are exceptionally efficient and can be used with entire satisfaction on the best of sets. Wherever extra "B" voltages are required they can be readily tapped off and by-

passed by small paper condensers, one or more 1/2 mfd. units being added to each tap until complete by-passing is apparent by absence of hissing, squealing or distortion in the loud speaker.

In order to understand why it is possible to use the small chokes specified here, or even eliminate them in some cases, the oscillogram of the filter action of an 18 mfd. Mershon condenser connected directly across the 280 rectifier is shown in Fig. 4. From this it can be seen that the voltage wave form at the rectifier (see lower section of graph) is unusually good—the peak to r.m.s. voltage ratio being only 1.1—1, which accounts for the fact that the peak rating of a good electrolytic condenser need only exceed the working voltage rating by about 20 to 25% or even less if the pack voltage regulation is good.

It will be noted on further examination of the graph shown in the center section of Fig. 4 that the charging current reaches a peak of only 270 Ma., which is one-half of the maximum of the manufacturer's rating allowable on the 280 tube. It is

FIG. 4

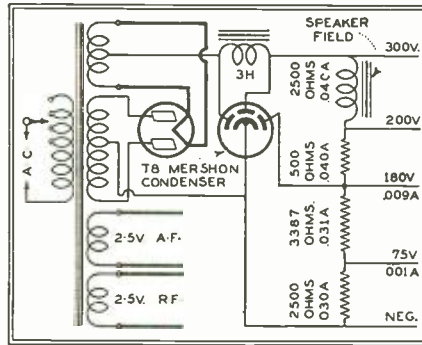
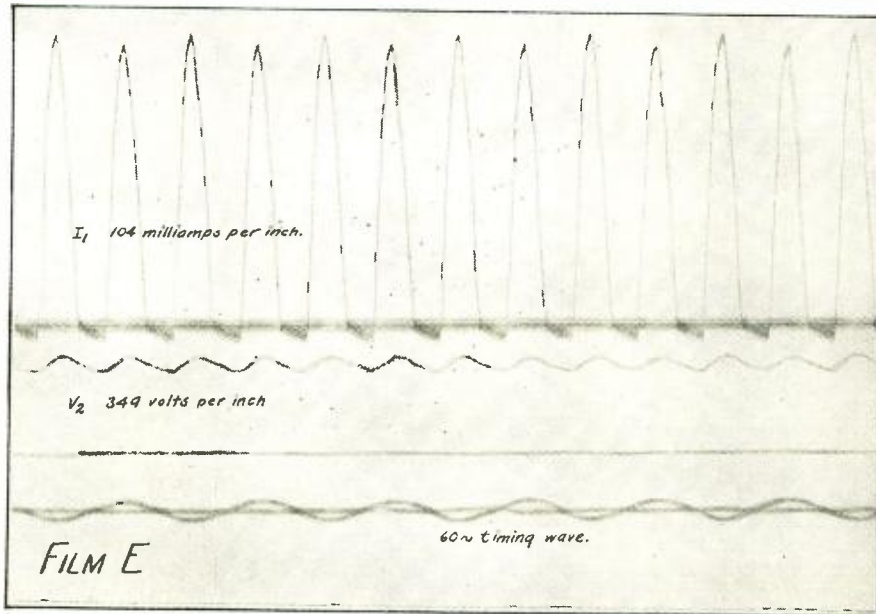

FIG. 3

thus very apparent that the 18 mfd. anode does not overload the rectifier tube under ordinary conditions for packs requiring up to somewhat over 100 mls.

In general it might be mentioned that due to the electrical leakage factor of electrolytic condensers their action at the input to the average filter circuit is considerably better than that obtained by an equal amount of ordinary condenser and causes less loading on the tube to take place.

Learn Electricity by Actual Work

Student Testing and Repairing Motor

In the Great Shops of Coyne

Complete Training in 12 Weeks Get into the BIG PAY FIELD. The whole world of Electricity is open to you as a COYNE-trained man. 12 weeks from now you can be a trained Electrician no matter what you are doing today. Make this the most profitable and enjoyable summer of your life. Come to Chicago on beautiful Lake Michigan, the Electrical Center of the world. I'll allow your Railroad Fare from any place in the United States! Clip Coupon Now for Full particulars and for Big Free Book.

Learn to Earn \$60 a Week and Up Coyne training is practical, money-making training — not correspondence. You work on the greatest outlay of Electrical Machinery in any school in the country, everything from Doorbells to Power Plants—everything to make you a thoroughly-trained BIG-PAY EXPERT.

No Advanced Education or Experience You don't need advanced education and it makes no difference what kind of work you are doing now. I'll make you a trained man through the COYNE LEARN-BY-DOING METHOD! I have done it for thousands—I will do it for you!

Aviation Electricity—Radio—Auto Electricity Courses and Railroad Fare Included—If You Enroll Now

I'll allow your Railroad Fare to Chicago, from any place in the United States if you act quick! And right now I am including absolutely free of extra charge, my complete Aviation Electrical, Radio and Auto, Truck and Tractor Electricity courses. CLIP COUPON NOW!

We Are Specialists We do not attempt to teach you several trades. We specialize in Electricity and nothing else. Have been teaching Electricity by actual work for 30 years.

Earn While You Learn My Employment Department helps you get a job to earn a good part of your expenses and assists you to a good job on graduation.

Send Coupon NOW! Don't delay a minute—get my big Free Book and full particulars of my special offer.

COYNE ELECTRICAL SCHOOL
500 So. Paulina Street Dept. C9-27 Chicago

Mail For Free Book

Mr. H. C. LEWIS, Pres. Dept. C9-27
COYNE ELECTRICAL SCHOOL
500 S. Paulina Street, Chicago, Ill.

Dear H. C.: I sure want one of those Big handsome 12x15 books, with actual Photograph Reproductions. Send it quick. I'll be looking for it in the next mail. I want the facts without placing me under any obligation.

Name.....
Address.....
City..... State.....

Characteristics of Two New Tubes

IN recognition of the tendency to standardize on 2.5 volt a.c. tubes, the Arcurus Radio Company of Newark, N. J., announces two important additions to their line in the development of the type 145 and 124, respectively power and screen-grid tubes.

The power tube has an undistorted power output of 1.7 watts under the following normal operating conditions:

Plate potential	250 volts
Grid bias	—50 volts
Filament voltage	2.5 volts
Filament current	1.5 volts
Amplification constant	3.5
Mutual conductance	1.900 micro-mhos
Plate resistance	1850

The undistorted power output of this new tube is equal to that of the 210 type

of tube and is secured at much lower plate voltages. Also, the low plate impedance improves the tone quality when outputting into readily available load circuits.

The characteristics of the screen-grid tube are as follows:

Heater potential	2.5 volts
Heater current	1.75 amperes
Plate potential	180 volts
Shield-grid potential	75 volts
Control grid bias	1.5 volts
Amplification constant	400
Plate resistance	400,000 ohms
Mutual conductance	1,000 micro-mhos

The 124 tube is of the heater cathode type and is mounted in the UY five-prong base. The control grid is brought out to a cap on the top of the tube.

The Most Interesting Evening I Ever Spent

UP TILL 9 o'clock the party was a complete flop. Nobody seemed to be able to get things going. Then Tom walked in. Tom's a live wire, if there ever was one.

He said he'd heard about a one man show anyone could perform with the help of a book he knew about. He had sent for that book, and said he was going to put on the show.

We thought he was joking and laughed at him, but he sat us all down in the living room, got out a pack of old playing cards, and started to do things that made our eyes pop out of our heads.

For over 2 hours he made those playing cards almost talk. What he could do with those cards just didn't seem human. After it was all over, the gang all crowded around, shaking his hand, and patting him on the back. The girls all said, "Oh, Tom! You're wonderful!" It was by far the most interesting evening I had ever spent.

I asked him how he learned it all, for I knew he didn't know a single thing about card tricks a week before. For answer he pulled out a shiny new quarter, and said that one just like it had taught him every trick he had showed us.

And it was a fact! Tom had simply enclosed a quarter with the coupon below, and gotten Walter Gibson's Famous Book of Popular Card Tricks by return mail. You, too, can entertain yourself and your friends with the 101 card tricks it teaches. No sleight of hand is necessary—no hard work to learn. Simply read the book carefully and you can do every trick in it.

And it costs only 25c! Send for it today. The demand is great, and we only have a few hundred on hand.

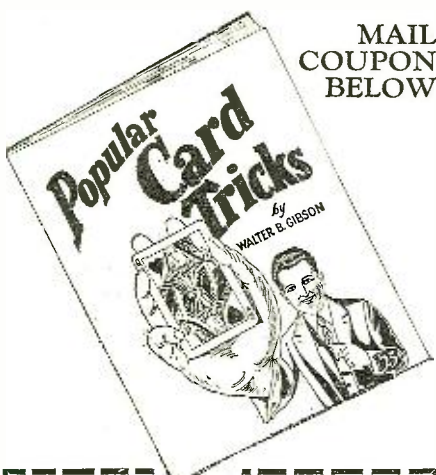

MAIL COUPON BELOW

Experimenter Publications, Inc.
Dept. 2408e, 381 Fourth Ave., New York, N. Y.

I enclose 25c. (in stamps or coin) in full payment for Walter Gibson's Book of Popular Card Tricks, which, it is understood, will be sent me by return mail.

Name.....

Street & No.....

City.....State.....

Which Power Tube Shall I Use?

(Continued from page 149)

in push-pull rises to only 10 per cent when supplying six watts. The push-pull arrangement gives less harmonic output at all power levels, but at outputs below approximately 0.7 watts the harmonic output from the single tube is five per cent or less, an amount of harmonic distortion which is not appreciable to the ear. Therefore if the single tube is always operated below about 0.7 watts we can get essentially distortionless output from the tube.

Overloading and Distortion

It is a fact, however, that tubes—especially power tubes—are frequently overloaded in practice. As a result when single tubes are used in power amplifiers it is essential that they have a power rating sufficiently high so as to prevent any possibility of overloading. However, if we use the push-pull arrangement the normal rating of the tubes may more nearly coincide with the value we feel is required for good reproduction because push-pull tubes do not produce serious distortion even when called upon to supply amounts of power much in excess of the normal rating of the tubes. It certainly is of advantage to be able to use a circuit in which the distortion will not be especially serious in case the tubes are accidentally overloaded, and this fact probably accounts in a large measure for the wide popularity of the push-pull circuit. Those who have been following the design of manufactured receivers have probably noted that many sets are gradually coming to the use of push-pull amplification, thereby following a trend in design started some two years ago by the home experimenter.

Because the home experimenter is always anxious to construct a power amplifier giving the best possible reproduction, the preceding figures on push-pull, in the writer's estimation, make it generally advisable to use push-pull amplification. More specifically, the writer feels that Table II given in the preceding part of this article can be even further compressed as follows: For power outputs below 0.5 watts, use a single 171A; for power outputs from 0.5 to about 2 watts, use 171A's in push-pull and for outputs from 2 to 5 watts, use 245 tubes in push-pull. These it should be realized are simply the conclusions the writer reaches from the preceding discussion, and it is quite possible—probable, in fact—that some experimenters will feel differently about the matter. Even so, our discussion, we feel, is a step in the right direction and has, we hope, helped to make the whole subject somewhat clearer.

The New "245" Power Tube

At various points in this article we have referred to the type 245 tube which is the newest of the power tubes to be made available to the home constructor. Because this tube is so new it will be worth while to give some data referring particularly to it.

First, let us get down in table form the complete characteristics of the type

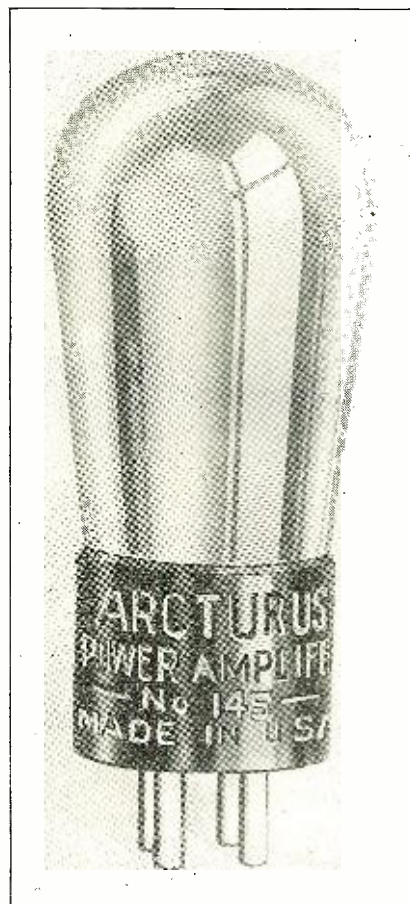

IN RESPECT TO THE PHYSICAL DIMENSIONS OF THE 245 TUBE, IT IS SOMEWHAT LARGER THAN THE ORDINARY 201A TUBE

245 tube. These characteristics are given in Table IV. Let us look over the table together. In the first place we notice that the type 245 tube is designed for operation on 2.5 volts a.c. and that the filament requires 1.5 amperes. This is the first interesting point, for the 245 tube is our first power tube designed with the requirement of a.c. operation in mind, with a low voltage, high current filament—the filament voltage actually being the same as that required for the type 227 tube. Therefore the 245 tube should have its filament supplied from a 2.5 volt winding on a power transformer.

The next items in the table are the plate voltage and the plate current. We notice that the maximum permissible plate voltage is 250 volts, which puts the tube in the class of medium voltage tubes such as the 171A, although the maximum voltage which can be applied to the 171A is 180 volts. The plate current of the 245 tube is 26 and 32 milliamperes at 180 and 250 volts respectively. And, these currents are somewhat greater than the plate current of the 171A tube, which is 20 milliamperes at 180 volts. The fifth column gives the value of the negative C bias voltage which is required on the grid of the tube to give normal operation. The amplification factor (column 6), is 3.5, which is slightly greater than the mu of the 171A, which is approximately 3. The plate resistance (column 7), is 2,000

ohms—the same as the 171A. It is in the power output of the type 245 tube that we find the important difference between it and other types of tubes. Let us compare the power output of the 245 with other types of power tubes. See Table V.

The tabulation shows clearly the advantage of the 245 for at 250 volts on the plate it can deliver 1.6 watts of power whereas the 210 will supply at this voltage only .35 watts and the 250 will supply .9 watts. The 245 at 250 volts will supply more power than the 210 at 400 volts!

In summarizing the characteristics of the 245 we can therefore say that it is a tube designed to supply fairly large amounts of power at medium plate voltages. We are thus able to obtain comparatively large amounts of audio power from a power supply of reasonable cost, for here low voltage power transformers and low voltage filter condensers can be used.

Regarding circuits for the 245 tube we show in Fig. 2 the circuit of a two-stage power amplifier for the type 245 tube in push-pull. Fig. 3 shows a single power audio stage employing one 245 tube. Note that when using a single 245 tube none of the circuit constants need be changed except the 800 ohm bias

resistor for the power tubes. When only a single 245 is used this resistor should have a value of 1,600 ohms. In building an amplifier with either one or two 245's no special precautions need be followed except those ordinarily adhered to in the construction of a.c. operated amplifiers. The filament leads to the various tubes should of course be twisted. The 6 ohm resistance across the 227 heater and the 10 ohm resistor across the 245 filaments should be located as close as possible to their respective tube sockets. If the single 245 circuit is built it is preferable to use a choke-condenser output with one side of the loud speaker connected to the condenser and the other side of the loud speaker connected to the center tap of the 10 ohm resistor across the 245 filament. Under no conditions should the loud speaker be returned to B— for the a.c. currents will then have to flow through the 1,600 ohm (800 ohm in the push-pull circuit) C bias resistor and the common coupling thereby produced will ruin the quality of the amplifier. Also in the single power tube circuit it is advisable although not essential to connect a 1 or 2 mfd condenser across the C bias resistor for the power tube. This resistor is indicated in dotted lines in Fig. 2.



Notes on the R. M. A. Chicago Show

AN inspection of the million-dollar exhibit of radio receivers, loud speakers, tubes and apparatus displayed at the Fifth Annual Convention of the Radio Manufacturers Association, indicated beyond all doubt that the industry has made magnificent strides since the last convention and trade show a year ago.

New inventions, improvements and refinements are of such an outstanding nature that a new era in home reception is presaged for radio fans.

Among the companies exhibiting radio receivers for the first time were: Associated Radio Manufacturers, Inc.; Balkeitt Radio Company; Gulbransen Piano Company; Silver-Marshall, Inc.; Story & Clark Piano Co.; Temple Corporation; Victor Talking Machine Division of Radio-Victor Corp. of America; United Reproducers Corporation. The latter company is also introducing a new condenser type speaker, the Kyletron, named after the inventor, Colin Kyle.

A canvass of manufacturers revealed the fact that the radio buying public is to receive a greater amount of radio, per dollar expended, than ever before in the history of the industry. In the opinion of one executive, the radio buying dollar is nearly approaching the value of the dollar spent for automobiles.

Every indication points to large use of the new screen-grid tube. Many manufacturers have included a model or models which make use of it. Some manufacturers have "gone all the way" and are making only screen-grid sets.

Dynamic speakers, which were introduced on a large scale last year, are more

popular than ever. They, too, like receivers, are further refined and made more rugged, so as to take care of the increased power which characterizes all new sets. Most of the new dynamics being employed are of larger diameter than heretofore, with a range up to 14 inches on some of the more expensive jobs.

Selector tuning, or employing a device which automatically tunes the set to one of a number of predetermined stations, is found on a number of receivers. Remote control, by which the radio receiver may be tuned in any room of the house, makes its appearance on one model. Other manufacturers are bringing out remote control devices.

Manufacturers are one in saying that better selectivity, sensitivity, design of both cabinets and chassis, better reproduction and simplification of installation and operation are notable refinements. The variable is the way in which these refinements and improvements are emphasized by the particular manufacturer.

There is a definite trend to console models, and the cabinet manufacturers have made notable contributions to the "dress" of receiving sets. Authentic period designs of most pleasing detail are now, for the first time, usual practice. Both highboys and lowboys, as well as open-faced jobs, are offered in a choice of walnut, mahogany, oak, oriental walnut and other fancy woods. Doors are of the sliding variety or the French type. All in all, design, construction and finish are far superior to that of years previous—undoubtedly the result of feminine appreciation for fine furniture in radio sets.

Jensen Patents allowed and pending. Licensed under Lektophone Patents

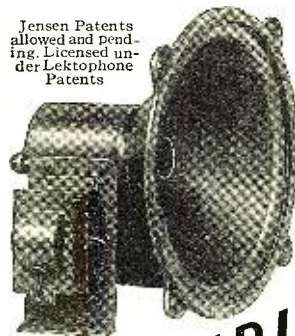

ANSWERING
the demand
of an **INDUSTRY**
the new
Jensen
CONCERT DYNAMIC

Peter L. Jensen has applied entirely new and original principles in the design of this new dynamic. The cone is 10 inches in diameter. The moving coil represents an innovation in design. The sensitivity is greater than that ever attained in any previous dynamic speaker, and the ability to reproduce enormous volume is exceeded only by the Jensen Auditorium Dynamic.

The Concert Dynamic definitely sets a new standard of excellence. For along with the musical reproduction of bass notes as low as 30 cycles, the higher frequencies are reproduced with extraordinary brilliance. In fact the entire musical scale is reproduced with a brilliance and firmness of quality never acquired before.

There is no need of a "side by side" comparison to appreciate the superiority of this new speaker. Wherever it is heard its performance is both startling and impressive.

Write for complete information and ask for a frequency response curve of this new speaker if you are interested. Ask also about the new Jensen Imperial, a beautiful cabinet equipped with either the Concert or Auditorium Unit.

NEW LOW PRICES

JENSEN CONCERT DYNAMIC
with 10 inch cone
D7AC, \$35.00 D7DC, \$27.50

JENSEN AUDITORIUM DYNAMIC
with 12 inch cone
DA5AC, \$70.00 DA5, \$55.00 DA4, \$55.00

JENSEN PATENTS ALLOWED AND PENDING
LICENSED UNDER LEKTOPHONE PATENTS

JENSEN RADIO MFG. Co.
6601 S. Laramie Ave., Chicago, Ill.
212 Ninth St., Oakland, Calif.

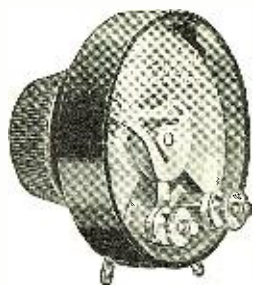

A Radio Receiver Is Like a Chain

A chain of parts, if you please . . . transformers, tubes, condensers, resistances and the like as links of the chain. Unless each link performs to perfection, the whole receiver is condemned.

A lot of grief can be traced to one little part . . . the volume control. Noises are set up . . . unevenness of control develops . . . locals are hard to handle.

You can save yourself plenty of trouble by seeing that the name "Centralab" is stamped on the volume control.

Central Radio Laboratories
20 Keefe Ave. Milwaukee, Wis.



NEW! A. C. Line Voltage Control

For Radio Set Manufacturers

A remarkably convenient and efficient device which automatically handles A. C. line fluctuation over a broad range.

Cost surprisingly low.

For Details, Write Dept. RN8

Radiall Company
50 FRANKLIN ST., NEW YORK

Makers of the **AMPERITE**
The "SELF-ADJUSTING" . . .

Good Buys in "B" Battery Power

100-Volt Edison Element, Non-Dischargeable Rechargeable "B" Battery with charger. Shipped dry, with solution, \$12. 140-Volt with charger, \$17. 180-Volt Power Unit, with Trickle Charger, \$24. SEND NO MONEY—PAY EXPRESSMAN. Write for our Free Literature

SEE JAY BATTERY CO
915 BROOK AVE NEW YORK

The Serviceman

(Continued from page 156)

Some Causes of Trouble in Sets

Mr. J. E. Smith, President of the National Radio Institute, has prepared a rather lengthy manuscript on the practical servicing of radio receivers. Much valuable information for the serviceman is contained therein and from month to month, portions of Mr. Smith's material will be presented in this department. An excerpt from Mr. Smith's article follows. (Technical Editor.)

* * *

THE problem of properly servicing radio receivers has many times been discussed from A to Z, also much has been written concerning the troubles likely to occur in a radio receiver. Many daily papers and magazines devote space to the answering of service problems for the radio fan. However, this type of information usually refers to specific conditions, and while it is ideal for the individual asking the question very seldom is it of any particular value to the majority of people.

This data is written to cover mainly the fundamental faults likely to be found in a receiver. All receivers, when they refuse to function, regardless of what type they may be, fail because of some fundamental reason. When the serviceman learns the fundamental things that are likely to go wrong in a receiver it will be comparatively easy for him to service any type of receiver. Of course, the more experience a man acquires, the more adept he will become in locating the trouble in a defective receiver. Any spare time that a serviceman might have can always be profitably employed by studying the various receivers available to him, paying particular attention to such things as are peculiar in each receiver so as to become better acquainted with the different manufacturers' sets and how they may be serviced.

Receivers now being manufactured are generally either of the tuned radio frequency type or of the superheterodyne type. Very few straight regenerative, untuned radio frequency or crystal receivers are now being built for broadcast reception. However, the servicing of the last named type is not difficult and very little experience is required to correct any defect that might be found in one.

The servicing of superheterodynes or tuned radio-frequency receivers presents a much more difficult problem. Because of the complicated circuits involved a systematic routine must be adopted in order to cover the servicing of either of these receivers.

A receiving set consists essentially of a pick-up circuit, a detector circuit and an audio frequency amplifying circuit. The pick-up circuit usually consisting of a radio-frequency amplifier. When a multi-stage r.f. amplifier is employed some method of suppressing the tendency of the tubes to oscillate when tuned to resonance must be employed. This may take the form of a neutralized circuit or in many receivers it is simply a coil of resistance wire so placed in the circuit that

the losses will be high enough to prevent any tendency to oscillate that the tubes might inherently possess.

The detector circuit may employ either a tube or crystal. In the audio frequency amplifier one, two or three tubes are generally used. These may be coupled to one another by means of resistors, impedances or transformers, the latter being more commonly used because of simplicity and the higher amplification available when using this type of coupling. In all modern receivers the last a.f. stage employs a power tube in order to realize sufficient volume with good quality. Oftentimes the last a.f. stage has more than one tube. This is the case in a push-pull amplifier. Such an arrangement is capable of delivering a much greater undistorted signal than when only one tube is used.

Any set on the market may be classified under one of the foregoing classes. In much the same way that receivers may be grouped under circuit classifications their failure to operate properly may be grouped under certain general classes.

With the proper equipment in charge of a competent man the servicing of radio receiving sets can be made fairly simple. To service a radio set does not require that one be a radio engineer. It does, however, require that one know the function of the various component parts and be able to determine whether or not they are functioning properly in the circuit. As experience is gained and the serviceman becomes more and more proficient in his work the trouble in most receivers will probably be apparent after only a few minutes of testing. However, it is always a good plan to thoroughly inspect each and every part to insure that nothing else is on the verge of a breakdown. This oftentimes will save another service trip in the near future.

Fundamental Faults and Their Correction

The importance of learning the fundamental laws of electricity cannot be stressed too much. Take for example our engineering colleges and universities of today. For three years the student of engineering is taught physics, chemistry and mathematics. Other studies are introduced mainly to give the student an idea of how the fundamental subjects are applied into practice. After a student has thoroughly mastered the laws of mathematics, physics and chemistry he is then able to work an engineering problem with little difficulty. However, had the student not mastered the fundamental subjects required he would be utterly lost when a difficult engineering problem was encountered.

Radio, like all other branches of engineering, is built around a few fundamental principles. Since a receiver is built around a few fundamental principles it is obvious that its failure to operate properly would be due to some fundamental fault.

(Continued on page 181)

(Continued from page 180)

These faults may be grouped under the following headings, namely:

- Lack of operating experience.
- Location and weather conditions.
- Defective accessories.
- Open circuit.
- Short circuit.
- High resistance connection.

Lack of operating experience may be the result of not following out the manufacturer's instructions carefully enough, or perhaps the instructions do not go into detail or are too complicated for the novice to comprehend. It is always a good plan to read over the instructions received with the set before it is put into operation. Even though the customer has had considerable experience with receiving sets the service man doing the installation should go into detail on how to operate the set properly and just what to expect from it. Also give the customer a chance to ask any questions that he is in doubt about. Many times the questions that are asked by the average person are preposterous, but nevertheless try and give each one your full attention. Also do not fail to tell the customer the probable length of the life of his tubes and his batteries if the set is battery operated.

Many times the owner of a new radio is very impatient to have it operating and in his haste has not carefully carried out the instructions faithfully. Instruction sheets were written to enable the customer to get the most out of his set, so therefore should be followed to the letter. It is peculiar but nevertheless true that the first night a receiver is installed, the customer feels that he should receive several distant stations even though he lives in a congested metropolitan district where several local stations are operating. This is not always possible. Many factors contribute to good reception. For instance, the location and weather conditions play an important part in the functioning of a radio receiver. In one location a set may be very satisfactory while in another location perhaps only a block or so away the set will be nearly "dead" to anything except local programs. The performance varies also in accordance with the weather conditions. The best results usually being obtained on a rather cool moonlight evening.

The type of building in which the receiver is located as well as the proximity to steel frame structures, power lines, street railway systems and the topographical surroundings are important items to consider when the range of the receiver is being questioned. In the vicinity of large steel structures the signal strength is usually somewhat decreased. It has been the experience of ship operators to have their signals fade nearly to inaudibility when passing beneath large steel bridges. Many times a steel building will have a shielding effect on the signals so that it is impossible to receive certain stations in one location while in another location close by the signal strength will be of normal intensity.

The best method of determining

whether or not the location is poor is to try the set in a location which is known to be good and compare the results. Of course the comparison should be made in the same evening, otherwise the difference in weather conditions might be great enough to counterbalance the difference in range between the two locations.

Topographical and geographical locations affect the range to a considerable extent. For instance, if you are located at the foot of a range of mountains you must not expect the same results as someone located on a plain or by the seashore. The mountains would no doubt shield the signals coming from their direction, while if you were located on a plain there would be nothing to absorb the feeble electromagnetic waves before they reached your antenna. Along the seacoast the average reception will run somewhat better than a location 50 or 100 miles inland. However, along the seacoast there is an abundance of dampness, and when this penetrates into the receiver, especially the transformers, it is sometimes necessary to replace them or bake them to drive out all of the moisture they have absorbed. The insulation on some cheap receivers will also be found to have collected moisture causing high-frequency losses to such an extent that the sensitivity will be practically nil. When installing a set near the seacoast or when the humidity is very high make sure that the insulation materials used are composed of first class material and that all parts likely to absorb moisture are impregnated with some moisture-proof compound.

Under the defective accessories we list defective tubes, batteries, power units, speakers, antenna and ground systems and the improper installation of same.

Defective tubes may make a receiver appear to be "dead." The filaments may all light to their normal brilliancy, but the emission may be so low that nothing is heard. Then again even though the volume has not decreased any considerable amount the signal may be so distorted as to be absolutely unintelligible. Defective batteries and power units will act in much the same way as defective tubes. Many times the quality is not as good as would normally be expected because of a defective speaker or due to the output of the receiver not being properly matched to the speaker. Dirt, dust or some foreign material may have collected around the armature, preventing it from operating properly or causing it to rattle badly.

It is possible that the antenna and ground system have been improperly installed or that the connections have not been carefully soldered and through corrosion a high resistance connection is made, thus decreasing the set's efficiency.

Of all of the accessories the tubes are the most likely to cause trouble because of their extremely delicate construction.

Open circuits may cause a set to be entirely inoperative or partially dead according to the nature of the break. All movable connections in a set should be

(Continued on page 182)



MODEL NO. 102—A massive walnut cabinet equipped with automatic phonograph and an improved radio receiver.

Steinite
ELECTRIC-RADIO

Only Durhams are good enough for this Great Receiver!

ANY manufacturer can cut his parts costs, but it takes leadership to aim at quality reception as a means of winning a quality market, such as Steinite has done in a few short years. Steinite operates on the principle that you can get out of radio only what you put into it. And so Steinite means a quality circuit embracing every practical modern idea, not the least of which is DURHAM Resistors and Powerohms—the metallized resistances which are endorsed and used by leaders in every division of the industry. Durhams may cost a trifle more than average resistances, but experience has proved that their slight additional cost is cheap insurance against imperfect performance and against dissatisfied purchasers. Ask Steinite!

We shall be glad to send engineering data sheets and samples for testing upon request. Please state ratings in which you are interested.



DURHAM Metallized RESISTORS and POWEROHMS are available for every practical resistance purpose in radio and television circuits, 500 to 200,000 ohms in power types; 1 to 100 Megohms in resistor types; ratings for all limited power requirements; standard, pigtail or special tips.

THE LEADERS STANDARDIZE ON

DURHAM
METALLIZED
RESISTORS & POWEROHMS

INTERNATIONAL RESISTANCE CO.
2006 Chestnut Street, Philadelphia, Pa.

Short - Wave Manual

Prepared by Eminent Short-Wave Experts

Edited by H. M. BAYER

Up-to-the-Minute Data—All Worth-While Circuits

50c

THE COPY

FULL SIZE BLUEPRINTS BOUND IN BOOK

As practically every one today knows, some of the finest programs are being broadcast over the short-wave bands. There are many reasons for this. Paramount among them all is the fact that that entertainment, broadcast in this band, can be received over distances which with the ordinary broadcast receiver would be impossible! Thousands of letters, which pour in an unremitting stream into our offices tell the same tale—it is a common and everyday matter to receive programs from all foreign countries, from the most distant climes. England, France, Germany, towns on the African continent, from every conceivable corner of the globe where a station is located—programs come in with surprising volume and clarity. One would think they were hearing a New York, Chicago or San Francisco station until the voice of the announcer, many thousands of miles away, discloses the true location of station. In the **SHORT-WAVE MANUAL** you will find complete diagrams, full size blueprints pasted into the book. These tell plainly how to construct all these short-wave circuits, which our tireless laboratory researches have shown to be most efficient. The **SHORT-WAVE MANUAL** contains complete information on everything concerning Short-Wave reception. Large size book (same size as Radio News) with a beautiful colored cover. Replete with illustrations, diagrams and with **FULL SIZE BLUEPRINTS**. This big valuable book will show you how to receive all the foreign countries clearly and easily. Write today for your copy.

EXPERIMENTER PUBLICATIONS, Inc.

381 Fourth Avenue New York

Mail This Coupon

RN-S

EXPERIMENTER PUBLICATIONS, Inc.
381 Fourth Avenue, New York

Gentlemen:

Enclosed find 50c for which please send me a copy of THE SHORT-WAVE MANUAL.

Name

Address

City..... State.....

(Continued from page 181)

checked when searching for an open circuit. A burnt-out transformer or a mechanical failure of most any component part is often the cause of an open circuit.

Short circuits, like open circuits, are generally caused by a mechanical failure in some of the component parts. Tubes may also be the cause of short circuits. This is brought about by some heavy jar or vibration breaking the delicate filament and making it fall in such a way as to short between the elements of the tube. Many times such a short is not as serious as would be expected since when the power supply is shorted the voltage applied through the short is usually enough to burn out the tiny wire making the short. This is not always the case though, so it is possible that an internal short in a tube may be more disastrous than contemplated, possibly burning out a transformer.

A broken down by-pass condenser can cause considerable trouble and oftentimes when the breakdown is of a temporary nature, that is intermittently breaking down and healing, it is very difficult to locate. However, by-pass condensers which break down and heal intermittently are rarely found.

The foregoing troubles as experienced in servicing are relatively easy to check upon especially when the proper testing apparatus is available. With regard to the next item in the list of fundamental faults we find a more difficult type of failure to locate. It is possible to have high resistance connections in any part of the receiver. They may take the form of a poorly soldered joint where a corrosive flux has been used and not properly cleaned, a weak contact on a switch or other piece of apparatus, an accumulation of dust or dirt between condenser plates, leaky condensers, etc.

The fundamental faults described above represent in a general way the cause of unsatisfactory operation experienced with radio receivers.

Reactivating Tungar Tubes

"Often the serviceman is called upon to put in working order other radio apparatus besides receivers. My experience with reconditioning a tungar charger may be of interest to other servicemen." This is what Mr. A. K. McLaren, of St. Joseph, Mo., says. His suggestion follows:

"Tungar tubes may be easily made as good as new when they are only suffering from scale which forms on the graphite button. While the battery chargers are being replaced by all-electric sets, there are yet thousands using batteries and the tungar chargers, to whom this may be of help.

"The small trickle charger tubes seem to suffer from this trouble most, the larger tubes either burning out or the filament sags away from the anode, making the tube useless. The smaller tubes do not seem to pass enough current to keep the graphite in a working condition, a sort of scale forming which insulates the button and causes the tube to become inoperative.

"To remove this scale, procure a spark coil such as a Ford spark coil and connect one of the high-tension terminals to the filament of the tube and the other high-tension terminal to the anode or graphite button. The high-tension terminals of a Ford coil are the two on the side of the box. The primary terminals are the bottom one on the side and the one on the bottom of the box.

"Connect the primary terminals to a six-volt battery and a spark will pass between the filament and the graphite button. The spark punctures the scale and removes it. This treatment should be continued intermittently for a couple of minutes and then if the tube does not function normally it should be repeated. When the tube is working properly a blue glow will be seen around the filament. With the large tubes, in charging a six-volt battery, if they fail to start when first turned on, they may sometimes be started by short-circuiting the charging terminals for an instant."

The Serviceman's Tools

Practically in every trade there is need for specially developed tools with which the workman plies his trade. The auto mechanic, if he is a good one, will see to it that he is completely outfitted with the various sizes of wrenches, screwdrivers and other implements which are necessary to his satisfactorily carrying on the work he has chosen to do. The blacksmith has his huge hammers and anvil, his forge and tongs; at the other extreme, the jeweler and watch repairer has his delicate lathes, screwdrivers, tweezers, etc. And so it is—every man to his trade and every trade with its specialized tools.

Radio, especially radio repairing, is no exception to the rule and it, too, has a set of tools which help to make the work of repairing easier; which help to expedite the making of repairs and thus cut down the amount of time taken to do a satisfactory job.

Radio tools may roughly be divided into two general classes; first, those which the repairman uses to actually locate the trouble, and second, those which he employs to actually do the repair work once the faulty parts are determined. If the serviceman is inclined to be quite fastidious and spend a great deal of money on an expensive outlay of tools of both classes there is no end to which he may go in thus outfitting his repair shop. He can go so far as to actually go beyond the repair sphere and border on the advanced high-powered laboratory by the purchase of costly bridges, tone oscillators, both fixed and variable, vacuum tube voltmeters and the best there is to be found in meters.

For the ordinary serviceman who wants to do a good job so that his customers will be satisfied, there are some tools which are an absolute necessity. Some of them fall in the first class, the trouble-finding tools, and others in the second or actual repair class.

Under the first classification comes a

(Continued on page 183)

(Continued from page 182)

good voltmeter of the d.c. variety having a scale of at least 250 volts full scale and possibly 500, if a more costly one is within his means. This meter should be of the "high resistance" type so that satisfactory reading of the output of "B" power supply devices can be made without taking too much current and thus jeopardizing the accuracy of the reading. Usually these meters are so constructed as to have a two or three range scale so that lower voltages can be more accurately read. Another or second meter which the serviceman should have is a milliammeter having a full scale range of at least 50 mils. Such an instrument is useful in checking the current drain of tubes in a receiver under actual working conditions so that their proper functioning may be ascertained. For power supply units boasting of two 210's, two 245's or two 250 tubes a larger scale reading meter must be employed or a carefully adjusted shunt used across the terminals of the meter to halve or quarter the reading obtained.

One of the most useful of instruments which falls into this category is the tube and set tester described in this magazine last month by M. K. Barber, who is a serviceman in two senses. Mr. Barber services the radio receivers of his friends and acquaintances and speeds his work along with surer chances of success by means of his set tester than if it were not employed. Mr. Barber is also a serviceman in that he is a master sergeant connected with the garrison at Fort Ethan Allen, Vermont.

Into the second classification falls such tools as soldering iron, brace and bits, hand drill and assortment of drills from 0 to 60, long, narrow-bladed screwdrivers, center-punch, light hammer, cutting pliers of the side-cutting variety, cutters fitted with grip jaws, long-nosed pliers, duck-billed pliers, spintite wrenches, scribe and scale, small portable vise, and a good, durable knife. Naturally with the soldering iron go a good grade of soft strip solder and some cleansing agency or flux. Friction tape is an essential that should be in the tool kit of every serviceman who goes by that name. Wire of various kinds is also indispensable. Braidite wire is well insulated, comes in either flexible

or solid form and is easy to use and solder. Also, with the growing use of all-electric receivers, it is not such a bad idea to pack a few sizes of screw and cartridge fuses in the tool kit.

The general essentials are listed here. Undoubtedly others will suggest themselves to the serviceman or perhaps he wishes to be more complete in his tool complement and will go just a bit farther than just having these essentials. Whatever the case, though, remember, half the battle is won by being prepared to meet any and all contingencies and the estimation that people whom you serve will have of you will be formed more or less by the manner in which you tackle a repair problem of theirs. If you go to them just guessing at the trouble which ails their receiver probably that will be the last call you will ever make at their or their friends' homes. On the other hand, if you go to them fully prepared to sensibly determine what ails their "super-bloopodyne" by subjecting it to a rigid, fine-comb inspection and test and accomplish it with dispatch and accuracy by means of the proper kinds of tools you may rest assured that if a future occasion for repair arises you will hear from them again. The continued growth of the radio industry depends largely upon the state of mind of the buying public and the aid which they look for and receive at the hands of the serviceman, the fellow who takes up where the radio store salesman leaves off.

In any industry having a phenomenal growth, such as the radio industry, there are bound to spring up companies and persons masquerading under the name of servicemen and laboring under the false impression that it's well for them to get the money while the getting is good. Too many of this gentry have left a bad taste in the mouths of those unfortunate enough to require their services (?) and the serious-minded serviceman who wants to deliver a good job is the one who suffers. One of the ways he can overcome any possible unfriendly feeling which might be held by set-owners against all servicemen in general is to equip himself so as to do a good job at a minimum of time and expense commensurate with satisfactory results. A word to the wise is sufficient.

AREDUCTION in the number of cleared channels now set aside for exclusive use by high-powered stations has been proposed to the Federal Radio Commission by Commissioner Sykes and will probably be given consideration prior to the opening of the winter broadcasting season next fall.

The commissioner has proposed a reduction from 40 to 35 in the number of cleared channels, by assigning seven, instead of eight, exclusive frequencies to each of the five radio zones. On the five channels so obtained, it is proposed to put ten stations, two on each channel, for simultaneous night operation, the stations on each channel to be widely separated in distance.

It is contended by Commissioner Sykes that high-power stations on cleared channels in the far west are not heard along the Atlantic Coast, and vice versa, and that a reduction in the number of cleared channels would afford opportunity to give high-class service to greater extent than

is now possible. By limiting the power of the stations on the proposed semi-exclusive channels, heterodyning could be avoided over practically their entire range of service.

Under the reallocation order effective last November a total of 74 channels were made available for what was expected to be "high-grade reception," 34 channels being assigned for regional service and 40 for exclusive use by high-power stations. On these 40 channels only one station was to be permitted to operate at any time during the night hours, thus insuring clear reception of the station's program up to the extreme limit of its service range, these channels being divided equally among the five zones. Under a recent court decision, however, WGY in Schenectady and KGO in Oakland were held entitled to operate simultaneously on the same channel, exclusive use of which after sunset had been granted the western broadcaster. — *Washington Radio News Service.*

Short Wave 4

As described in RADIO NEWS

EXTRA EXTRA

Radio and Aeronautics — advancing hand in hand. The Columbia Broadcasting system uses the Short Wave 4 exclusively to follow the Graf Zeppelin on its 2nd flight across the Atlantic.

You—who are interested in Short Waves! 1. The Short Wave 4 was endorsed by "The Sun" and allowed a three page article.

2. It actually gets 5 S.W. London on the loud speaker.
3. England, Germany, Holland guaranteed.
4. It can be assembled in 3 hours.
5. It employs only the best of apparatus.
6. It is completely shielded, etc., etc.

Besides:

The more you study this receiver the more you want it. Because it is not just another Short Wave Set but it's
A Short Wave Wonder of Wonders.

COMPLETE SET OF PARTS, Ready to assemble \$62.50

FOUNDATION UNIT can be had separately for..... \$29.50

Order on this Coupon

WIRELESS EGERT ENGINEERING, INC.
179 Greenwich St., New York.

Enclosed please find money order for which you will kindly send at once (check one desired)
Complete set of Parts\$62.50
Foundation Unit only 29.50
Thank you very much.

Name

St. & No.

City and State

Do You Want to Break Records?

Contrary to public opinion, it is possible to work greater distances today than ever before, particularly on short waves. BUT— with the usual broadcast receiver, made primarily for powerful signals, DX is not feasible. With the usual short-wave receiver, combined with average amateur skill, super-reception is difficult to attain.

Would you like to tune in Java, India, Siberia, Holland, England and Germany in one evening, via short waves? Would you like to tune in stations from coast to coast, the Mexican stations, Canadian stations, and certain European stations on broadcast wave lengths?

It's just a question of precise details. Thus the GRID LEAK CLAROSTAT will provide precise detector action. The VOLUME CONTROL CLAROSTAT will provide razor-sharp regeneration. The HUM-DINGER will provide correct grid bias for screen grid tubes. And so on. The story is too long to be told here. so—

WRITE for Clarostat literature on how to improve your radio set no matter what it may be. Better still, send 25c in stamps or coin for "The Gateway to Better Radio"—32 pages, 88 illustrations, and over 20,000 words of practical radio data.

CLAROSTAT MFG. CO., Inc.
Specialists in Radio Aids
281 N. 6th Street Brooklyn, N. Y.

Become An Expert At Bridge

*This New Picture
Method Book by
W. C. Whitehead
Will Quickly
Teach You*

IN his new instruction book Wilbur C. Whitehead, famous teacher of Bridge, shows you a new short-cut method to the complete mastery of that fascinating game.

By using hundreds of pictures of hands to bid and hands to play, he makes the game you once thought difficult into a game that becomes surprisingly easy. Mr. Whitehead describes by pictures the methods of finessing, ruffing, sluffing, placing the lead, and dozens of other problems of intricate play that every bridge expert must solve.

COMPLETE INSTRUCTION BOOK

The book is the large 9x12 inch size—printed on fine English finish stock. Send for it today. The price is only 50c while they last.

only
= 50c

EXPERIMENTER PUBLICATIONS, Inc.
Dept. 2408c, 381 Fourth Ave.
New York, N. Y.

Gentlemen:
Enclosed find 50c. (coin or stamps), for which please send me a copy of "Bridge by Whitehead."

Name.....

Street.....

City.....State.....

Radio—the Graf Zeppelin's Only Contact With the World

(Continued from page 119)

American Ships

The Los Angeles, the German-built airship of the American Navy, has a radio room which is very similar in general arrangements to that on the Graf Zeppelin. Intermediate frequency Telefunken transmitting and receiving equipment is also similar to that on the Graf Zeppelin, and has been remarkably efficient, reliable and satisfactory during the nearly five years of operation by our Navy. Extreme distances have, at times, been attained by this equipment. For instance, on her trans-Atlantic delivery flight from Germany in October, 1924, while near Bourdeaux, France, the ship was heard in this country; while cruising in the southern Caribbean Sea in the spring of 1928, the Los Angeles "worked" San Diego and Lakehurst; while several hundred miles off the Atlantic coast in January, 1925, our voice modulator was heard from Maine to Virginia; we were especially pleased on this occasion to have been clearly heard by the Deaf and Dumb School at Mystic, Conn.

In May, 1925, a New York broker carried on a portion of his day's work on the 'Change by radio, from the Los Angeles, while cruising over Pennsylvania.

The American-built Shenandoah, on her west-coast cruise in October, 1924, made remarkable records with a low-power high-frequency set. Nightly she maintained excellent communication with NKF, the Naval Research Laboratory at Bellevue, D. C.; she worked ships in the Pacific as far as 7,000 miles away.

Weather Data

One of the most important functions of the radio department of an airship is the copying of weather data, which is essential to the efficiency operation of these craft. Surface ships in general stick to their courses and "take" whatever weather comes along, while airships, with

their greatly superior speed, can detour around foul weather, and deliberately hunt for fair winds and good weather, both for the sake of the comfort of their passengers, and to best economize time. Airship officers are close students of meteorology. All weather information upon which to base decisions must, of course, under way, get to the ship through the medium of radio. The Los Angeles copies and draws, twice daily, the complete weather map of the United States, together with "upper air" maps, all of this information being broadcast in code from the Navy Station, NAA, at Arlington, near Washington. In addition, other weather data are copied from various Naval stations at intervals during the day.

It may be interesting here to call attention to the fact that in the recent National Balloon Race (from Pittsburgh, May 4), the winning balloon, Navy No. 1, carried a small high-frequency receiver, with which the Navy weather map broadcast was copied; it proved of great help to that balloon.

Conclusion

Radio is of prime importance to airships, both naval and commercial. When our Podunk friend Joe Smith books his passage to the other side, on one of the present-day airships, or on one of the "bigger and better" ones of the future, he will want to have the assurance of at least the same degree of communications service as he would get on a slower and less comfortable surface ship. He will want to send his good-bye messages home, and his dating-up messages ahead; he will probably have business messages to go both ways. And we are confident that Smith, Esq., will find better and quicker communications service than he was accustomed to on the older surface-bound craft.

The Realization of an Aviation-Radio Idea

(Continued from page 151)

for the one-way international broadcast circuits, Walter Lemmon is working up a new program complexion for WRNY. Already, the station has announced that it will broadcast a minimum of jazz music, and that, of the finest. Several companies are now presenting a series of sketches that reflect the highest type of radio showmanship, specially the National Air Transport program, the Transcontinental Air Transport hour, the Curtiss "ground school," to mention but a few. Joseph Bonime, who made a splendid record while handling the Edison Hour previously, will have charge of the musical standards of the station.

For direct spot-interest broadcasts, the running report of the Outboard Race, from Albany to New York, from advices received by a radio-equipped plane flying over the crafts racing down the Hudson River by Arthur H. Lynch reflected enterprise. The Long Island Sound yacht races will be transmitted in the same way at the end of June.

Through all this work, Mr. Lemmon, the dreamer and the doer, has been assisted by several other able minds, having cooperation and guidance of his associates, notably C. W. Cuthell, president of WRNY, C. M. Keyes, president of the N. A. T., and G. C. Wilson, a banker.

(Continued from page 115)
 rics two curved metal strips as shown in Fig. 2. These strips are equal in length to the width of the viewing aperture and are separated about 1/8 inch in the center. The block has a curved slot as shown for mounting to permit it being shifted as will be explained a little later. The arrangement thus provides two contacts which the tinsel on the disk will touch as the disk revolves and closes the circuits that control the motor speed.

The controlling apparatus is connected as shown in Fig. 4. It will be seen that

a resistance of comparatively low value to be found by experiment is connected in series with the Neon lamp. This resistance is shown at N and a condenser, C, is placed in a lead to the disk to which contact is made by a light spring. The contacts mounted above the disk are connected to resistances in the grid leads of two vacuum tubes as shown. The plate circuits of these tubes contain relays, one of which serves to increase the motor speed and the other decrease it by adjusting the resistance in the motor circuit. And that completes the synchronizing mechanism.

As to its operation. Let us assume that the transmitter has sent the syn-

chronising impulse with the result that the neon tube receives likewise an increase in current. This increase of current which should be appreciably greater than the picture impulses causes an increase in the drop of voltage across the resistance N and this voltage change acts across the condenser C to impress an increased voltage on the moving tinsel contact on the receiving disk. Should the receiving disk be in synchronism with the transmitter the contact C will be midway between fixed contacts A and B and no further action results because a change in speed of the disk is unnecessary.

However, should the disk be a little slow then the synchronizing impulse on passing through the condenser finds the contact C touching fixed contact A which causes the grid of Tube E to receive additional voltage resulting in the relay F closing and shorting out a resistance in the motor circuit and speeding up the motor.

Again we find that should the disk be running too fast the other vacuum tube G will be caused to function and its associated relay will break and place additional resistance in the motor circuit to reduce the speed.

The transfer of the controlling impulse in the circuit of the neon tube to the control tubes takes place in accordance with the usual resistance coupling phenomena and it would require some experiment to get the proper values and the resultant voltages correct. The only disadvantage is the lag in the relays. To offset this the contact strips are made adjustable so the block can be shifted to compensate for relay lag.

FIG. 4. THE CONTROLLING APPARATUS FOR OBTAINING SYNCHRONIZATION AND FRAMING OF THE RECEIVED PICTURE

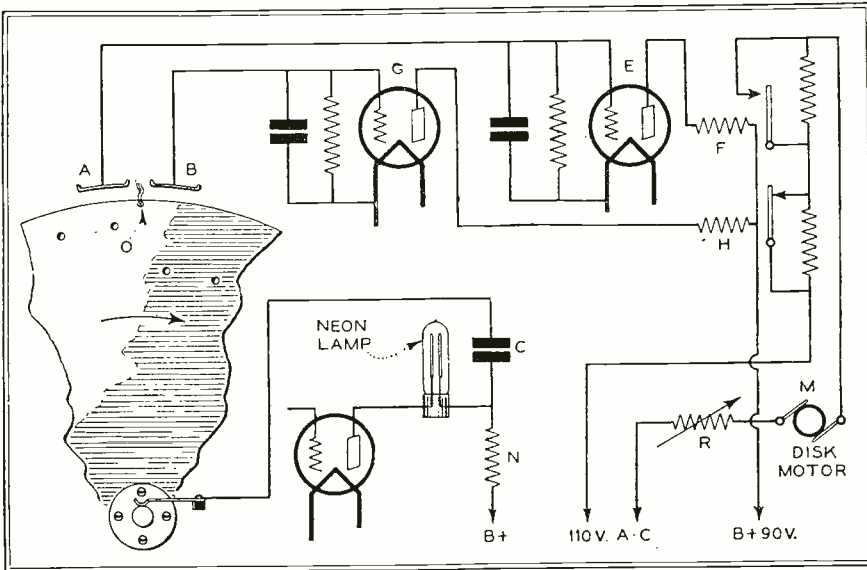

RADIO DIRECTORY

Send for This
 We have a new illustrated catalog showing our up-to-the-minute stock of kits, parts and sets — everything you want in radio — all at dealers' wholesale prices. Write today for Catalog "B-10."
ALLIED RADIO CORPORATION
 711 W. Lake St.
 Dept. "B-10," Chicago, Ill.

The Arc Aerial

 An outside aerial that can be attached in 10 minutes — without climbing on the roof. Write today for details and price.
The Arc-Aerial, Inc.
 Green Bay, Wisconsin

LOWEST PRICES
GREATEST VARIETY



Dealers, write for catalog.
W. C. BRAUN CO.
 552-L Randolph St., Chicago

BIRNBACH

 Moisture-Proof Extension Cords
 Birnbach Extension Cords permit the Loud Speaker to be moved to any room in the house. Attaches instantly. Install a Birnbach Cord and put an end to distortion so often due to badly insulated cords. Your neighborhood dealer has these sizes in stock: 10-20-30-40-50-100 foot lengths. Send for Catalog.
BIRNBACH RADIO CO.
 254 W. 31st St., New York

SEND FOR NEW RADIO BOOK
 All the new hook-ups. Parts, supplies, A.C. sets, television, short wave, etc.
 Write for free copy now.

 18-K Canal Sta., Chicago

The PACENT Super Phonovox
THE WORLD'S LEADING ELECTRIC PICK-UP
PACENT ELECTRIC CO., Inc.
 91 Seventh Avenue, New York

LYNCH
 Resistance-Coupled Amplifier Kit for **TELEVISION** Experimenters
 Contains all essential parts for building a high quality resistance-coupled amplifier unit. Costs less than a good transformer. \$9.00 complete.
ARTHUR H. LYNCH, Inc.
 1775 Broadway New York

RADIO NEWS DIRECTORY
 The most complete catalog of AC sets, parts, accessories, etc. All nationally known at dealers' wholesale prices. **SAVE MONEY.** Write today for your **FREE** Catalog.
SHURE BROS. CO.
 335 W. Madison St.
 Dept. 314 Chicago, Ill.

SEND NOW for New 1929 WESTERN RADIO'S CATALOG
LATEST and FINEST, nationally known A.C. sets, consoles, cabinets, speakers and accessories at **LOWEST PRICES.** Catalog sent **FREE** on request.
WESTERN RADIO MFG. CO.
 128 W. Lake St.
 Dept. RND-8 Chicago

Send 25 cents cash or stamps for 64-page Power Amplifier Manual describing all A. C. and D. C. amplifiers for all tubes. Including the new 245 tubes just out.
 Name
 Address
 State
Rawner Radio Co.
 142 Liberty St.
 New York, N. Y.

200,000 RADIO NEWS readers carefully scan the RADIO DIRECTORY every month.
 Your product here, at the lowest cost in the world's largest and most widely read radio magazine.
RATE PER ISSUE—\$25.00 No order for less than three insertions accepted.
RADIO NEWS, 381 Fourth Avenue, New York City Write for Information

A Course in Aviation only 50¢ complete!

Imagine it! Only 50c for this Big Book that tells all about Aviation. Written in plain, understandable language for the beginner.

Chapters by leading authorities, include:

- Principles of Flight
- Types of Aircraft
- Principles of Stability
- How an Airplane is Piloted
- Aircraft Engineering
- Fuselage Design Construction
- Landing Gear
- Propellers
- Parachutes
- How to Become a Flyer
- Etc.

AERO - MECHANICS also contains hundreds of diagrams and pictures which make the study of aviation remarkably easy.

Send for **AERO-MECHANICS** today! It is a way to quickly learn all the things you must know before you can actually fly.

**Clip and Mail
Coupon
Below**



EXPERIMENTER PUBLICATIONS, Inc.
Dept. 2408a, 381 Fourth Avenue
New York, N. Y.

Gentlemen—Please send me a copy of your Big Book **AERO-MECHANICS**. I enclose 50c to pay for it complete.

Name

Street

City State

(Continued from page 169)

3. Public utility companies supplying energy to operate communication apparatus.

All of these types of securities offer tremendous possibilities for investments; the second and third classifications offer-

FROM 1880 TO ABOUT 1898 EUROPE PARALLELED THE UNITED STATES IN THE USE OF TELEPHONES, BUT FROM THEN ON UP TO LAST YEAR THE UNITED STATES HAS FORGED AHEAD, THE DIFFERENCE BEING ABOUT 800%

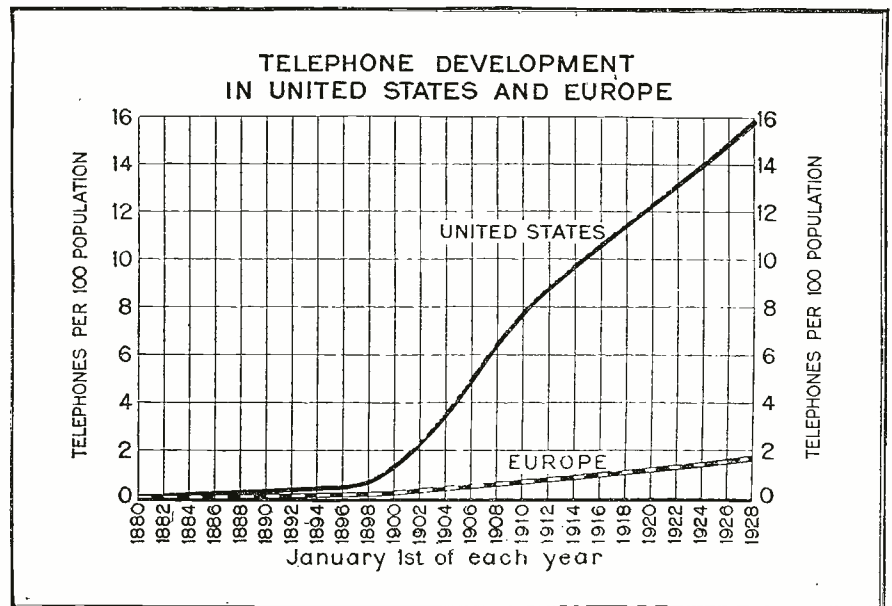

ing more stability than the first, except where the manufacturing of electrical apparatus is for commercial communication purposes, in which case the manufacturing end of the business either controls or

is controlled by the operating end. Obviously, less stability of earnings is associated with companies manufacturing and selling radio and allied merchandise to the public, owing to rapid changes in the art and evolution of design, severe competition and the ever-shifting buying capacity of the public. Yet there have been and will continue to be some exceptionally fine earnings associated with this type of security. Only recently a radio set manufacturing company was able to

INTERPRETED, THE CHART BELOW SHOWS THAT 100 PERSONS IN FRANCE, FOR INSTANCE, HAVE THE USE OF ONLY TWO TELEPHONES, IN GREAT BRITAIN APPROXIMATELY THREE AND ONE-HALF, WHILE IN THE UNITED STATES 100 PERSONS ENJOY THE USE OF SOME FIFTEEN OR MORE

(Continued on page 187)

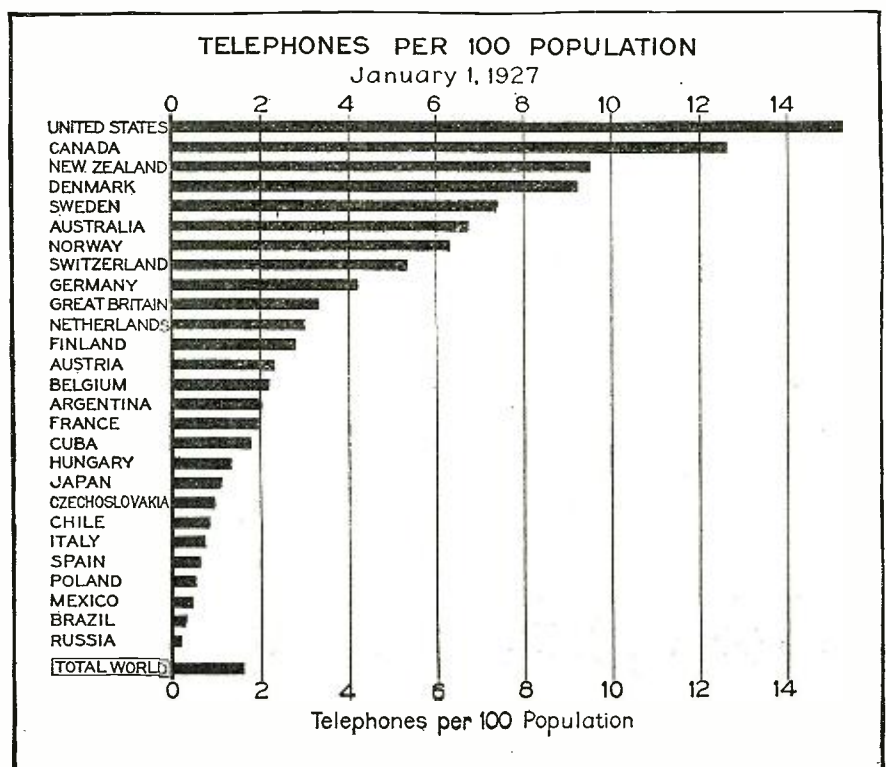

(Continued from page 186)

award a 300 per cent. stock dividend to the holders of its securities. Stocks of other companies have likewise enjoyed sensational rises. Some of these companies will undoubtedly continue to reflect good earnings, while the securities of other companies should also yield good dividends and consequently appreciate in value.

Among radio manufacturing companies, however, the patent situation has been and for some time to come may continue to be a disturbing factor from the standpoint of progress and earnings. For this reason, leaders in the industry have proposed to bring about an interchange of patents so that more stability will enter into this type of security. Without stability, these leaders say, public financing for expansion purposes and public confidence in the permanency of the various companies cannot be enjoyed.

Aside from the temporary difficulties attending the growth of new phases of the electrical communications industry, such as radio broadcasting in the recent past and television in the present and immediate future, the possibilities confronting the growth of the industry as a whole are so stupendous as to challenge the imagination. Let us look into the growth of some of our largest companies operating in the communications field. Great as their growth has been, it is as nothing compared to the extension of electrical communication services that will inevitably develop.

We will begin with the telephone as we know it in America today. The telephone got its corporate start in 1878 when the New England Telephone Company (not the present one) was formed with a capital of \$200,000. Later that year, the Bell Telephone Company was organized to develop service outside of New England. It started with a capitalization of \$450,000. In 1879, a consolidation of these companies was effected and the capital stock increased to \$850,000. Subsequently, the growing interest in the telephone and the possibilities of the business not only enhanced the price of the shares but largely increased the demands for new capital.

To give the original adventurers—they were called speculators in those days—and the inventors some share in the increasing value and to raise the necessary capital for further extension, the American Bell Telephone Company was formed in 1880. This company proceeded with the development of the telephone business of the country on the broad lines originally laid out. It was founded on the policy of one system and universal service, for it was recognized that no aggregation of isolated independent systems could give the public the service that the interdependent, intercommunicating, universal system could give.

By 1899, it was found that the demands of the business required a much larger capital than could be provided under the corporate powers of the American Bell Telephone Company. Therefore, the American Telephone and Telegraph Company—the present, familiar "AT&T"—purchased the American Bell Company on the basis of two shares for one share of American Bell stock.

(Continued on page 188)

A New Screen-Grid Tuner

by Glenn H. Browning and James Millen

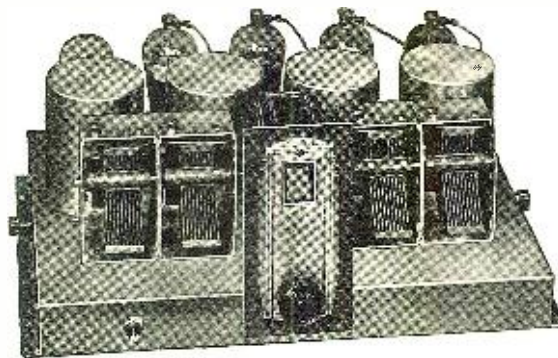

Write for full particulars, mentioning Radio News—today.

Employing 4 A. C. Screen-Grid Tubes with their tremendous R. F. Amplification, this super-sensitive tuner will pull in far distant stations directly through closely crowded locals. All parts mounted on rigidly built frosted aluminum shielded chassis. Uses the new NATIONAL Projector-Type Dial, with color-changing station-selection.

A new Amplifier—Power Supply—the NATIONAL Velvetone, is available for best operation of this remarkable tuner.

NATIONAL SCREEN-GRID MB-29 TUNER

NATIONAL CO. INC., Malden, Mass.

Est. 1914

42 Years
of
Enduring Quality

42 Years
of
Enduring Quality

Public Address Systems

installed with AMPLION sound equipment
Give Superior Performance

With a background of 42 years of success in the acoustic field, Amplion is prepared to offer public address equipment of unsurpassed dependability, for theatres, hotels, auditoriums, hospitals, clubs, railroad depots, county fairs, etc.

WANTED

We need RADIO ENGINEERS in all parts of the country for making Public Address Installations. If interested, file your name, address, training, and experience, together with references, with

PUBLIC ADDRESS
DEPT.

We Have Ready for IMMEDIATE DELIVERY and QUICK INSTALLATION

Group address equipment of unsurpassed reliability as follows:

- Amplion Giant Dynamic Air Column Units
- Amplion Exponential Air Column Horns
- Amplion Exciters
- Amplion Microphones
- Amplion Microphone Amplifiers
- Amplion Electric Phonograph Pick-ups
- Amplion Microphone Mixers

Amplion is the ONE place in America where you can purchase the complete installation or any part of the equipment as desired

Write for new catalog and profitable Amplion proposition to competent engineers

AMPLION CORP. OF AMERICA 133 W. 21st Street, New York

FREE Wholesale Radio Catalog

SEND FOR IT TODAY

Send for our new illustrated catalog of nationally known AC sets, kits, parts, accessories, consoles, etc. All lines at Lowest Wholesale Prices. Write for your FREE copy today.

SHURE BROS. CO.
Dept. 313 335 W. Madison St. CHICAGO, ILL.

Improve your reception with the

Carborundum Detector

Reg. U. S. Pat. Off.

Now It's Adjustable—used by noted circuit designers

THE CARBORUNDUM COMPANY
Dept. D-1 Niagara Falls, N. Y.

PROTECT YOUR RADIO

USE THE
CORWICO
VULCAN
LIGHTNING ARRESTER

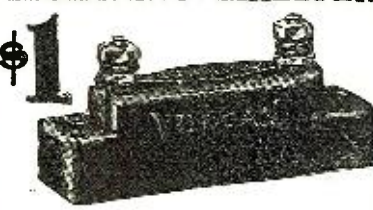

\$1

It Also Dissipates
Accumulated Static Charges

Why take chances of having your radio damaged and put out of use by storms and lightning when you can have guaranteed lightning protection for only \$1.00?
Any radio equipped with a Corwico Vulcan Lightning Arrester that is damaged by lightning will be repaired by us up to a cost of \$100. Get a Corwico Vulcan Lightning Arrester today. Tomorrow may be too late.

At your dealers or direct upon receipt of price

CORNISH WIRE COMPANY
24 Church Street New York City

MAKERS OF
CORWICO BRAIDITE HOOK UP WIRE

(Continued from page 187)

Today, the Bell system (AT&T) has assets of more than \$4,000,000,000. Between the years 1922 and 1927 this corporation's business grew more than 29 per cent. On March 31st there were more than 14,784,000 subscribers to this company's service, which, including 4,670,000 subscribers of other local or independent though connecting companies, affords any one of these 19,554,000 subscribers opportunity to talk with any other subscriber at a moment's notice. Location or distance doesn't mean anything to King Telephone. That a tremendous use is made of the telephone is attested by the number of calls made daily throughout the Bell system. Last year they averaged more than 78,000,000 every day and the expenses for carrying them on amounted to \$2,200,000 daily.

At this writing, there are about 33,250,000 telephones in use throughout the world. Of this number approximately 28,200,000, or 85 per cent., are either associated with or can be connected with the Bell system. As stated above, 19,554,000 of these telephones are rented to subscribers in the United States, thus showing the tremendous possibilities for development that lie ahead, particularly in foreign fields. Excluding the United States, it has been estimated that the telephone business throughout the rest of the world has been developed only 1.6 per cent.!

The International Telegraph & Telephone Company, with its far-flung telegraphic affiliations and cables and radio and telephone services extending to all parts of the world, is another of the large communication giants. From New York across the American continent, north to Alaska, southwest to the Fiji Islands, to New Zealand, Australia, Borneo, the Philippines, Japan, China, Siberia; from New

York to all parts of South America, Central America, the West Indies; to Europe, Africa—wherever man has ventured in a commercial way, the facilities of this company in one form or another are to be found. The I. T. & T. was incorporated in 1920 as a holding and management company. Its system and its associated and affiliated companies comprise both operating and manufacturing units, and its business is the operation of telephone services outside of the United States, of telegraph and cable systems throughout the world and the manufacture of a complete line of telephone, telephone cable, telegraph and radio equipment. In addition, the company operates its own radio stations in various foreign countries.

From the standpoint of possibilities, the I. T. & T. enjoys advantages second to none. In the United States we have what is known as the White Act, a piece of legislation which forbids the merger of telegraph, cable and radio companies when such mergers are in restraint of competition. However, the I. T. & T. can go ahead with radio projects in other parts of the world and is doing so, adding greatly to the competition of American business. Efforts have been and are still being made to repeal this restrictive legislation so that mergers leading to a unification of wire, cable and radio services throughout the world can be brought about. Add to the advantage thus handed to the I. T. & T. by American legislators the further natural advantages that are inherent in undeveloped or only partially developed countries throughout the world, and the future possibilities of this company will appear most significant. In 1928 the I. T. & T. reports a gain of 118% in gross assets, which was due largely to the acquisition of the Postal Telegraph and affiliated Mackay companies. Since its in-

(Continued on page 189)

To be sure your copy reaches you each month, subscribe to RADIO NEWS, \$2.50 per year.

Experimenter Publications, Inc.
381 Fourth Avenue, New York, N. Y.

INDEX TO ADVERTISERS

PAGE	PAGE	PAGE	PAGE
A	E	M	S
Advance Electric Co..... 191	Electrad, Inc..... 169	Mason, Fenwick & Lawrence.. 189	Samson Electric Co., Inc.
Aero Products, Inc..... 172	Electric Specialty Co..... 189	Midwest Radio Corp'n..... 176	Inside Back Cover
Allied Radio Corporation.... 176-185	Electric Storage Battery		See Jay Battery Co..... 180
American Sales Co..... 175	Co., The..... 168	N	Shure Bros. Co..... 185-187
Amplion Corporation of	Excello Products Corp..... 168	National Carbon Co..... 99	Silver-Marshall, Inc..... 103
America..... 187		National Co., Inc..... 187	Speednut Corp..... 189
Arc Aerial, Inc., The..... 185	F	National Radio Institute	
	Ferranti, Inc..... 176	Back Cover	T
B		National School of Visual	Teleplex Co..... 172
Barawik Co., The.... 169-171-185-191	H	Education, The..... 189	Thomas, C. M..... 173
Better Radio Products..... 171	Hammarlund Mfg. Co..... 174	Norden-Hauck, Inc..... 172	Townsend Laboratories..... 176
Birnback Radio Co..... 185	I		Triad Mfg. Co., Inc.
Braun Co., W. C..... 185	International Resistance Co.... 181	O-P	Inside Front Cover
		Paent Electric Co., Inc..... 185	W
C	J		Western Radio Mfg. Co.... 172-185
Carborundum Co., The..... 187	J-M-P Mfg. Co., Inc..... 168	R	Wireless Eger: Engineering
Celeron Co., The..... 167	Jensen Radio Mfg. Co..... 179	Radiall Co..... 171-180	Inc. 183
Central Radio Labs..... 180		Radio Institute of America.... 101	
Clarostat Mfg. Co., Inc..... 183	K-L	Radio Training Association of	X-Y-Z
Cornish Wire Co..... 188	Lynch Inc., Arthur H..... 185	America 97	X-L Radio Laboratories..... 191
Coyne Electrical School..... 177		Radio World..... 173	Yaxley Mfg. Co..... 169
		Rauner Radio Co..... 185	

(Continued from page 188)

ception the company has been a consistent dividend earner, the dividend and stock rights amounting to more than 12% annually. The total assets of this system at the close of 1928 amounted to \$389,914,333.

Not to be outdone, the Radio Corporation of America stands forth as a company with tremendous possibilities. Organized in 1919, it secured the property and rights of the American Marconi Company and made traffic contracts with the British Marconi Company and the principal radio organizations of Germany and France. This new organization—the R. C. A.—had its inception in the minds of American industrial leaders, and was brought into being mainly to conserve and exploit the inventions or patents held by American electrical manufacturing companies and also to permit the United States to possess and operate an international radio network independent of foreign control.

For diversity of money-making interests, the R. C. A. appears to outdo all other communication companies. It manufactures and sells radio equipment (sets, tubes and loud speakers to the public, and radio communication equipment to foreign governments). It controls numerous basic patents under which a score or more radio set and tube manufacturers are licensed. In the marine communications field, through its subsidiary, the Radiomarine Corporation of America, it had 1,360 American vessels under contract at the end of 1928. Radio equipment for aircraft and airport stations has been designed and is now being manufactured.

Recently, this company inaugurated a transcontinental radio service which provides for transmission of messages from the company's offices in New York, Boston and Washington over the air to San Francisco. But the company cannot go very far in the domestic communications field until the Federal Radio Commission grants the necessary wavelengths by which inter-city communications may be conducted.

In the transoceanic field the R.C.A. is much better situated. It enjoys concessions extending until 1945 with most of the countries in Europe. New direct services will be inaugurated by Radio Communications, Inc., another subsidiary of the R. C. A., during the present year between the United States and Russia, Spain, Czechoslovakia and Chile, bringing the number of foreign countries served by this organization to thirty-six. However, the R. C. A. is forced to operate in direct competition with the I. T. & T. and the Western Union in Europe and South America. But the amusement world in which radio broadcasting and sound-motion pictures fall, apparently is a field of almost unlimited possibilities for this company.

The R. C. A. has been identified with radio broadcasting since its beginning several years ago. In 1926 it brought the National Broadcasting Company with its networks of stations into being. In the early part of 1928 it organized a subsidiary, R. C. A. Photophone, Inc., for the development and distribution of sound-motion picture projection equipment and the recording of sound on films. Con-

(Continued on page 191)

Will You be in the BIG-PAY CLASS when Winter Comes?

ACTUAL MOVIES
Train You at Home
for **BIG-PAY**
JOBS IN
ELECTRICITY

You Are
Trained for
All These
Jobs:

Radio,
Talking-
Movies

Automobile
Electricity,
Drafting

Power Plants
and
Sub-Stations

Telephony
and
Telegraphy

Take the
Film Way to
Bigger Pay

NO MORE "waiting in line" when chilly winds begin to shut off the job supply. Men trained in ELECTRICITY are in demand at big pay all the year round. Decide now to be one of these fortunate men.

An amazing new method has been perfected that trains you quickly for a big pay job in ELECTRICITY. Easier, quicker, better than anything you have ever heard of. We train you through MOTION PICTURES right in your own home. Motion Picture machine given at no extra cost. Thousands of feet of film furnished. You see moving diagrams that simplify electrical principles; moving pictures of giant dynamos; trained electricians on actual jobs. Everything so plain and easy that anyone can understand. This is the modern way to prepare for a job at the top. \$60 to \$150 per week is common. Future unlimited.

You take no risk. We guarantee in writing to give you the training and employment service necessary to land you a better job at bigger pay or it doesn't cost you a penny.

Write Now for FREE Book

If you want to be in the big pay class before winter comes, write now for full information. Big, illustrated book shows hundreds of opportunities open to you in ELECTRICITY. Tells plainly just how this new MOTION PICTURE method trains you for the big pay job you've always wanted. This interesting book is FREE. Merely mail the coupon.

The NATIONAL SCHOOL of VISUAL EDUCATION

"The Film Way to Bigger Pay"

537 S. Dearborn St., Chicago, U. S. A. Dept. 8-N
Send book, "The Film Way to Bigger Pay," with facts about this new, easier way to master electricity.

Name _____ Age _____
St. or R. F. D. _____
City _____ State _____

Avoid
The Long
Cold Wait

EMPLOYMENT
OFFICE
OPEN TAK

Mail the Coupon
TO-DAY

Any A. C. Socket Power Set can be used on D. C. supplies— if an "ESCO" Motor Generator or Dynamotor is used

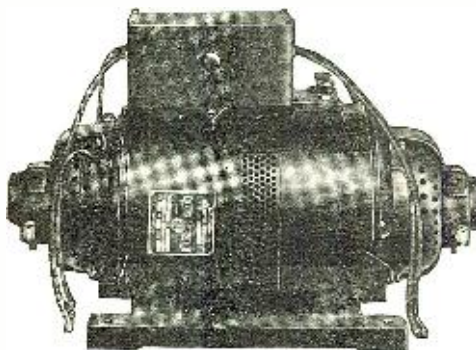

*Motor Generator with Filter
For Radio Receivers*

Machines for operating 60-cycle A. C. Radio Receivers, Loud Speakers and Phonographs from Direct Current Lighting Sockets Without Objectionable Noises of any Kind.

The dynamotors and motor generators are suitable for radio receivers and for combination instruments containing phonographs and receivers. Filters are usually required. The dynamotors and motor generators with filters give as good or better results than are obtained from ordinary 60-cycle lighting sockets. They are furnished completely assembled and connected and are very easily installed.

These machines are furnished with wool-packed bearings which require very little attention, and are very quiet running. Write for Bulletin No. 243-C.

ELECTRIC SPECIALTY COMPANY

211 South Street

Stamford, Conn., U. S. A.

TRADE "ESCO" MARK

*Manufacturers of Motors, Generators, Motor - Generators,
Dynamotors and Rotary Converters for Radio and other purposes*

World's Wonder Wrench

Banishes Old Style Wrenches!

Pays Agents \$20 Daily

New! Different! Never a nut wrench like "Speednut". Chicago Auto Show sensation. Automatic! Ratcheting! Can't slip! The harder it's pulled, the tighter it grips! A whole kit of wrenches in one. Has 23 wonder features. Priced low with big profits to you. Enormous demand. Demonstrator Offer starts you writing orders FREE from tool users, car owners, factories, shops. Part or full time. No stock investment. We deliver. Speednut Corp., 150 N. State St., Dept. 14, Chicago

MASON, FENWICK & LAWRENCE PATENT LAWYERS

600 F. St., N. W., Washington, D. C.

Estb. over sixty years. Send sketches. Electrical, Aeronautical and Chemical Inventions carefully handled. Practice before the U. S. Courts and the Patent Office. Prompt and careful service. Write us. Protect your inventions.

TRADE MARKS REGISTERED

OPPORTUNITY AD-LETS

Follow these advertisements every month. Reliable advertisers from all over the country offer their most attractive specials in these columns.

Classified advertising rate twenty-six cents a word for each insertion. Names and addresses must be included in the above rate. Cash should accompany all classified advertisements unless placed by an accredited advertising agency. No advertisements for less than 10 words accepted.

Objectionable or misleading advertisements not accepted. Advertisements for the October issue must reach us not later than August 1st.

CIRCULATION LARGER THAN THAT OF ANY OTHER RADIO PUBLICATION

EXPERIMENTER PUBLICATIONS, INC., 381 Fourth Avenue, New York, N. Y.

Agents Wanted

Guaranteed Genuine Gold Leaf Letters anyone can put on store windows. Large profits, enormous demand. Free samples. Metallic Letter Co., 422 N. Clark, Chicago.

Aviation

Daring Men Wanted! Learn Aviation with the help of "Aero Mechanics"—the new magazine for men who dare to conquer the air. Send \$1.00 for 6 months' Trial Subscription. Address, Dept. CR, Aero Mechanics, 381 Fourth Avenue, New York, N. Y.

Books

Profitable Home Work. Send 25c for a complete book, "How to Make It." Tells you how to make 101 things you've always wanted. Send coin or stamps to Dept. CR, Experimenter Publications, Inc., 381 Fourth Avenue, New York, N. Y.

Six Big Movie Novels for \$1.00!!! The Iron Mask, The Awakening, Street Angel, Broadway Melody, The Red Dance, and Noah's Ark—6 big novels, all profusely illustrated with pictures taken direct from the movies. Send \$1.00 to Screen Book, Dept. CR, 381 Fourth Avenue, New York, N. Y.

Business Opportunities

Free Book. Start little Mail Order business. Hadwil, 5A-74 Cortlandt Street, N. Y.

Amateur Cartoonists: Sell Your Cartoons. New Plan. Smith's Service EX1194, Wenatchee, Wash.

Inventions Commercialized. Patented or unpatented. Write, Adam Fisher Mfg. Co., 278 Enright, St. Louis, Mo.

A Splendid Side Line—We Sell Pass Books, check covers, coin bags, etc., mainly to banks. They are centrally located and do business quickly. Little time is lost. Our samples are light, compact, easily carried. Sales run into money, items repeat well, commission is liberal, and all paid immediately. We also have an excellent line of advertising novelties for merchants. Our quality is good, and variety extensive, the styles interesting. Line is big enough to devote your whole time if you wish. We are manufacturers, own our buildings, been in business fifteen years, make thirteen thousand sales a year, ship to every state. You could work wherever you happen to be. Correspondence invited. Continental Bank-Supply Co., Mexico, Missouri.

Correspondence Courses

Used correspondence school courses sold on repurchase basis. Also rented and exchanged. Money-back guarantee. Catalog free. (Courses bought.) Lee Mountain, P'gsh, Alabama.

Detectives

Detectives Needed Everywhere. Travel. Experience unnecessary. Particulars Free. Write. American Detective System, 2190 Broadway, New York.

For Inventors

Inventions Commercialized. Patented or unpatented. Write, Adam Fisher Mfg. Co., 278 Enright, St. Louis, Mo.

Help Wanted—Instruction

Wonderful Opportunities in Government Jobs for Men—Women, 18-55; \$125-\$250 month. About 40,000 openings yearly. Are you eligible? We advise you Free. Write, Instruction Bureau, 251 St. Louis, Mo.

Miscellaneous

Become a Bridge Expert—Learn by Whitehead's New Picture Method. It teaches you in a few hours. Complete book of lessons in two colors, well illustrated—only 50c. Send stamps or coin to Experimenter Publications, Inc., Dept. CR, 381 Fourth Avenue, New York, N. Y.

Inventions Commercialized. Patented or unpatented. Write, Adam Fisher Mfg. Co., 278 Enright, St. Louis, Mo.

Learn the Future! Send only \$1.00 for six months' Trial Subscription to "Amazing Stories." The leading imaginative minds of the world write for it. Let them tell what the future may hold for you. Address, Dept. C, Amazing Stories, 381 Fourth Avenue, New York, N. Y.

Patents

Inventions Commercialized. Patented or unpatented. Write, Adam Fisher Mfg. Co., 278 Enright, St. Louis, Mo.

Patent Attorneys

Patents—Send for form "Evidence of Conception" to be signed and witnessed. Form, fee schedule, information free. Lancaster and Allwine, Registered Patent Attorneys in United States and Canada, 209 Ouray Bldg., Washington, D. C.

Patents—Write for Free Instructions. Send Drawing or Model for Examination. Carl Miller, Registered Patent Attorney (former Patent Office Examiner), 262 McGill Building, Washington, D. C.

Inventors—Should write for our Guide Book, "How to Obtain a Patent," and Record of Invention Blank, sent Free. Send model or sketch of inventions for our inspection and instructions free. Radio, Electrical, Chemical, Mechanical and Trademark Experts. Terms Reasonable. Victor J. Evans & Co., 922 Ninth, Washington, D. C.

Patent Attorneys (Cont'd)

Patents—Send drawing or model of your invention for examination and instructions. Advice and booklet free. Highest references. Best results. Promptness assured. Watson E. Coleman, Patent Lawyer, 724 9th Street, N. W., Washington, D. C.

Printing, Engraving and Multigraphing

Multigraphing, two dollars thousand. Miscellaneous Printing. Mayer Ray Corporation, Monmouth, Illinois.

Radio

Burnt Out Audio Transformers repaired, 50 cents each, guaranteed one year. John B. Spangler, Jeffersontown, Ky.

Machined Castings, Blueprint, Instructions for Building Dynamic Speaker \$8.50. A. C. Klein Co., 1058 North 10th, Reading, Penna.

Wanted: Men to work with National Radio Service organization. No selling scheme. Radio Doctors, Inc., Dept. N., Essex St., Salem, Mass.

Salesmen Wanted

Screw-holding Screw Driver! Sells \$1.50. Factories, garages, mechanics, electricians, radio buy on sight! Exclusive territory; free trial offer! Jiffy, 1119 Winthrop Bldg., Boston.

Song Poems

Song Poem Writers: "Real" Proposition. Hibbler, D7X, 2104N, Keystone, Chicago.

Song Writers

Songwriters: Substantial Advance Royalties are paid on publisher's acceptance. Write for Free Booklet on developing ideas for song words or music required by Talking Pictures. Newcomer Associates, 1674 Broadway, New York.

Telegraphy

Telegraphy—Both Morse and Wireless taught thoroughly. Big salaries. Wonderful opportunities. Expenses low, chance to earn part. School established fifty years. Catalog free. Dodge's Institute, Cour St., Valparaiso, Ind.

(Continued from page 189)

tracts have been made with the Radio-Keith-Orpheum Corporation for the furnishing of Photophone equipment to theatres owned or controlled by that company. Contracts have also been executed for the installation of Photophone equipment in approximately one hundred other theatres. In addition, the R. C. A. has effected a merger with the Victor Talking Machine Company. It is of course looking forward to the day when television shall have been sufficiently developed so that in addition to making and distributing sound-motion pictures in theatres throughout the land it will be able to broadcast the performances of the world's premier artists and the best theatrical plays and other major events as they are being enacted (both sight and sound) to homes which possess equipment specially designed to receive and reproduce such offerings.

The total assets of this corporation (allowing only \$1 for patents and patent rights, although a considerable income is

derived from this source) are, as of December 31, 1928, \$73,250,854. Although no dividend has been paid on the common stock, 7% has been paid on the preferred. But notwithstanding this, the common stock has enjoyed an enormous increase in value in anticipation of future earnings.

Several years ago, according to a story appearing in the press, a woman bought 200 shares of Radio Corporation of America stock, paying therefor \$4 a share. Through some error in the mails, the stock was lost. Recently, 200 shares of new stock were issued to her in lieu of the lost shares, but instead of carrying a market value of \$800, the stock had miraculously appreciated to the amount of \$18,000!

There are several other companies in the electrical communications field whose securities are well worth watching. Whether or not they will make substantial advances or earn good dividends on the investment depends on several factors, one of which is the classification in which they fall.

Radio an Outstanding Example of New Demand

ALTHOUGH the automobile has been cited as one of the factors most influential in changing the habits of the nation, radio is the outstanding example of how demand for a new product may grow, it is declared by the President's Committee on Recent Economic Changes in a report on changes in demand in the past few years.

In the enumeration of changes which occurred during the period covered by the survey, it is said, radio sets furnish the most vivid illustration of a new type of merchandise placed on the market with almost phenomenally rapid increase in demand. The influences of this new medium of communication, furthermore, it is pointed out, ramify widely.

"For the farmers, for example," the committee said, "the radio is not only furnishing news and crop information much more quickly than it hitherto has been available, but is also helping further to break down the differences between the wants and interests of the urban and the rural population. It is tending to make the market for various types of merchandise more homogeneous, since it increases the farmers' receptivity for, and even insistence on, merchandise similar to that bought by urban customers.

"A totally different quarter in which the radio is almost certain to exert an influence, of unforeseen significance, is in such districts as the lower East Side of New York City. On the roof of prac-

tically every tenement house on the lower East Side numerous radio antennae are in evidence, thus indicating that this new means of communication is already extensively installed in homes that so often have been looked upon as being somewhat impervious to the rapid spread of new ideas. The socializing influence and the possible effects of such a development on the standards of living of large numbers of consumers are subjects for interesting speculation.

"The demand for radio sets spread within a few years from the homes of the well-to-do, through the middle-class urban community, to the farmers, in one direction, and to the homes of the tenement dwellers, in another. This spreading of demand resulted in a large volume of sales of radio equipment. Further than that, the use of radio equipment had an effect upon the demand for other types of commodities to which attention was called in broadcasting."

The utilization of radio broadcasting for advertising purposes, the committee believes, has been one of the strongest influences causing its rapid expansion. "This advertising acquainted consumers with radio receiving apparatus, and the programs broadcast by other than radio manufacturers were of a character to stimulate a continually broadening desire for the ownership of radio sets," it is declared.—*Washington Radio News Service.*

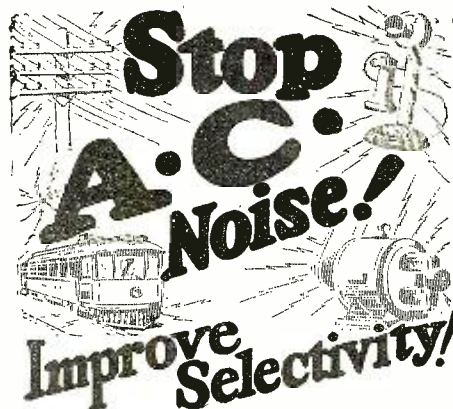

To eliminate "static" from motors, street cars, telephones and electrical appliances, plug in a Falck Claroceptor between wall socket and radio set. This new improvement by a pioneer manufacturer grounds and thus blocks out line interference noise and radio frequency disturbances. Also improves selectivity and distance. Requires no changes in set. Measures just 3 1/2 x 5 1/2 x 2 1/2 inches. Thousands all over America now use the Claroceptor for clearer A.C. reception. Get one right away—at radio parts dealers. Write for descriptive folder.



\$7.50 with cord and plug

Falck CLAROCEPTOR

Manufactured by ADVANCE ELECTRIC CO. 1260 W. Second Street Los Angeles, Cal. JOBBERS AND DEALERS, GET OUR PROPOSITION

X-L VARIO-DENSER

Increase Efficiency and Power of Receiver

X-L Products give accurate values and dependable service. Endorsed by radio engineers, designers and set builders and standard in all best known circuits.



Model "G" Vario-denser

Model "G" with grid clips made in three variable capacity ranges. Price each, \$1.50.

Model "N" has variable capacity, adjustable from 1.8 to 20 micro-micro farads. Price each, \$1.00.

Bakelite insulated X-L Push Post, the most perfect binding post made. Plain or all standard markings. Price each, 15 cents.

Manufacturers of the X-L Link, the 100% Voltage Control and many-purpose Light Socket Adapter.

Write for descriptive literature and free book of circuit diagrams.



SET BUILDERS

Get this Book

LATEST RADIO GUIDE FREE

Barwik, the first and oldest radio specialty house, offers you unusual service this year. Bigger stocks, quicker shipments, lower prices. Deal with an old established, reliable house. Get honest goods, honest service, honest prices. Barwik service makes you more money. Send now for big new Catalog showing lowest wholesale prices.

28-D Canal Sta. CHICAGO, U. S. A.

Mail This Coupon Now for Free Radio Guide

Name _____

Address _____



ORDER NOW AND SAVE MONEY

Here are the popular magazines that live Americans are all reading and talking about. They are offered to you at these special summer bargain prices in order to keep our clerical force busy during our slow season. Take advantage of this situation and benefit through these generous savings by ordering subscriptions for these favorite magazines now.

OFFER NO. 1		
SCIENCE AND INVENTION with PLAIN TALK	}	
Single copy value\$7.20		
Both for only \$5.00		You save \$2.20
OFFER NO. 2		
SCIENCE AND INVENTION with RADIO NEWS	}	
Single copy value\$6.00		
Both for only \$4.00		You save \$2.00
OFFER NO. 3		
SCIENCE AND INVENTION with AMAZING STORIES	}	
Single copy value\$6.00		
Both for only \$4.00		You save \$2.00
OFFER NO. 4		
SCIENCE AND INVENTION with COMPLETE NOVEL	}	
Single copy value\$6.00		
Both for only \$4.00		You save \$2.00
OFFER NO. 5		
SCIENCE AND INVENTION with DETECTIVE NOVEL	}	
Single copy value\$6.00		
Both for only \$4.00		You save \$2.00

OFFER NO. 6		
SCIENCE AND INVENTION with SCREEN BOOK	}	
Single copy value\$6.00		
Both for only \$4.00		You save \$2.00
OFFER NO. 7		
PLAIN TALK with RADIO NEWS	}	
Single copy value\$7.20		
Both for only \$5.00		You save \$2.20
OFFER NO. 8		
PLAIN TALK with SCREEN BOOK	}	
Single copy value\$7.20		
Both for only \$5.00		You save \$2.20
OFFER NO. 9		
PLAIN TALK with COMPLETE NOVEL	}	
Single copy value\$7.20		
Both for only \$5.00		You save \$2.20
OFFER NO. 10		
PLAIN TALK with DETECTIVE NOVEL	}	
Single copy value\$7.20		
Both for only \$5.00		You save \$2.20

CLIP HERE AND MAIL PROMPTLY

THE low prices for these attractive magazine combinations will be withdrawn without notice, so protect yourself on these big savings and send your subscription order at once on the convenient order form opposite.

EXPERIMENTER PUBLICATIONS, INC.
381 Fourth Ave., New York City, N. Y.

Gentlemen: Please enter my order at the special summer bargain prices offered and enclosed find \$..... for the following magazine subscriptions. (Order by number as listed.)

Send Offers Nos.

To

Address

City State

Send Offers Nos.

To

Address

City State

Subscriptions will be accepted for United States and possessions only

RN-8-29

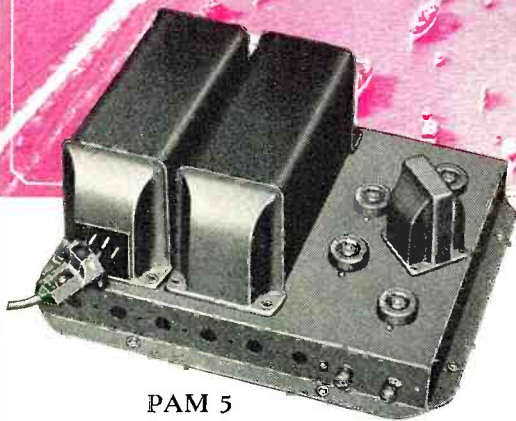

PAM 5

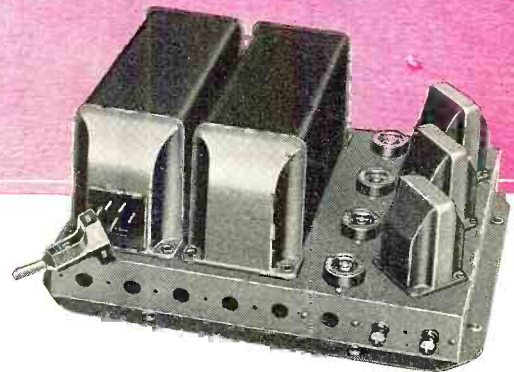

PAM 25

PAM

Keeps Pace With the Best

PAMS kept thousands along the shore of Biscayne Bay in constant touch with every phase of the International Boat Race pictured above. The voice of the announcer was easily heard above the roar of the giant motors used by Gar Wood and Seagrave. Wherever speed kings reign—on track, or ice or sea—in this and other lands, there you will find PAMs, which tell the crowds every detail of the contest.

Pictured above are two new PAMs, the PAM-5 which uses one 227, one 280 and two 112s, and is designed to work out of the detector tube of a radio set, a magnetic phonograph pickup, or microphone amplifier. Its output is such that it will feed any number of PAM-25s, according to power output required for a particular installation. The PAM-25 uses two 281s and two 250s. When used in conjunction with a PAM-5,

it has a power output of 14 watts. Multiples of this undistorted output can be had by the addition of each PAM-25.

A new 16-page bulletin giving mechanical and electrical characteristics, representative installations, and many new PAM amplifiers will be sent upon receipt of 10 cents in stamps to cover postage. Ask for Bulletin No. RN1, when writing.

Main Office:
Canton, Mass.

Samson Electric Co.

Manufacturers Since 1882



Factories at Canton
and Watertown, Mass.

I Will Train You at Home to Fill a Big-Pay Radio Job



Here's the PROOF



\$375 in One Month's Spare Time
"Recently I made \$375 in one month in my spare time installing, servicing, selling Radio sets. I have earned enough in one week to pay for my course."
Earle Cummings,
18 Webster St.,
Haverhill, Mass.

Jumped From \$35 to \$100 a Week
"Last week I had the pleasure of earning \$110 servicing and selling Radio sets. I have made as high as \$243 in two weeks. Before entering Radio I was making \$35 a week. It is certainly great sport to do this kind of work."
J. A. Vaughn,
4202 Arsenal St.,
St. Louis, Mo.



\$450 a Month
"I am operating KGFI. In addition I work in the largest and best equipped Radio shop in the southwest. I am averaging \$450 per month."
Frank M. Jones,
922 Guadalupe St.,
San Angelo, Texas.

If you are earning a penny less than \$50 a week, send for my book of information on the opportunities in Radio. It's FREE. Clip the coupon NOW. A flood of gold is pouring into Radio creating hundreds of big pay jobs. Why go along at \$25, \$30 or \$45 a week when the good jobs in Radio pay \$50, \$75 and up to \$250 a week? "Rich Rewards in Radio" gives full information on these big jobs and explains how you can quickly learn Radio through my easy, practical home-study training.

Salaries of \$50 to \$250 a Week Not Unusual

The amazing growth of Radio has astounded the world. In a few short years three hundred thousand jobs have been created. And the biggest growth is still to come. That's why salaries of \$50 to \$250 a week are not unusual. Radio simply hasn't got nearly the number of thoroughly trained men it needs.

You Can Learn Quickly and Easily in Spare Time

Hundreds of N. R. I. trained men are today making big money—holding down big jobs—in the Radio field. You, too, should get into Radio. You can stay home, hold your job, and learn in your spare time. Lack of high school education or Radio experience are no drawbacks.

Many Earn \$15, \$20, \$30 Weekly on the Side While Learning

I teach you to begin making money shortly after you enroll. My new practical method makes this possible. I give you SIX BIG OUTFITS of Radio parts and teach you to build practically every type of receiving set known. M. E. Sullivan, 412 73rd St., Brooklyn, N. Y., writes, "I made \$720 while studying." G. W. Page, 1807 21st Ave., S. Nashville, Tenn. "I picked up \$935 in my spare time while studying."

Your Money Back If Not Satisfied

My course fits you for all lines—manufacturing, selling, servicing sets, in business for yourself, operating on board ship or in a broadcasting station—and many others. I back up my training with a signed agreement to refund every penny of your money if after completion you are not satisfied with the lessons and instructions I give you.

Act NOW—64-Page Book is FREE

Send for this big book of Radio information. It has put hundreds of fellows on the road to bigger pay and success. Get it. See what Radio offers you, and how my Employment Department helps you get into Radio after you graduate. Clip or tear out the coupon and mail it RIGHT NOW.

J. E. SMITH Pres.,
Dept. 9VT,
National Radio
Institute,
Washington, D. C.

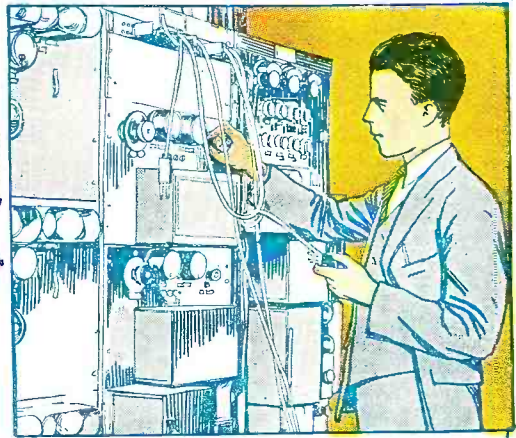

You can build
100 circuits with
the six big outfits
of Radio parts
I give you



3 of the 100 you
can build

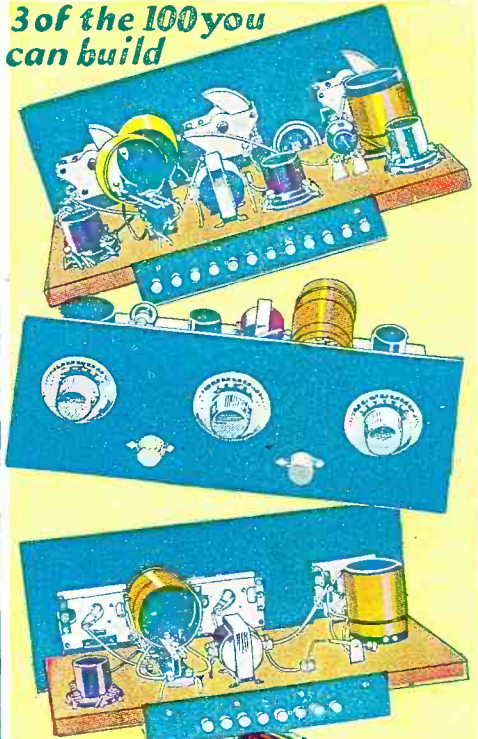

Find out quick
about this
practical way
to big pay



Mail This FREE COUPON Today

J. E. Smith, President,
Dept. 9VT, National Radio Institute,
Washington, D. C.

Dear Mr. Smith:—Send me your FREE book "Rich Rewards in Radio," giving information on the big money opportunities in Radio and your practical method of teaching with six Radio Outfits. I understand this places me under no obligation.

Name Age.....
Address
City State.....

Employment Service to all Graduates
Originators of Radio Home Study Training